

CTMCA3216 Series

SPECIFICATIONS

Part Number	Frequency Range (MHz)	Peak Gain (XZ-V)	Average Gain (XZ-V)	Return Loss	Impedance (Ω)
CTMCA3216-2R4	2400~2500	0.5 dBi typ.	-0.5 dBi typ.	9.5 dB min.	50
CTMCA3216-4R9	4900~5900	2.0 dBi typ.	-2.5 dBi typ.	9.5 dB min.	50

PHYSICAL DIMENSIONS

Size	A	B	C	D
mm	3.20±0.2	1.60±0.2	1.3+0.1/-0.2	0.5±0.3
inches	0.126±0.008	0.063±0.008	0.051+0.004/-0.008	0.020±0.012

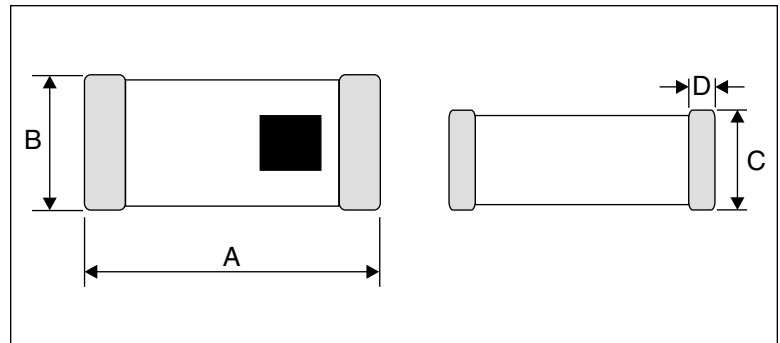
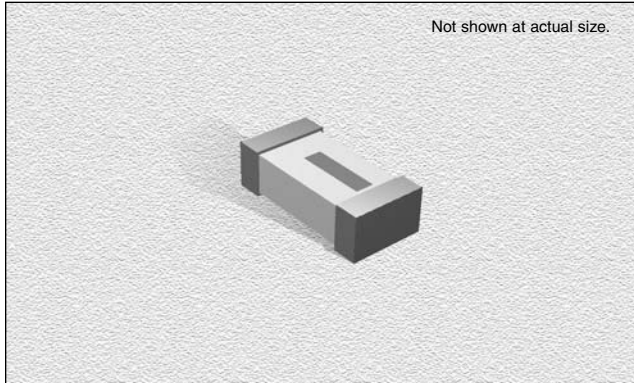

CHARACTERISTICS

Description: Multi-layer Chip Antenna

Features: Monolithic SMD type. Wide bandwidth

Applications: WLAN, Home RF, Bluetooth Modules, etc.

Operating Temperature: -40°C to +85°C

Storage Temperature: -40°C to +85°C

Input Power: 500mW Max.

Packaging: Tape & Reel

Additional Information: Additional electrical & physical information available upon request

Samples available. See website for ordering information.

11.17.04

Typical Radiation Patterns

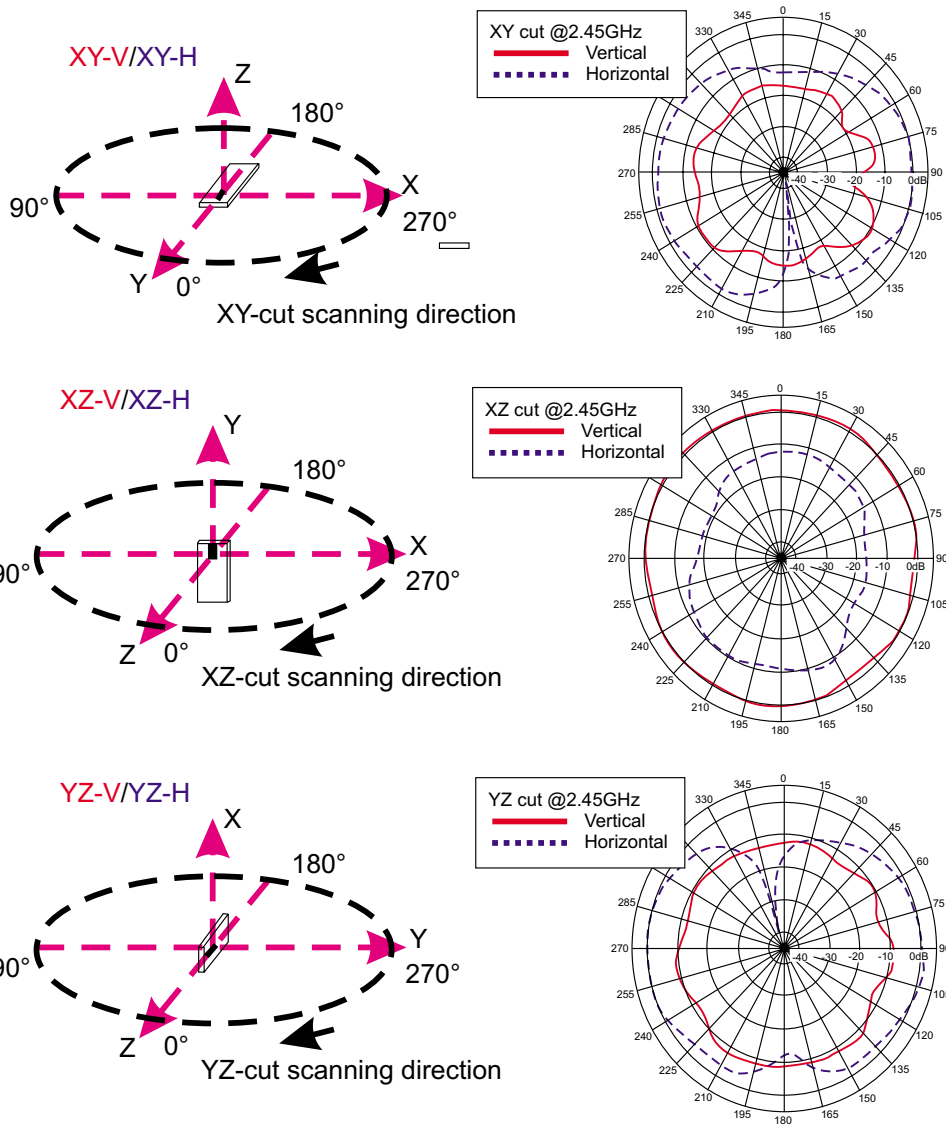

11.17.04

Typical Electrical Characteristics (T=25°C)

Test Board:

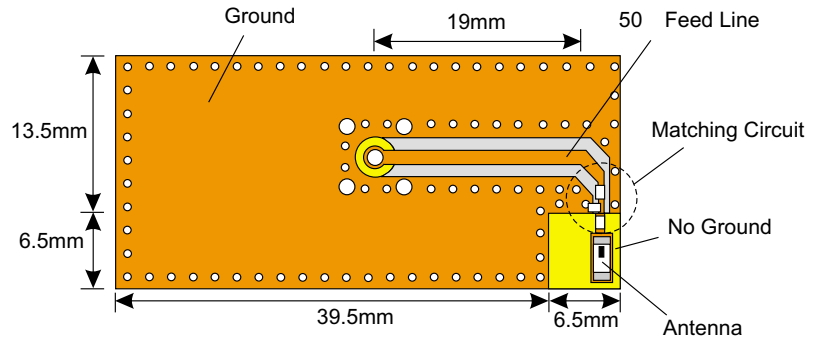

Return Loss

a) Without Matching Circuits

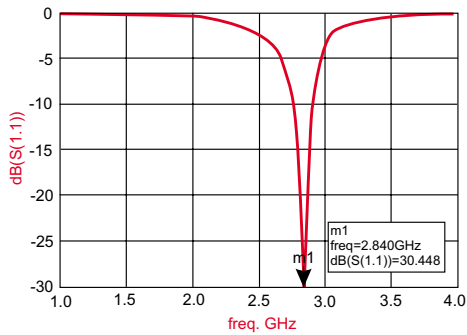

b) With Matching Circuits

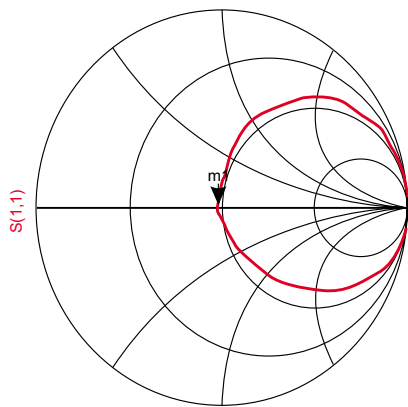
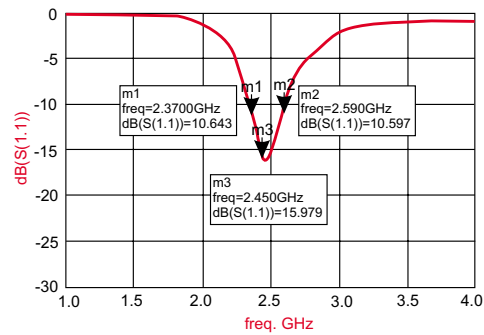

freq. (1.000GHz to 4.000GHz)

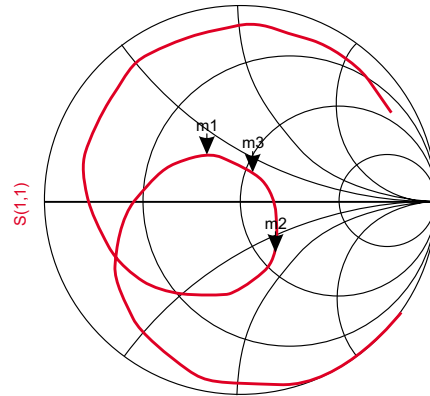

freq. (1.000GHz to 4.000GHz)

11.17.04

Typical Radiation Patterns

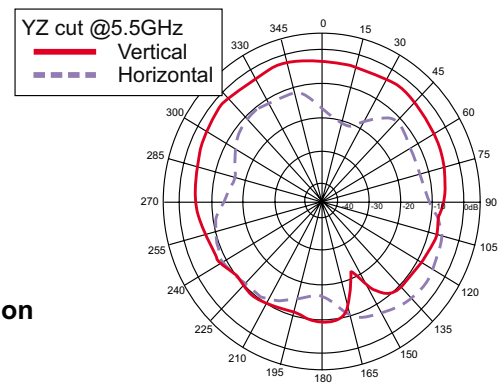
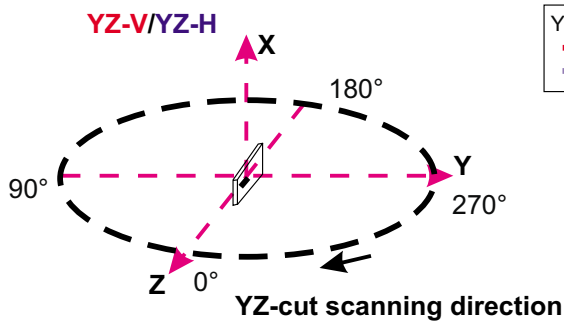
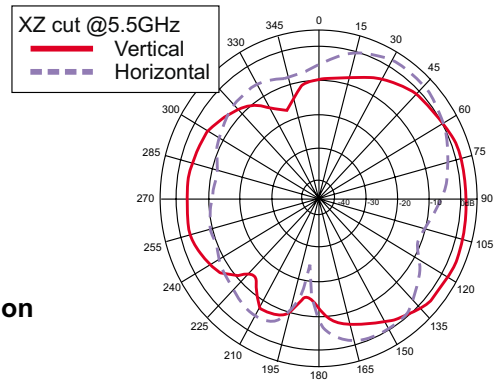
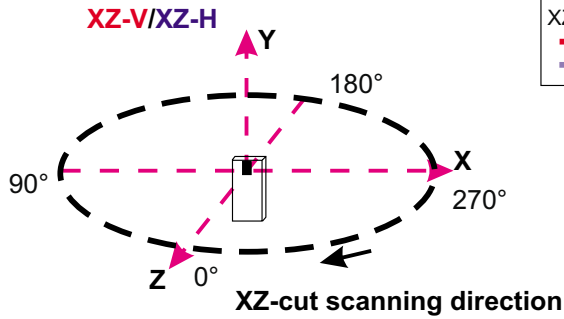
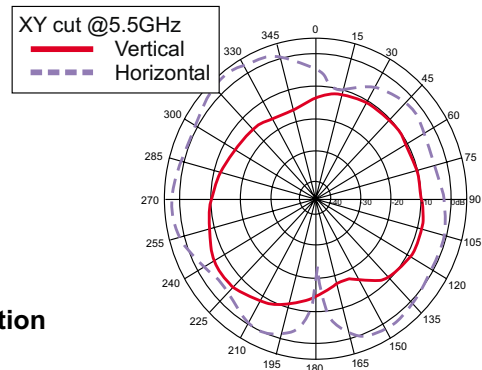
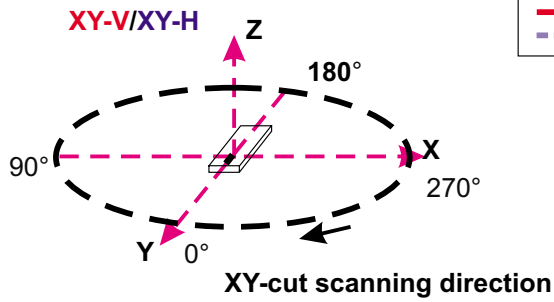

11.17.04

CTMCA3216-4R9

Typical Electrical Characteristics (T=25°C)

Test Board:

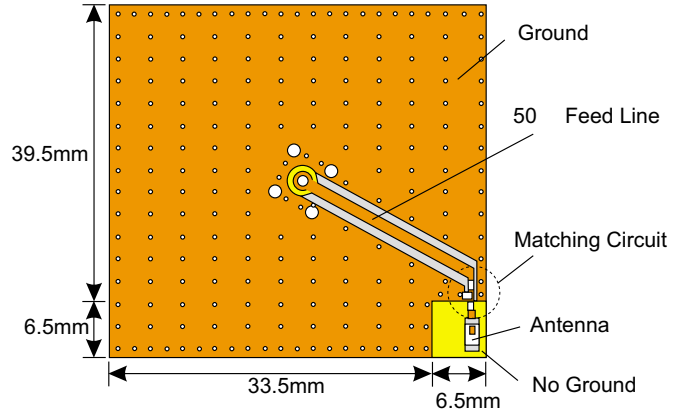

Return Loss

a) Without Matching Circuits

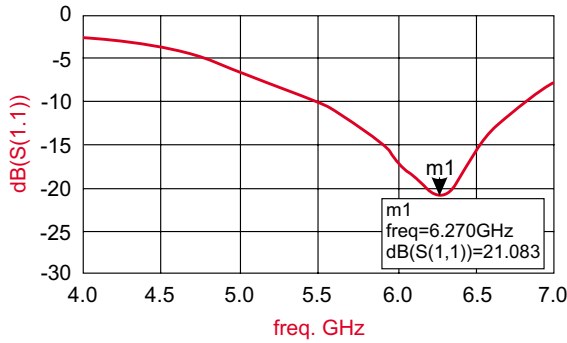

b) With Matching Circuits

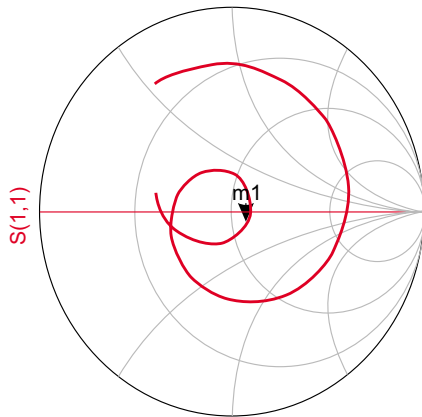
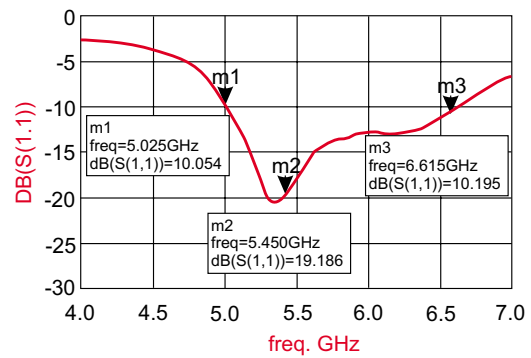

freq (4.000GHz to 7.000GHz)

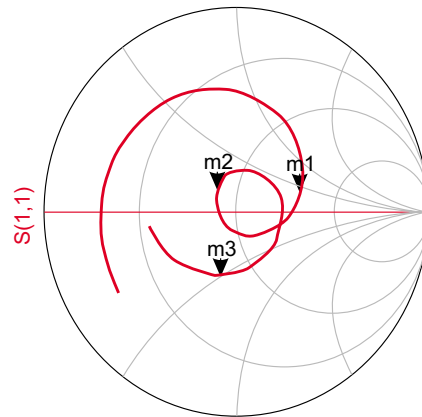

freq (4.000GHz to 7.000GHz)