

CX1VSM CRYSTAL

10 kHz to 600 kHz
Miniature Surface Mount
Quartz Crystal for Pierce Oscillators

DESCRIPTION

The CX1VSM quartz crystal is a high quality tuning fork resonator for use in Pierce (single inverter) oscillators. The CX1VSM is hermetically sealed in a rugged, miniature ceramic package. The CX1VSM crystal is manufactured using the STATEK-developed photolithographic process, and was designed utilizing the experience acquired by producing millions of crystals for industrial, commercial, military and medical applications. Maximum process temperature should not exceed 260°C.

FEATURES

- Miniature tuning fork design
- High shock resistance
- Designed for low power applications
- Compatible with hybrid or PC board packaging
- Low aging
- Full military testing available
- Ideal for battery operated applications
- Designed and manufactured in the USA

EQUIVALENT CIRCUIT

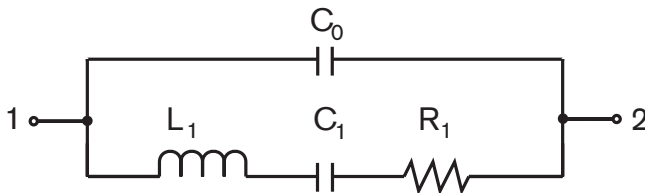

R_1 , Motional Resistance L_1 , Motional Inductance
 C_1 , Motional Capacitance C_0 , Shunt Capacitance

SUGGESTED LAND PATTERN

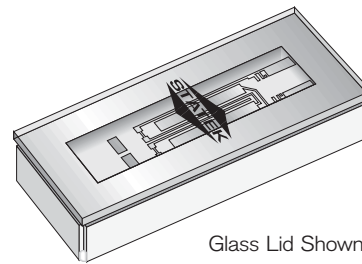
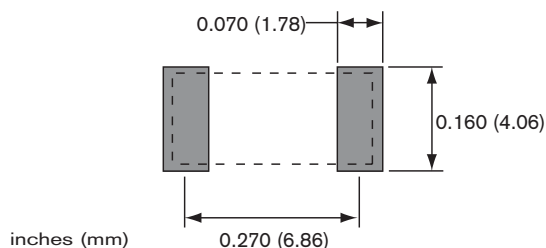

Glass Lid Shown

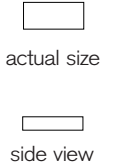

PACKAGE DIMENSIONS

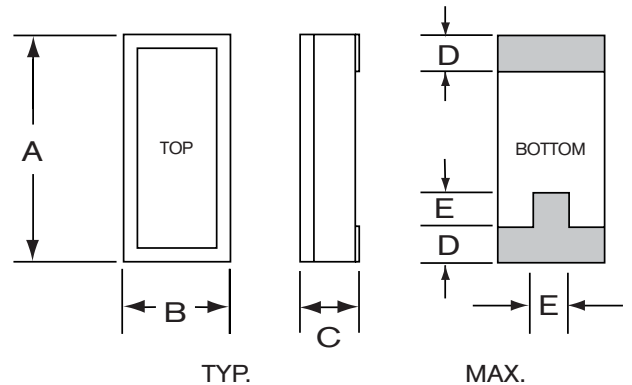

DIM	TYP.		MAX.	
	inches	mm	inches	mm
A	0.315	8.00	0.330	8.38
B	0.140	3.56	0.155	3.94
C	-	-	see below	
D	0.045	1.14	0.055	1.40
E	0.060	1.52	0.070	1.78

DIM "C"	GLASS LID		CERAMIC LID	
	inches	mm	inches	mm
MAX				
SM1	0.065	1.65	0.070	1.78
SM2	0.067	1.70	0.072	1.83
SM3	0.070	1.78	0.075	1.90

CONVENTIONAL CMOS PIERCE OSCILLATOR CIRCUIT

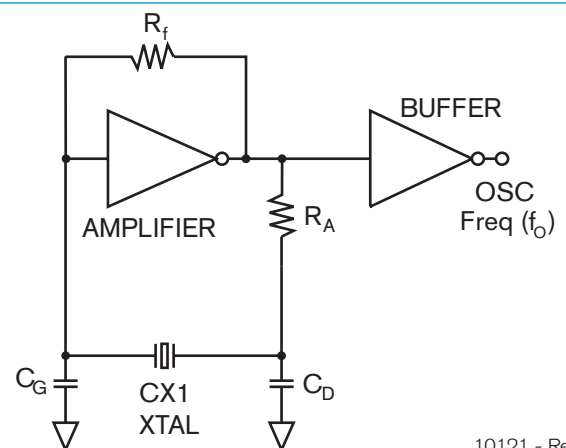

10121 - Rev B



SPECIFICATIONS

Specifications are typical at 25°C unless otherwise noted.
Specifications are subject to change without notice.

Frequency Range	10 kHz to 600 kHz
Standard Calibration Tolerance* (see table below)	
Motional Resistance (R_1)	Figure 1 MAX: 10-169.9 kHz, 2x Typ. 170-600 kHz, 2.5x Typ.
Motional Capacitance (C_1)	Figure 2
Quality Factor (Q)	Figure 3 Min. is 0.25x Typ.
Shunt Capacitance (C_0)	2.0 pF MAX.
Drive Level	10-24.9 kHz 0.5 μ W MAX. 25-600 kHz 1.0 μ W MAX.
Turning Point (T_0)**	Figure 4
Temperature Coefficient (k)	-0.035 ppm/°C ²
Aging, first year	5 ppm MAX.
Shock, survival***	1,000 g, 1ms, 1/2 sine
Vibration, survival***	20 g RMS, 10-2,000 Hz
Operating Temp. Range	-10°C to +70°C (Commercial) -40°C to +85°C (Industrial) -55°C to +125°C (Military)
Storage Temp. Range	-55°C to +125°C
Max Process Temperature	260°C for 20 sec.

* Tighter frequency calibration available.
** Other turning point available.
*** Higher shock and vibration available.

CX1VSM Standard Calibration Tolerance at 25°C

Frequency Range (kHz)			
10-74.9	75-169.9	170-249.9	250-600
± 30 ppm (0.003%)	± 50 ppm (0.005%)	± 100 ppm (0.01%)	±200 ppm (0.02%)
± 100 ppm (0.01%)	± 100 ppm (0.01%)	± 200 ppm (0.02%)	±500 ppm (0.05%)
± 1000 ppm (0.1%)	± 1000 ppm (0.1%)	± 2000 ppm (0.2%)	±5000 ppm (0.5%)

Load Capacitance (C_L), Used to Calibrate CX1VSM (other C_L available)

Frequency Range (kHz)	Load Capacitance (pF)	Frequency Range (kHz)	Load Capacitance (pF)
10-15.9	11	55-99.9	8
16-24.9	10	100-179.9	5
25-54.9	9	180-600	4

HOW TO ORDER CX1VSM CRYSTALS

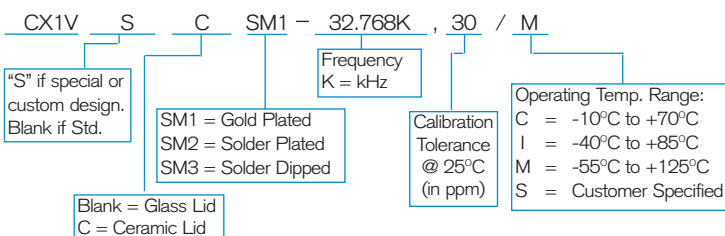

FIGURE 1
CX1V TYPICAL MOTIONAL RESISTANCE (R_1)

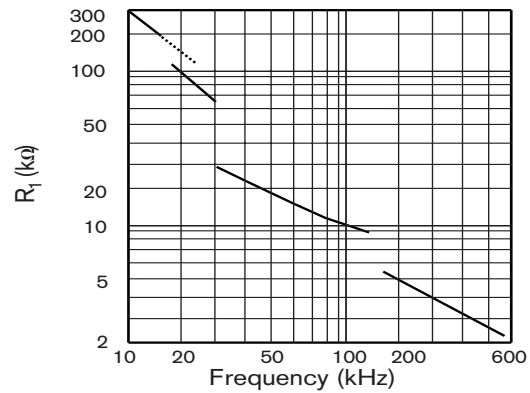

FIGURE 2
CX1V TYPICAL MOTIONAL CAPACITANCE (C_1)

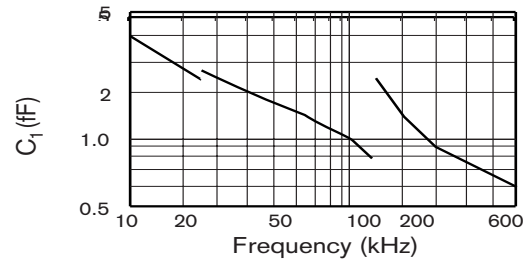

FIGURE 3
CX1V TYPICAL QUALITY FACTOR (Q)

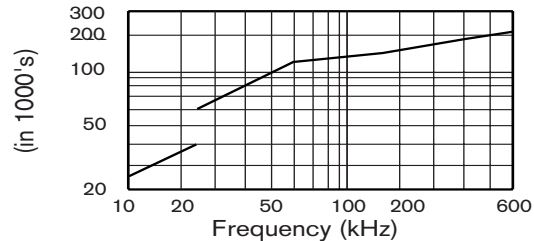
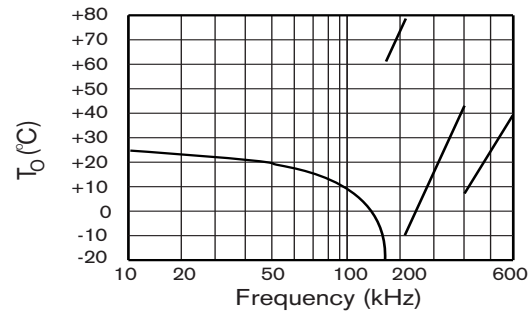

FIGURE 4
CX1V TYPICAL TURNING POINT TEMP. (T_0)



Note: Frequency f at temperature T is related to frequency f_0 at turning point temperature T_0 by: $\frac{f-f_0}{f_0} = k(T-T_0)^2$

TERMINATIONS

Designation	Termination
SM1	Gold Plated
SM2	Solder Plated
SM3	Solder Dipped

PACKAGING OPTIONS

CX1VSM - Tray Pack
- 16mm tape, 7" or 13" reels
(Reference tape and reel data sheet 10109)