

**Over Sampling Digital Filter LSI**

**Description**

The CXD1162P is a digital filter LSI with quadrupled sampling rate, developed for compact disc player.

**Features**

- 83 taps and 21 taps filters linked through cascade connections provide a quadrupled sampling digital filter.
- Built-in filters for 2 channels correspond to L and R.
- A variety of functions, including soft muting.
- 83rd and 21st order filters have 2 modes of filter coefficients each, that enable the selection of the filter characteristics most suitable for usage.

**Function**

- Built-in filters for 2 channels
- Filtering with a quadrupled sampling rate
- 2-stage FIR filters interconnected in cascade (83 taps+21 taps)
- Soft-muting function
- Independent linear interpolation for either L or R, up to 8 words.
- 2 modes of coefficients provided for both 83 taps and 21 taps (See the Filter Characteristics)
- Input/Output format  
 Input: 2's complement MSB first (serial)  
 Output: 2's complement MSB first (serial)

**Structure**

Silicon gate CMOS IC

**Absolute Maximum Ratings (Ta=-20 to +75°C)**

• Supply voltage	V <sub>DD</sub>	-0.5 to +6.5	V
• Input voltage	V <sub>I</sub>	-0.5 to V <sub>DD</sub> +0.5	V
• Allowable power dissipation	P <sub>D</sub>	550	mW (Ta=75°C)
• Storage temperature	T <sub>stg</sub>	-55 to +150	°C

**Recommended Operating Conditions**

• Supply voltage	V <sub>DD</sub>	4.5 to 5.5	V
• Operating temperature	T <sub>opr</sub>	-20 to +75	°C
• OSC frequency	f <sub>x</sub>	10 to 20	MHz

**Package Outline**

Unit: mm

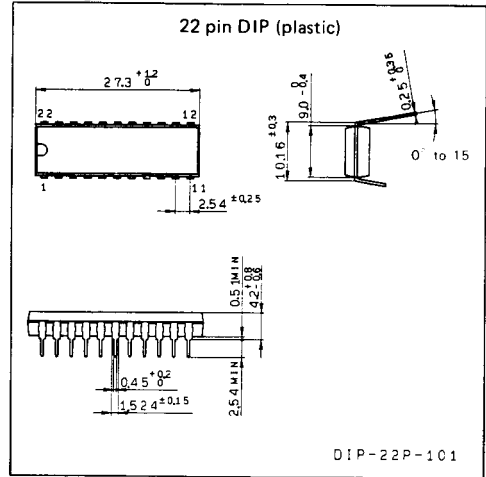

Block Diagram

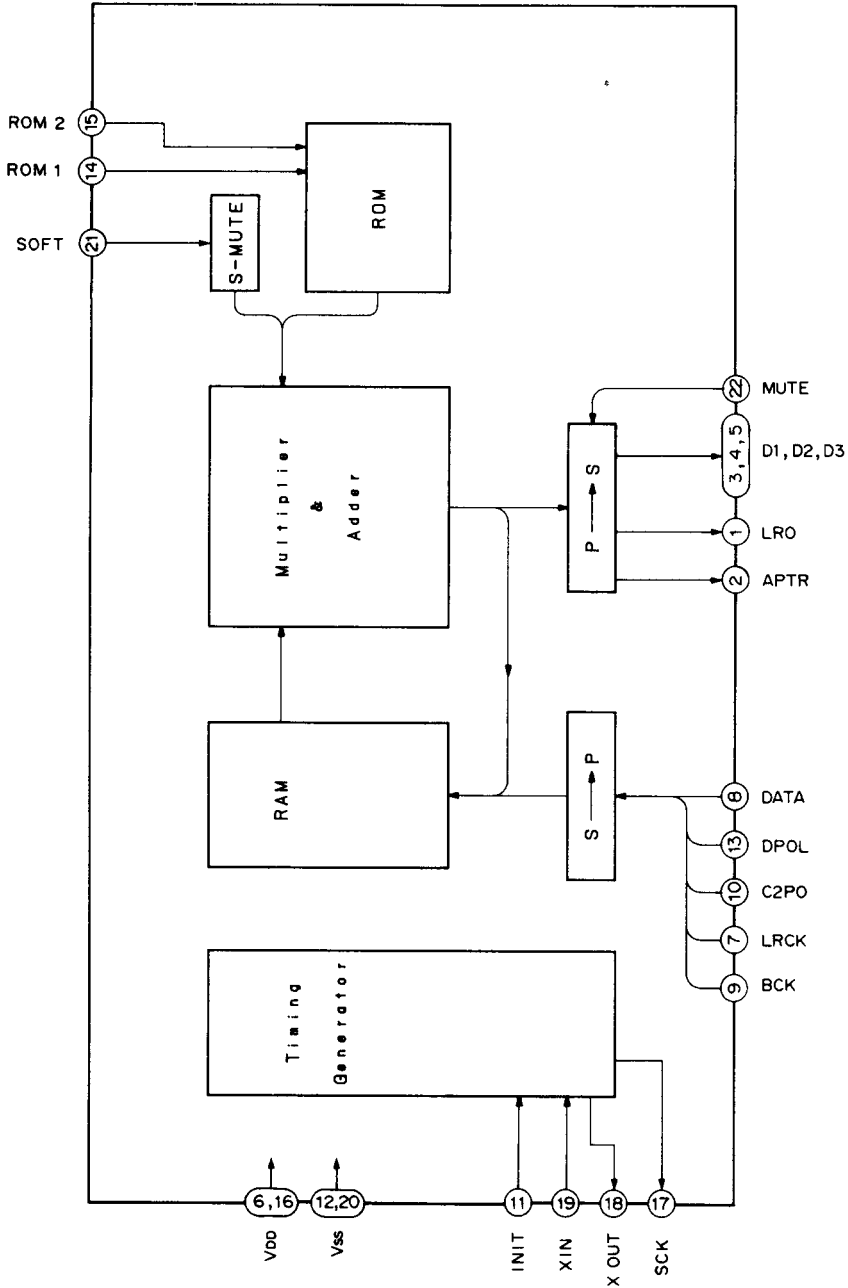

## Pin Configuration and Description (Top View)

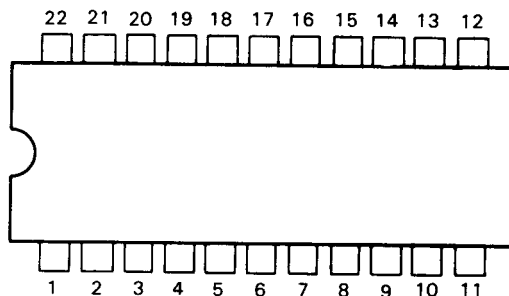

No.	Symbol	I/O	Description
1	LRO	O	LRCK output (4fs)
2	APTR	O	Aperture clock for R aperture
3	D <sub>1</sub>	O	BCK output (4fs)
4	D <sub>2</sub>	O	DATA output (4fs)
5	D <sub>3</sub>	O	WCK output
6	V <sub>DD</sub>	–	Positive supply (+5V)
7	LRCK	I	LRCK input
8	DATA	I	16 bit 2 serial data input 2's complement
9	BCK	I	BCK input
10	C2PO	I	Error flag input
11	INIT	I	Power on reset input. Active at "L"
12	V <sub>SS</sub>	–	Negative supply (0V)
13	DPOL	I	Reverses input data polarity
14	ROM1	I	ROM switching for 83rd order (See the Filter Characteristics)
15	ROM2	I	ROM switching for 21st order (See the Filter Characteristics)
16	V <sub>DD</sub>	–	Positive supply (+5V)
17	SCK	O	System clock output for external IC (384fs)
18	XOUT	O	Output of crystal oscillation circuit (384fs)
19	XIN	I	Input of crystal oscillation circuit (384fs)
20	V <sub>SS</sub>	I	Negative supply (0V)
21	SOFT	I	Soft muting ON/OFF switch. On at "H" level
22	MUTE	I	"H" level

**Electrical Characteristics**

**DC characteristics**

$V_{DD}=4.5$  to  $5.5V$ ,  $T_a=-20$  to  $+75^{\circ}C$

No.	Item	Symbol	Condition	Min.	Typ.	Max.	Unit
19	XIN	$I_{LI}$	$V_1=V_{DD}/OV$	—	—	$\pm 20$	$\mu A$
All inputs	"H" input voltage	$V_{IH}$	—	$0.76V_{DD}$	—	—	V
	"L" input voltage	$V_{IL}$	—	—	—	$0.24V_{DD}$	
	Input leak current	$I_{LI}$	$V_1=V_{DD}/OV$	—	—	$\pm 5$	$\mu A$
	Input capacity	$C_{IN}$	—	—	4	6	PF
1 LRO 2 APTR 4 D1 4 D2 5 D3	"H" output voltage	$V_{OH}$	$I_o=-4$ mA	$V_{DD}-0.5$	—	—	V
"L" output voltage	$V_{OL}$	$I_o=4$ mA	—	—	0.4		
17 SCK	"H" output voltage	$V_{OH}$	$I_o=-5$ mA	$V_{DD}-1.0$	—	—	V
	"L" output voltage	$V_{OL}$	$I_o=5$ mA	—	—	1.0	
	Current consumption	$I_{DD}$	Unload $V_1=V_{DD}/OV$ $f_x=16.93$ MHz	—	—	40	mA

**AC characteristics**

$V_{DD}=4.5$  to  $5.5V$ ,  $T_a=-20$  to  $+75^{\circ}C$

Item	Symbol	Condition	Min.	Typ.	Max.	Unit
Oscillating frequency	$f_x$ t		—	16.9344	20.0	MHz
Input BCK frequency	$f_{BCK}$		—	—	3.5	MHz
Input BCK pulse width	$t_{WIB}$		100	—	—	ns
Input data set-up time	$t_{IDS}$		20	—	—	ns
Input data hold time	$t_{IDH}$		20	—	—	ns
Input LRCK set-up time	$t_{ILRS}$		50	—	—	ns
Input LRCK hold time	$t_{ILRH}$		50	—	—	ns
Output BCK pulse width	$t_{WOB}$	$f_{XT}=16.9344$ MHz $C_L=50$ pF	45	—	—	ns
Output data set-up time	$t_{ODS}$		30	—	—	ns
Output data hold time	$t_{ODH}$		40	—	—	ns

**AC characteristics**

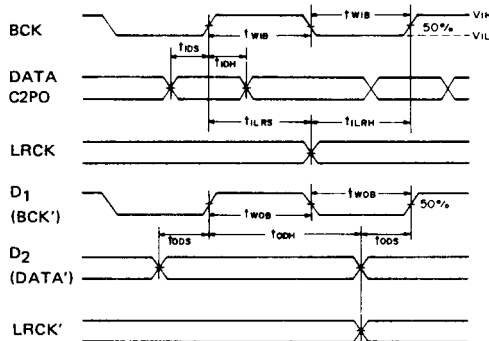

**Description of Functions**

**1. Soft muting**

Mutes or de-mutes output data within approximately 46 mS (2048/fs).

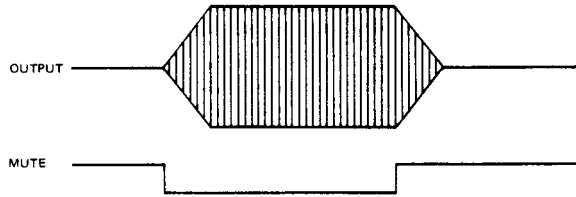

**Fig. 1**

**2. Muting**

When MUTE goes high or INIT goes low, the output is muted.

**3. Data polarity**

Allows switching between inversion and non-inversion of output data.

When DPOL level is "H", the output data is inverted with respect to the input data.

**4. Interpolation**

Error in an input data block consisting of up to eight consecutive data units can be linearly interpolated by two correct data units, namely, the one preceding the erroneous block and the other following it. (This is done separately for L and R.). For errors of more than eight consecutive input data units, only the last eight data are linearly corrected, and all preceding data units are maintained without correction.

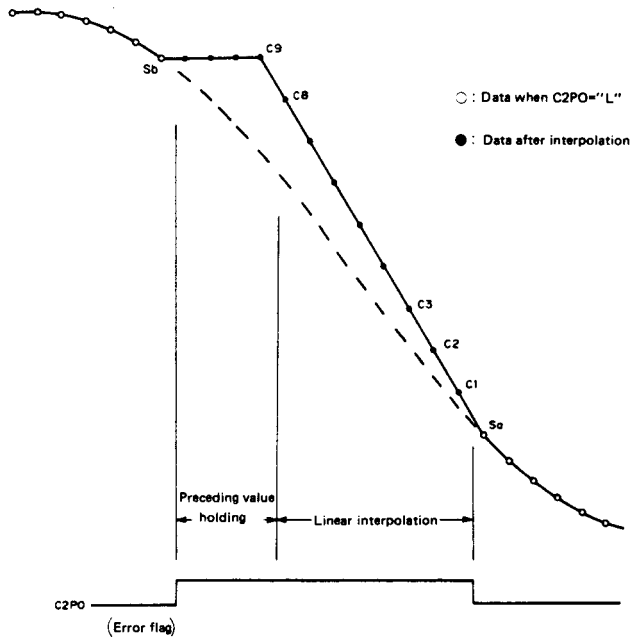

## 5. Input and output

### 1) Input

The changeover point of MSB first serial data ( $f_s$ ) of 2's complement represents the switching of LRCK of this data string, only the data of the last 16-bit clock (BCK) are valid.

When INIT="L" (resetting), the input data are invalid and the input is equivalent to ALL "0".

### 2) Output

MSB first serial data ( $4f_s$ ) of 2's complement clock pulses such as LRO and BCK are output only when resetting is canceled (INIT="H") and MUTE="L". Otherwise, muting remains effective.

## Filter Characteristics

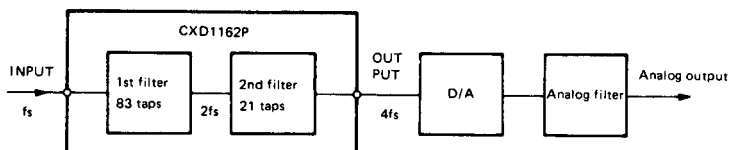

Input spectrum

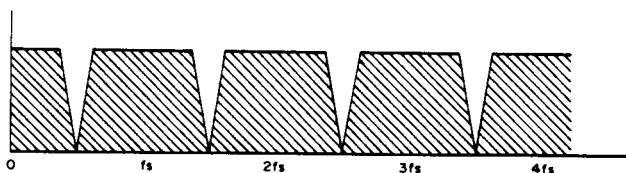

Characteristics of 1st filter

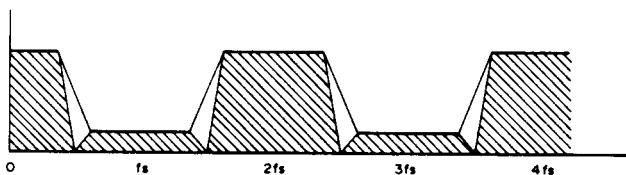

Characteristics of 2nd filter

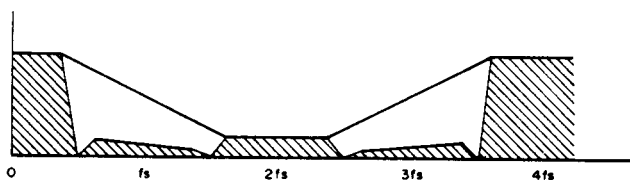

Characteristics of analog filter

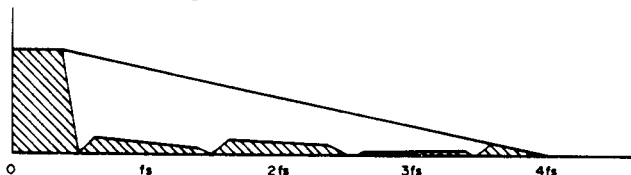

I/O Timing Chart

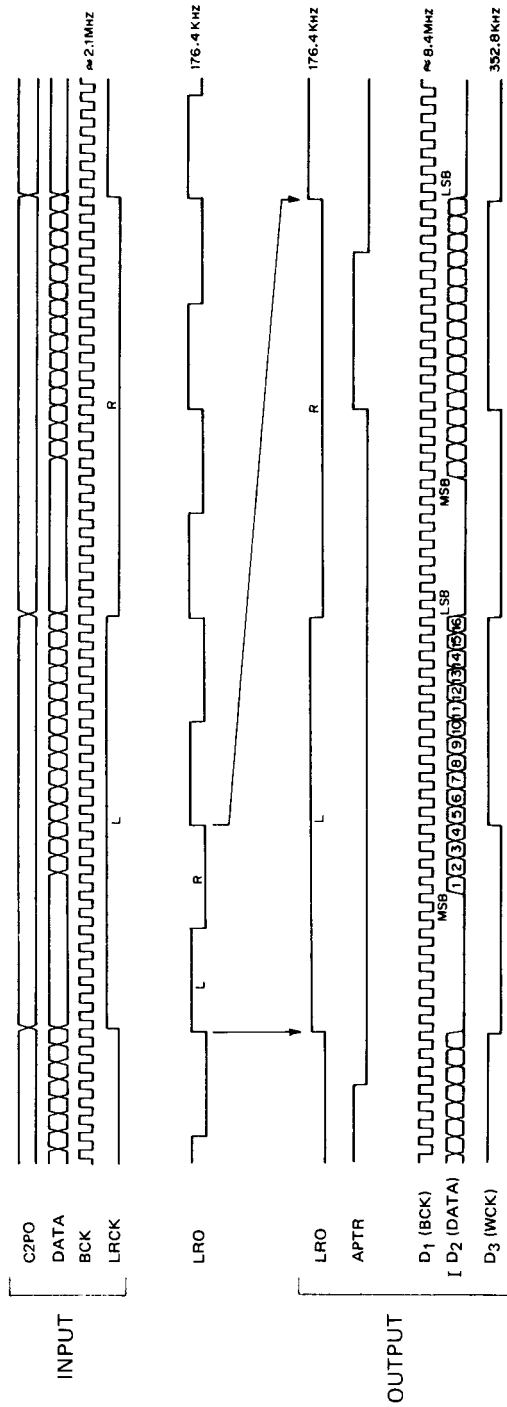

**Combined Filter Characteristics (1st filter+2nd filter)**

1) ROM1="H"

Stop band attenuation: 80 dB Min. (over 25.7 kHz)

Pass band ripple: 0.001 dB Max.

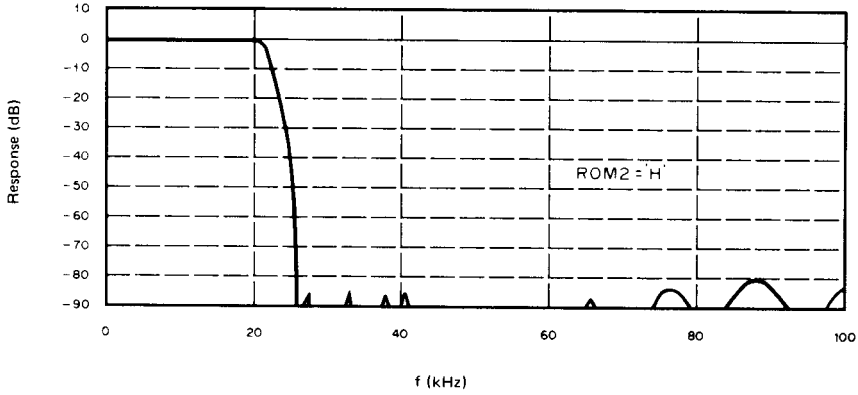

2) ROM1="L"

Stop band attenuation: 60 dB Min. (24.1 kHz); 65 dB Min.

Pass band ripple: 0.004 dB Max.

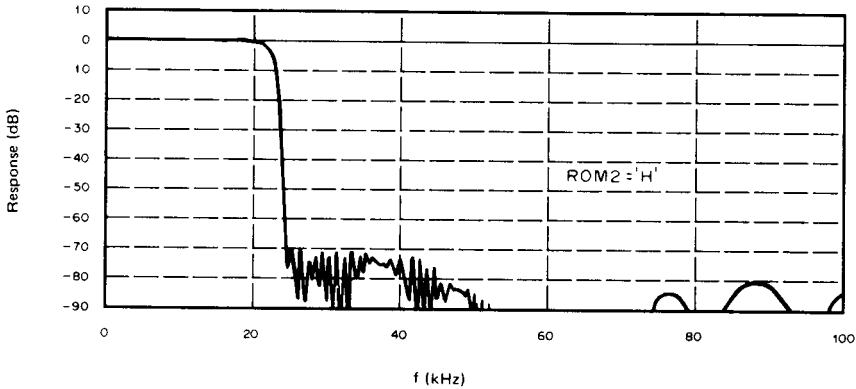



### Filter Characteristics-1

1st Filter+(83 taps ROM1="H")

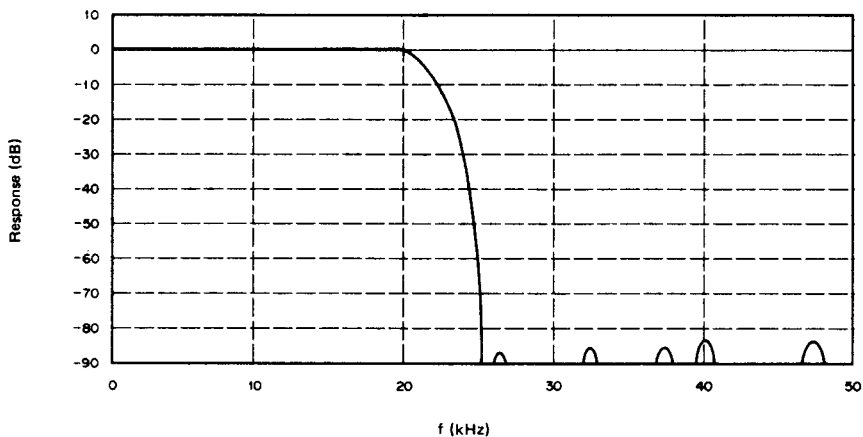

Filter frequency characteristics

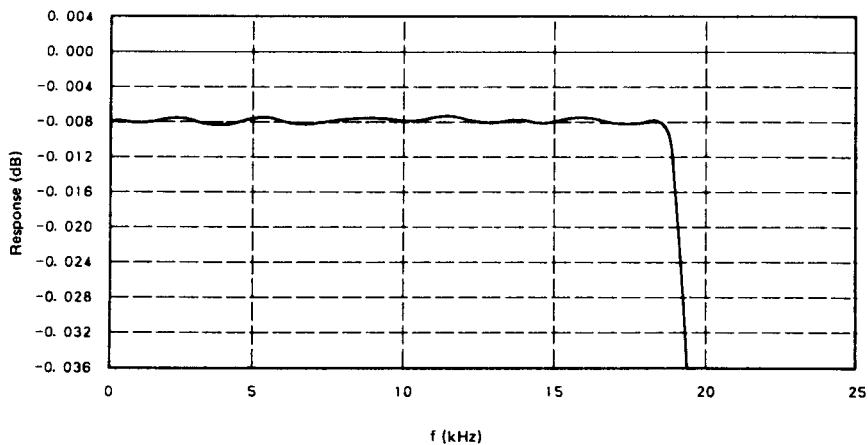

Pass band ripple characteristics

### Filter Characteristics-2

1st Filter (83 taps ROM1="L")

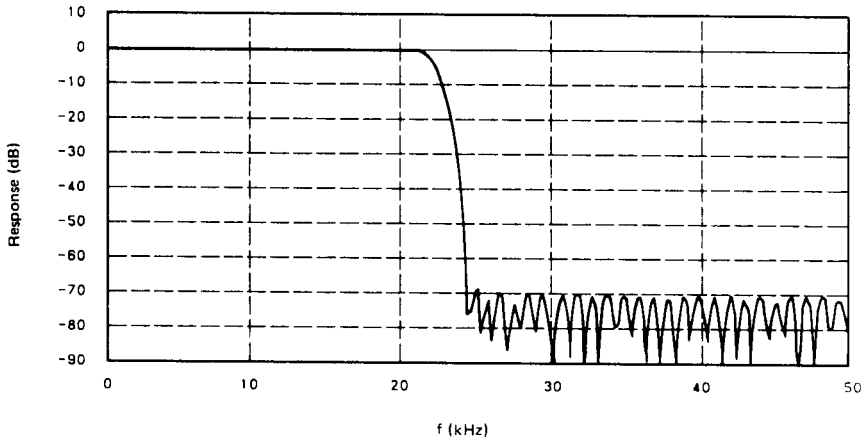

Filter frequency characteristics

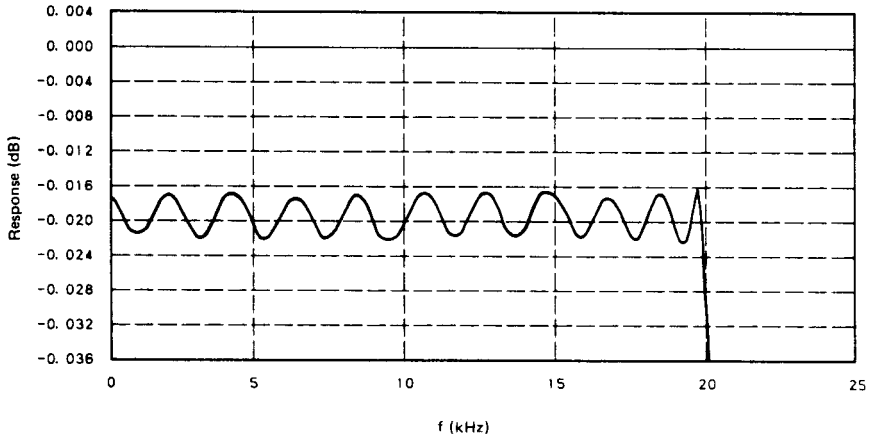

Pass band ripple characteristics

**Filter Characteristics-3**

2nd filter (21 taps, ROM2="H")

- Pass band flat (without frequency characteristics compensation)

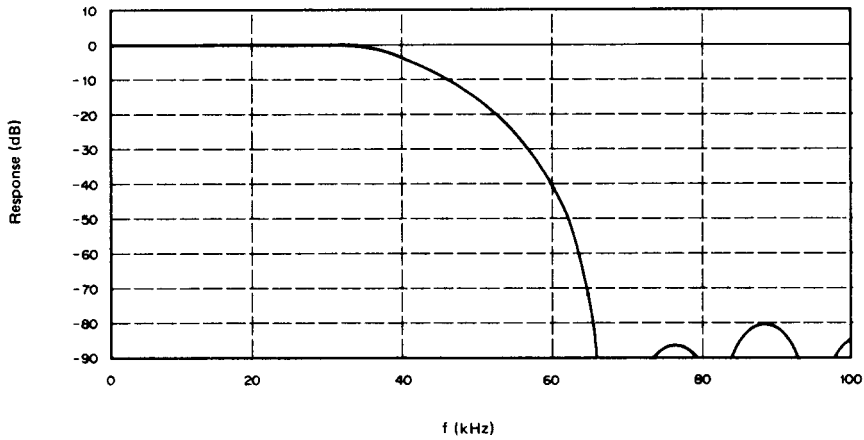

**Filter frequency characteristics**

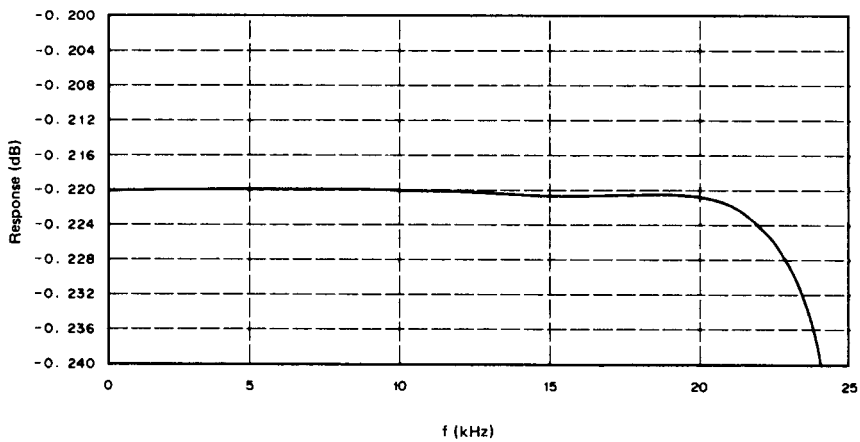

**Pass band ripple characteristics**

### Filter Characteristics-4

2nd filter (21 taps, ROM2="L")

- Pass band frequency characteristics (compensation of aperture effect and analog 3rd order Bessel filter characteristics)

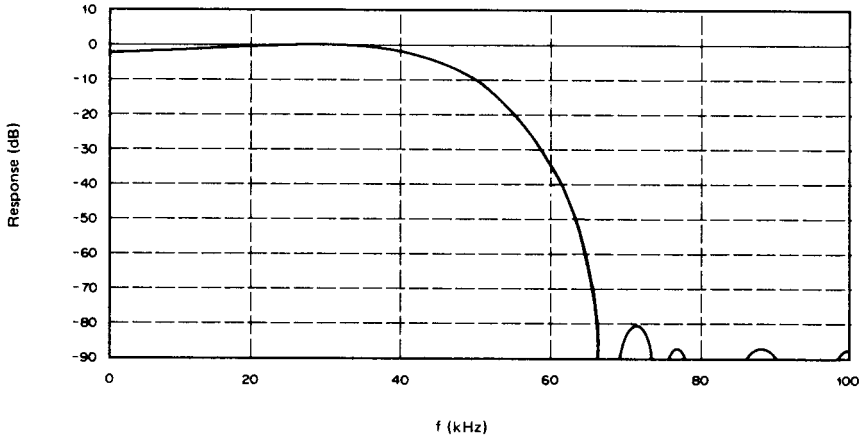

Filter frequency characteristics

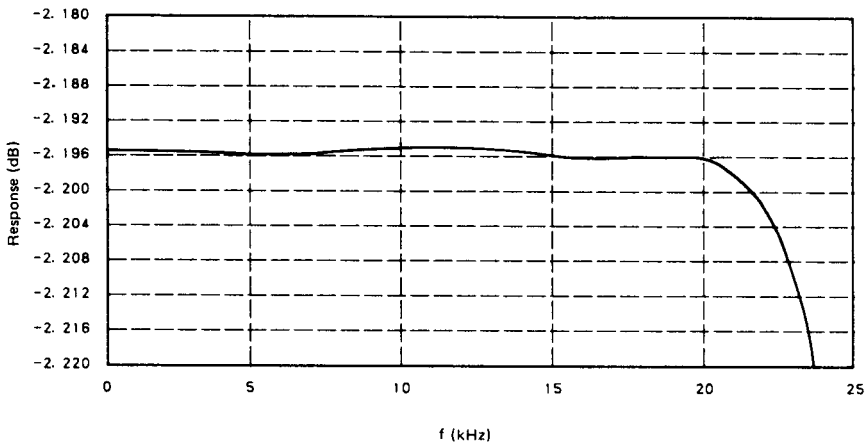

Pass band ripple characteristics

(Excluding frequency characteristics compensation)

T-90-20

**Sony Package Product Name**

Type	Package name		Package	Features				
	Symbol	Description		Material*	Lead pitch	Lead shape	Lead pull out direction	
Inserted	Standard	DIP	DUAL IN LINE PACKAGE		P C	2.54mm (100MIL)	Through Hole Lead	2-direction
		SIP	SINGLE IN LINE PACKAGE		P	2.54mm (100MIL)	Through Hole Lead	1-direction
		ZIP	ZIG ZAG IN LINE PACKAGE		P	2.54mm (100MIL) Zig Zag inline	Through Hole Lead	1-direction
		PGA	PIN GRID ARRAY		C	2.54mm (100MIL)	Through Hole Lead	4-direction
		PIGGY BACK	PIGGY BACK		C	2.54mm (100MIL)	Through Hole Lead	2-direction
Shrink	SDIP	SHRINK DUAL IN LINE PACKAGE		P	1.778mm (70MIL)	Through Hole Lead	2-direction	
Surface mounted	Standard flat package	QFP	QUAD FLAT PACKAGE		P	1.0mm 0.8mm	Gull-Wing	4-direction
		SOP	SMALL-OUTLINE PACKAGE		P	1.27mm (50MIL)	Gull-Wing	2-direction
	Shrink flat package	VQFP	VERY SMALL QUAD FLAT PACKAGE		P	0.5mm	Gull-Wing	4-direction
		VSOP	VERY SMALL OUTLINE PACKAGE		P	0.65mm	Gull Wing	2-direction
	Standard chip carrier	PLCC	PLASTIC LEADED CHIP CARRIER		P	1.27mm (50MIL)	J-bend	4-direction
		LCC	LEAD LESS CHIP CARRIER		C	1.27mm (50MIL)	Lead less	Package side
	Shrink chip carrier	SPLCC (PLCC)	SHRINK PLASTIC LEADED CHIP CARRIER		P	1.27mm Max. (50MIL Max.)	J-bend	4-direction
	Standard 2-direction chip carrier	SOJ	SMALL OUTLINE J-LEAD PACKAGE		P	1.27mm (50MIL)	J-bend	2-direction



\*P.....Plastic, C.....Ceramic