

SONY

CXK5814P

2048-word × 8 bit High Speed CMOS Static RAM

Description

The CXK5814P is a 16,384 bits high speed CMOS static RAM organized as 2,048 words × 8 bits and operates from a single 5V supply.

The CXK5814P is suitable for use in high speed and low power applications in which battery back up for nonvolatility is required.

Features

- Fast access time: 35 ns/45 ns/55 ns (Max.)
- Low power standby: 5 μW (Typ.)—L-version
100 μW (Typ.)—Standard version
- Low power operation: 300 mW (Typ.)
- Single +5V supply
- Fully static memory No clock or timing strobe required
- Equal access and cycle time
- Common data input and output: three-state output
- Directly TTL compatible: All inputs and outputs
- Low voltage data retention: 2.0V (Min.)
- High density: 300 mil 24 pin plastic package

Function

2048-word × 8 bit static RAM

Structure

Silicon Gate CMOS IC

Block Diagram

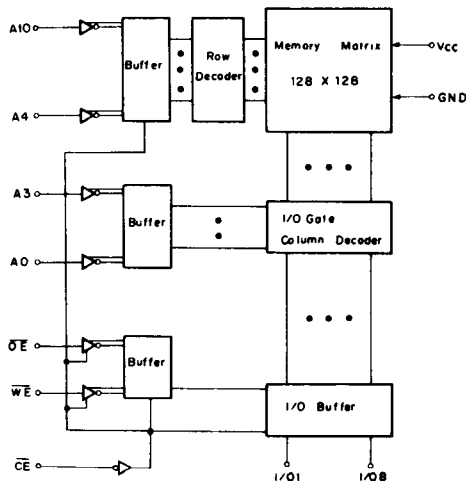

Package Outline

Unit: mm

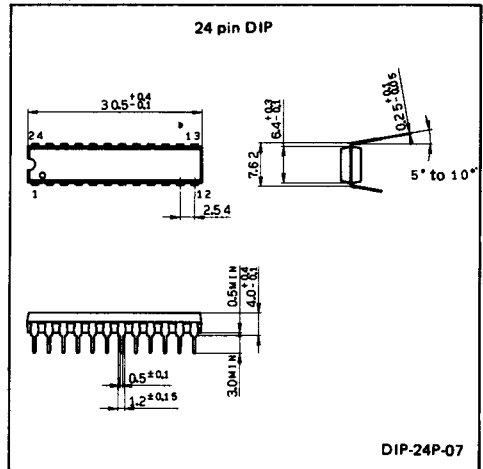

Pin Configuration (Top View)

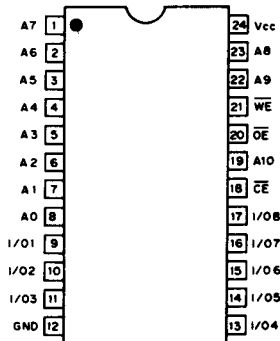

Symbol	Description
A0 to A10	Address Input
I/O1 to I/O8	Data Input Output
\overline{CE}	Chip Enable Input
WE	Write Enable Input
\overline{OE}	Output Enable Input
Vcc	Power Supply
GND	Ground

Absolute Maximum Ratings

(Ta=25°C, GND=0V)

Item	Symbol	Rating	Unit
Power Supply Voltage	V _{CC}	-0.5* to +7.0	V
Input Voltage	V _{IN}	-0.5* to V _{CC} +0.5	V
Input and Output Voltage	V _{I/O}	-0.5* to V _{CC} +0.5	V
Allowable Power Dissipation	P _D	1.0	W
Operating Temperature	T _{OPR}	0 to +70	°C
Storage Temperature	T _{STG}	-55 to +150	°C
Soldering Temperature	T _{SO}	260 ± 10	°C · sec

* V_{CC}, V_{IN}, V_{I/O} min=-3.5V for 20 ns pulse.

Truth Table

\overline{CE}	\overline{OE}	\overline{WE}	Mode	I/O 1 to I/O 8	V _{CC} Current
H	X	X	Not Selected	High Z	I _{SB1} , I _{SB2}
L	H	H	Output Disable	High Z	I _{CC1} , I _{CC2}
L	L	H	Read	D _{OUT}	I _{CC1} , I _{CC2}
L	X	L	Write	D _{IN}	I _{CC1} , I _{CC2}

X: "H" or "L"

DC Recommended Operating Conditions

(Ta=0 to +70°C, GND=0V)

Item	Symbol	Min.	Typ.*	Max.	Unit
Power Supply Voltage	V _{CC}	4.5	5.0	5.5	V
Input High Voltage	V _{IH}	2.2	—	V _{CC} +0.3	V
Input Low Voltage	V _{IL}	-0.3	—	0.8	V

* V_{CC}=5V, Ta=25°C

DC and Operating Characteristics

(V_{CC}=5V±10%, GND=0V, T_a=0 to +70°C)

Item	Symbol	Test condition	CXK5814P -35/45/55			CXK5814P -35L/45L/55L			Unit	
			Min.	Typ.	Max.	Min.	Typ.	Max.		
Input Leakage Current	I _{LI}	V _{IN} =GND to V _{CC}	-2	—	2	-2	—	2	μA	
Output Leakage Current	I _{LO}	$\overline{CE}=V_{IH}$ or $\overline{OE}=V_{IH}$ V _{I/O} =GND to V _{CC}	-2	—	2	-2	—	2	μA	
Operating Power Supply Current	I _{CC1}	$\overline{CE}=V_{IL}$ I _{OUT} =0mA V _{IN} =V _{IH} /V _{IL}	35/35L	—	60	85	—	60	85	mA
		45/45L	—	50	70	—	50	70	mA	
		55/55L	—	40	60	—	40	60	mA	
Average Operating Current	I _{CC2}	Cycle=Min Duty=100% I _{OUT} =0mA	35/35L	—	70	95	—	70	95	mA
		45/45L	—	60	80	—	60	80	mA	
		55/55L	—	50	70	—	50	70	mA	
Standby Current	I _{SB1}	$\overline{CE} \geq V_{CC} - 0.2V$, V _{IN} ≥ V _{CC} - 0.2V or V _{IN} ≤ 0.2V	—	0.02	1.0	—	0.001	0.05	mA	
	I _{SB2}	$\overline{CE}=V_{IH}$, V _{IN} =V _{IH} /V _{IL}	—	15	25	—	15	25	mA	
Output High Voltage	V _{OH}	I _{OH} =-4.0 mA	2.4	—	—	2.4	—	—	V	
Output Low Voltage	V _{OL}	I _{OL} =8.0 mA	—	—	0.4	—	—	0.4	V	

Capacitance

(T_a=25°C, f=1 MHz)

Item	Symbol	Test Condition	Min.	Max.	Unit
Input Capacitance	C _{IN}	V _{IN} =0V	—	5	pF
Input/Output Capacitance	C _{I/O}	V _{I/O} =0V	—	7	pF

Note) This parameter is sampled and is not 100% tested.

AC Operating Characteristics

• AC Test condition

(V_{CC}=5V±10%, T_a=0 to +70°C)

Item	Condition
Input Pulse High Level	V _{IH} =3.0V
Input Pulse Low Level	V _{IL} =0V
Input Rise Time	t _R =5 ns
Input Fall Time	t _F =5 ns
Input and Output Timing Reference Level	1.5V
Output Load	Fig. 1

Output Load (1)

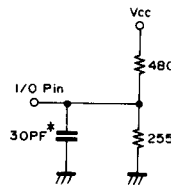

Output Load (2)**

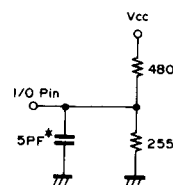

* including scope and jig

** for t_{LZ}, t_{HZ}, t_{OHZ}, t_{OLZ}, t_{OW}, t_{WHZ}

Fig. 1

Read Cycle

Item	Symbol	CXK5814P -35/35L		CXK5814P -45/45L		CXK5814P -55/55L		Unit
		Min.	Max.	Min.	Max.	Min.	Max.	
Read Cycle Time	trc	35	—	45	—	55	—	ns
Address Access Time	tAA	—	35	—	45	—	55	ns
Chip Enable Access Time	tCO	—	35	—	45	—	55	ns
Output Enable to Output Valid	toE	—	20	—	20	—	25	ns
Output Hold from Address Change	toH	5	—	5	—	5	—	ns
Chip Enable to Output in Low Z (\overline{CE})	tlZ*	5	—	5	—	5	—	ns
Output Enable to Output in Low Z (\overline{OE})	tolZ*	0	—	0	—	0	—	ns
Chip Disable to Output in High Z (\overline{CE})	thZ*	0	20	0	20	0	20	ns
Output Disable to Output in High Z (\overline{OE})	toHZ*	0	15	0	15	0	20	ns
Chip Enable to Power Up Time	tpU	0	—	0	—	0	—	ns
Chip Disable to Power Down Time	tpD	—	30	—	30	—	30	ns

Write Cycle

Item	Symbol	CXK5814P -35/35L		CXK5814P -45/45L		CXK5814P -55/55L		Unit
		Min.	Max.	Min.	Max.	Min.	Max.	
Write Cycle Time	tWC	35	—	45	—	55	—	ns
Address Valid to End of Write	tAW	30	—	40	—	50	—	ns
Chip Enable to End of Write	tCW	30	—	40	—	50	—	ns
Data to Write Time Overlap	tdW	15	—	20	—	25	—	ns
Data Hold from Write Time	tdH	0	—	0	—	0	—	ns
Write Pulse Width	tWP	30	—	35	—	40	—	ns
Address Setup Time	tAS	0	—	0	—	0	—	ns
Write Recovery Time	tWR	0	—	0	—	0	—	ns
Output Active from End of Write	tOW*	5	—	5	—	5	—	ns
Write to Output in High Z	tWHZ*	0	20	0	20	0	20	ns

*Note) Transition is measured ± 500 mV from steady state voltage with specified loading in Fig. 1. These parameters are sampled and not 100% tested.

Timing Waveform

(1) Read Cycle [$\overline{WE}=V_{IH}$]

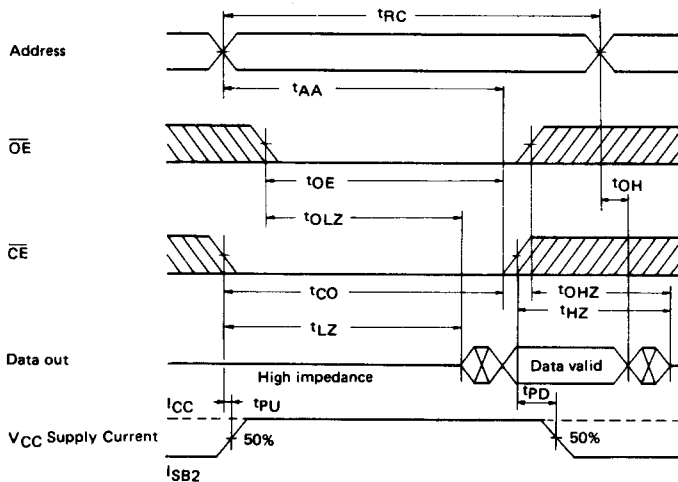

(2) Write Cycle

- Write Cycle No.1: [$\overline{OE}=V_{IL}$ or V_{IH}] (*1)

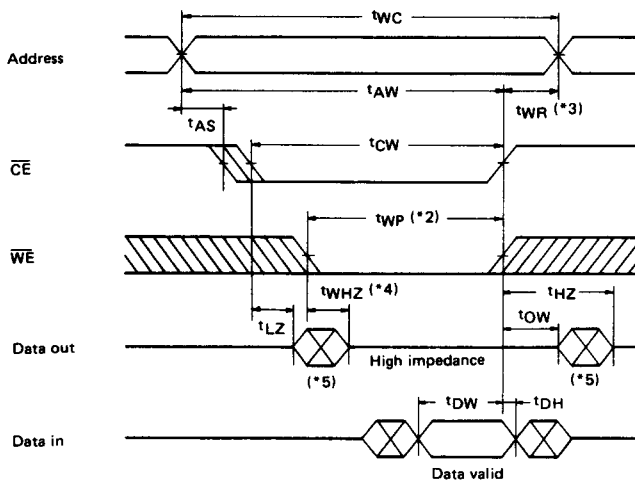

- Write Cycle No.2: [$\overline{OE}=V_{IL}$ or V_{IH} , $\overline{CE}=V_{IL}$] (*1)

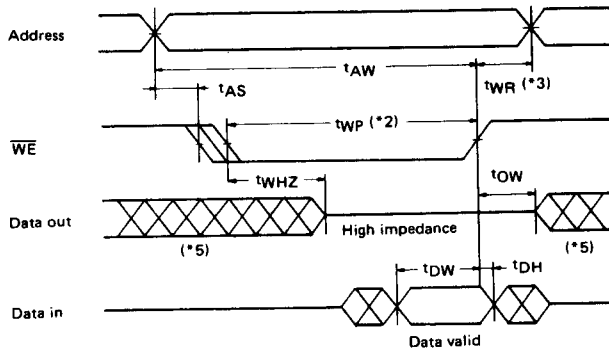

*** Notes)**

1. If \overline{OE} is high, output remains in a high impedance state.
2. A write occurs during the low overlap of \overline{CE} and \overline{WE} .
3. t_{WR} is measured from the earlier of \overline{CE} or \overline{WE} going high to the end of write cycle.
4. If \overline{CE} low transition occurs simultaneously with the \overline{WE} low transition or after the \overline{WE} transition, output remains in a high impedance state.
5. During this period, I/O pins are in the output state so that the input signals of opposite phase to the output must not be applied.

Data Retention Characteristics

($T_a=0$ to $+70^\circ\text{C}$)

Item	Symbol	Test condition	CXK5814P -35/45/55			CXK5814P -35L/45L/55L			Unit
			Min.	Typ.	Max.	Min.	Typ.	Max.	
Data Retention Voltage	V_{DR}	$\overline{CE} \geq V_{CC} - 0.2V$	2.0	5.0	5.5	2.0	5.0	5.5	V
Data Retention Current	I_{CCDR1}	$\overline{CE} \geq V_{CC} - 0.2V, V_{CC} = 3.0V$		12	600		0.6	30	μA
	I_{CCDR2}	$V_{IN} \leq 0.2V$ or $V_{IN} \geq V_{CC} - 0.2V$ $V_{CC} = 2.0$ to $5.5V$		20	1000		1.0	50	μA
Data Retention Set up Time	t_{CDRS}	Chip disable to data retention mode	0			0			ns
Recovery Time	t_R		t_{RC}^*			t_{RC}^*			ns

* t_{RC} : Read Cycle Time

Data Retention Waveform

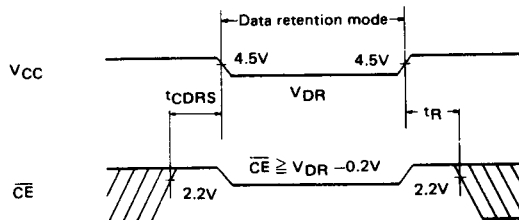

Supply current vs. Supply voltage

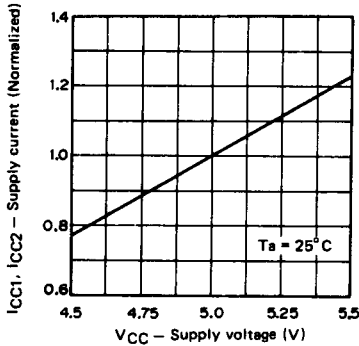

Supply current vs. Ambient temperature

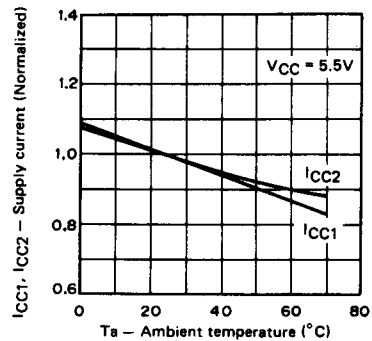

Supply current vs. Frequency

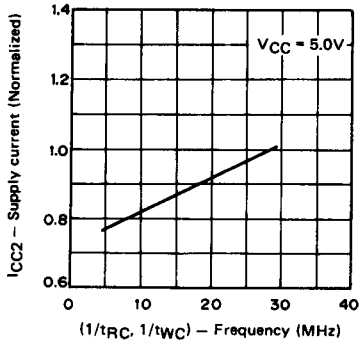

Standby current vs. Ambient temperature

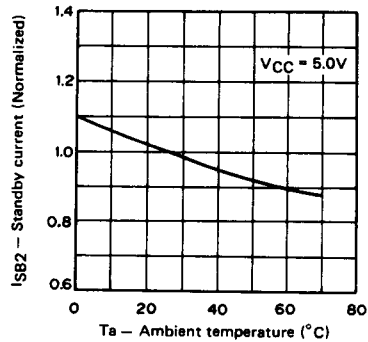

Standby current vs. Supply voltage

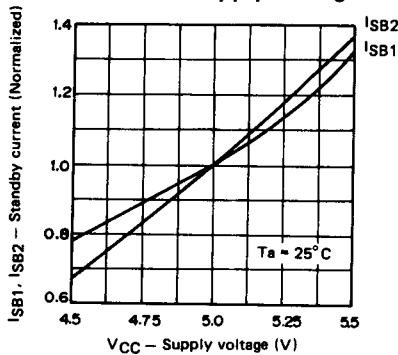

Standby current vs. Ambient temperature

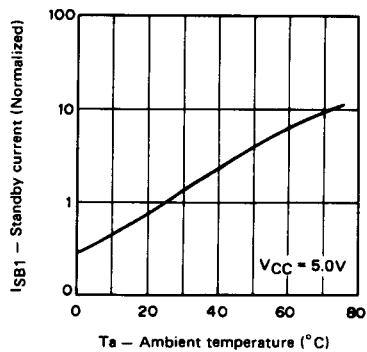

Access time vs. Supply voltage

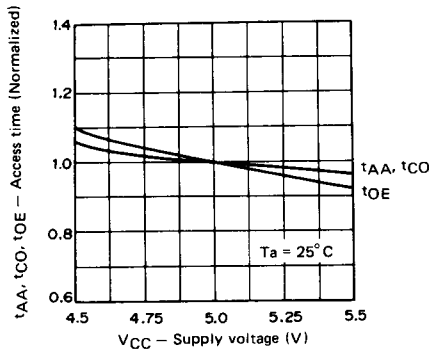

Access time vs. Ambient temperature

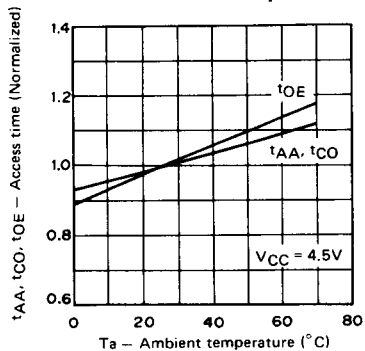

Access time vs. Load capacitance

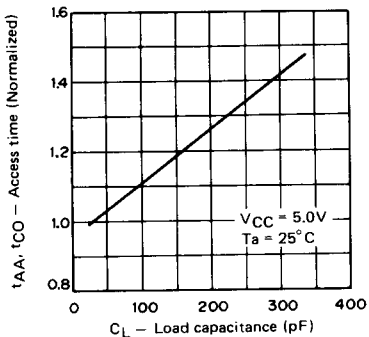

Input voltage vs. Supply voltage

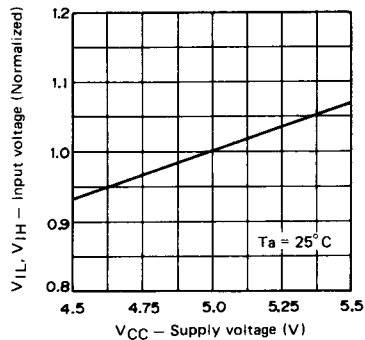

Output current vs. Output voltage

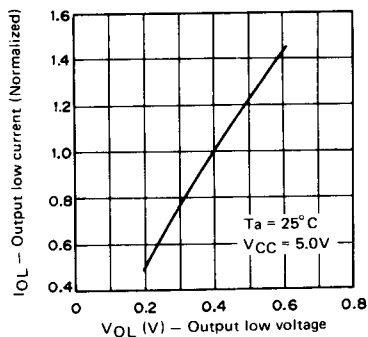

Output current vs. Output voltage

