



# 4-Mbit (256K x 18) Pipelined Sync SRAM

## Features

- Registered inputs and outputs for pipelined operation
- 256K x18 common I/O architecture
- 3.3V core power supply
- 3.3V / 2.5V I/O operation
- Fast clock-to-output times
  - 2.6 ns (for 250-MHz device)
  - 2.6 ns (for 225-MHz device)
  - 2.8 ns (for 200-MHz device)
  - 3.5 ns (for 166-MHz device)
  - 4.0 ns (for 133-MHz device)
  - 4.5 ns (for 100-MHz device)
- Provide high-performance 3-1-1 access rate
- User-selectable burst counter supporting Intel® Pentium® interleaved or linear burst sequences
- Separate processor and controller address strobes
- Synchronous self-timed writes
- Asynchronous output enable
- Lead-Free 100-pin TQFP and 119 Ball BGA packages.
- “ZZ” Sleep Mode Option

## Functional Description<sup>[1]</sup>

The CY7C1327G SRAM integrates 262,144 x 18 SRAM cells with advanced synchronous peripheral circuitry and a two-bit counter for internal burst operation. All synchronous inputs are gated by registers controlled by a positive-edge-triggered Clock Input (CLK). The synchronous inputs include all addresses, all data inputs, address-pipelining Chip Enable ( $\overline{CE}_1$ ), depth-expansion Chip Enables ( $\overline{CE}_2$  and  $\overline{CE}_3$ ), Burst Control inputs ( $\overline{ADSC}$ ,  $\overline{ADSP}$ , and  $\overline{ADV}$ ), Write Enables ( $\overline{BW}_{[A:B]}$  and  $\overline{BWE}$ ), and Global Write ( $\overline{GW}$ ). Asynchronous inputs include the Output Enable ( $\overline{OE}$ ) and the ZZ pin.

Addresses and chip enables are registered at rising edge of clock when either Address Strobe Processor ( $\overline{ADSP}$ ) or Address Strobe Controller ( $\overline{ADSC}$ ) are active. Subsequent burst addresses can be internally generated as controlled by the Advance pin ( $\overline{ADV}$ ).

Address, data inputs, and write controls are registered on-chip to initiate a self-timed Write cycle. This part supports Byte Write operations (see Pin Descriptions and Truth Table for further details). Write cycles can be one to two bytes wide as controlled by the byte write control inputs.  $\overline{GW}$  when active LOW causes all bytes to be written.

The CY7C1327G operates from a +3.3V core power supply while all outputs also operate with a +3.3V or a +2.5V supply. All inputs and outputs are JEDEC-standard JESD8-5-compatible.

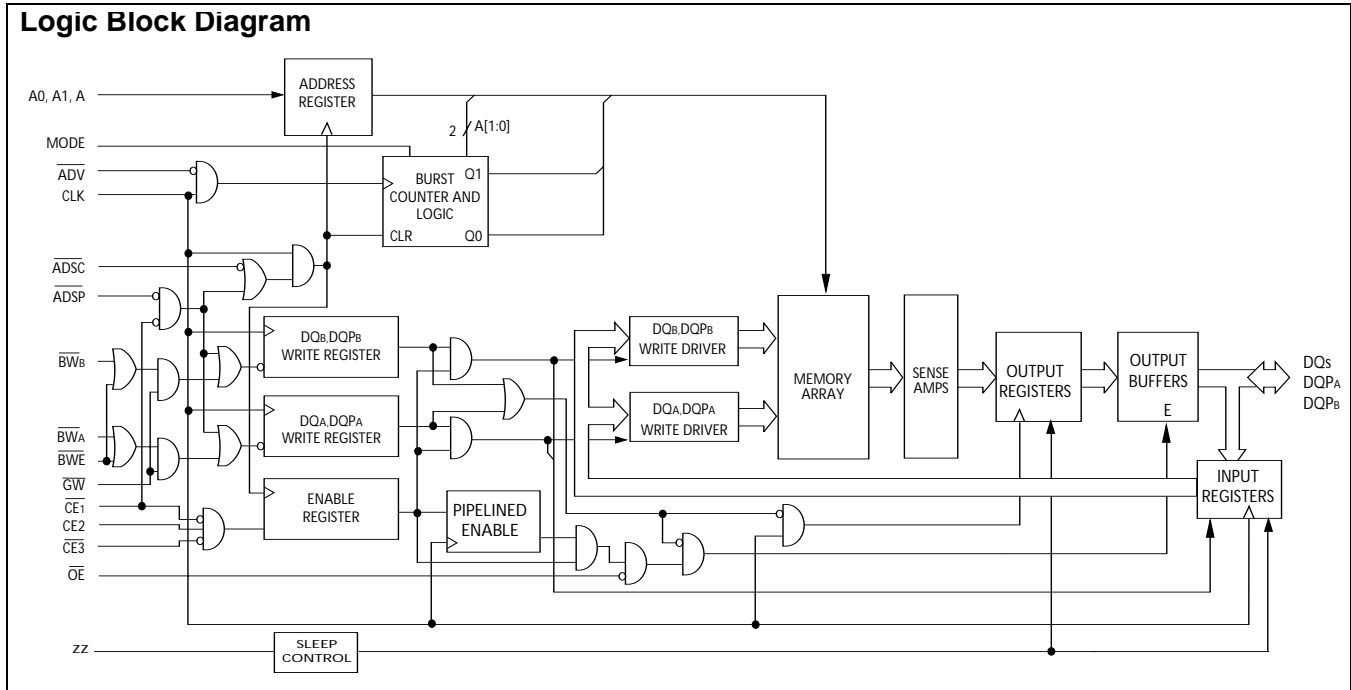

### Note:

1. For best-practices recommendations, please refer to the Cypress application note *System Design Guidelines* on [www.cypress.com](http://www.cypress.com)

**Selection Guide**

	250 MHz	225 MHz	200 MHz	166 MHz	133 MHz	100 MHz	Unit
Maximum Access Time	2.6	2.6	2.8	3.5	4.0	4.5	ns
Maximum Operating Current	325	290	265	240	225	205	mA
Maximum CMOS Standby Current	40	40	40	40	40	40	mA

Shaded areas contain advance information. Please contact your local Cypress sales representative for availability of these parts.

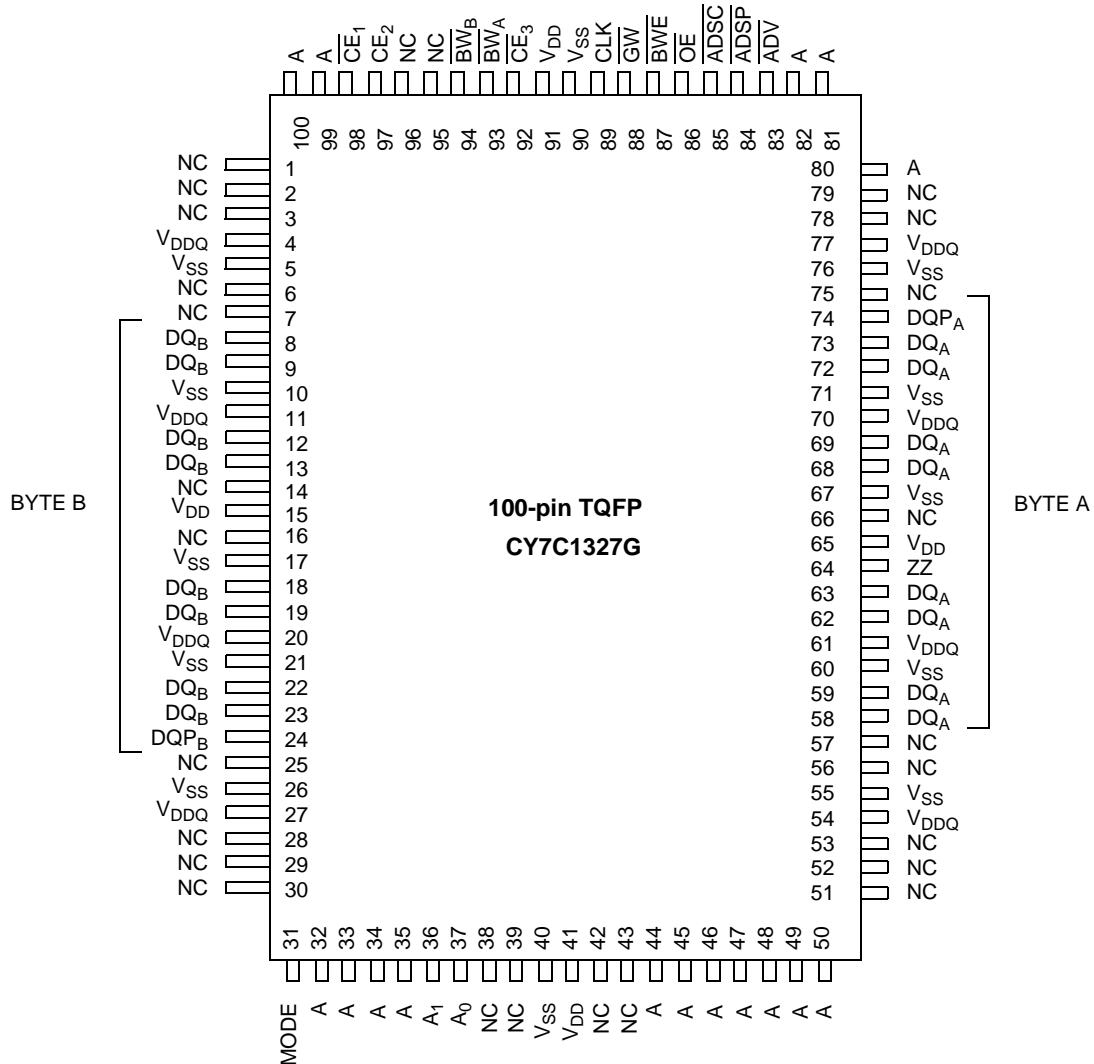
**Pin Configurations**

**Pin Configurations**
**119-ball BGA**

	1	2	3	4	5	6	7
<b>A</b>	V <sub>DDQ</sub>	A	A	$\overline{\text{ADSP}}$	A	A	V <sub>DDQ</sub>
<b>B</b>	NC	CE <sub>2</sub>	A	$\overline{\text{ADSC}}$	A	$\overline{\text{CE}}_3$	NC
<b>C</b>	NC	A	A	V <sub>DD</sub>	A	A	NC
<b>D</b>	DQ <sub>B</sub>	NC	V <sub>SS</sub>	NC	V <sub>SS</sub>	DQP <sub>A</sub>	NC
<b>E</b>	NC	DQ <sub>B</sub>	V <sub>SS</sub>	$\overline{\text{CE}}_1$	V <sub>SS</sub>	NC	DQ <sub>A</sub>
<b>F</b>	V <sub>DDQ</sub>	NC	V <sub>SS</sub>	$\overline{\text{OE}}$	V <sub>SS</sub>	DQ <sub>A</sub>	V <sub>DDQ</sub>
<b>G</b>	NC	DQ <sub>B</sub>	$\overline{\text{BW}}_B$	$\overline{\text{ADV}}$	V <sub>SS</sub>	NC	DQ <sub>A</sub>
<b>H</b>	DQ <sub>B</sub>	NC	V <sub>SS</sub>	$\overline{\text{GW}}$	V <sub>SS</sub>	DQ <sub>A</sub>	NC
<b>J</b>	V <sub>DDQ</sub>	V <sub>DD</sub>	NC	V <sub>DD</sub>	NC	V <sub>DD</sub>	V <sub>DDQ</sub>
<b>K</b>	NC	DQ <sub>B</sub>	V <sub>SS</sub>	CLK	V <sub>SS</sub>	NC	DQ <sub>A</sub>
<b>L</b>	DQ <sub>B</sub>	NC	V <sub>SS</sub>	NC	$\overline{\text{BW}}_A$	DQ <sub>A</sub>	NC
<b>M</b>	V <sub>DDQ</sub>	DQ <sub>B</sub>	V <sub>SS</sub>	$\overline{\text{BWE}}$	V <sub>SS</sub>	NC	V <sub>DDQ</sub>
<b>N</b>	DQ <sub>B</sub>	NC	V <sub>SS</sub>	A1	V <sub>SS</sub>	DQ <sub>A</sub>	NC
<b>P</b>	NC	DQP <sub>B</sub>	V <sub>SS</sub>	A0	V <sub>SS</sub>	NC	DQ <sub>A</sub>
<b>R</b>	NC	A	MODE	V <sub>DD</sub>	NC	A	NC
<b>T</b>	NC	A	A	NC	A	A	ZZ
<b>U</b>	V <sub>DDQ</sub>	NC	NC	NC	NC	NC	V <sub>DDQ</sub>

**Pin Definitions**

Name	I/O	Description
A <sub>0</sub> , A <sub>1</sub> , A	Input-Synchronous	<b>Address Inputs used to select one of the 256K address locations.</b> Sampled at the rising edge of the CLK if ADSP or ADSC is active LOW, and CE <sub>1</sub> , CE <sub>2</sub> , and CE <sub>3</sub> are sampled active. A <sub>1</sub> , A <sub>0</sub> feed the 2-bit counter.
$\overline{BW}_A, \overline{BW}_B$	Input-Synchronous	<b>Byte Write Select Inputs, active LOW.</b> Qualified with BWE to conduct byte writes to the SRAM. Sampled on the rising edge of CLK.
$\overline{GW}$	Input-Synchronous	<b>Global Write Enable Input, active LOW.</b> When asserted LOW on the rising edge of CLK, a global write is conducted (ALL bytes are written, regardless of the values on $\overline{BW}_{[A:B]}$ and BWE).
$\overline{BWE}$	Input-Synchronous	<b>Byte Write Enable Input, active LOW.</b> Sampled on the rising edge of CLK. This signal must be asserted LOW to conduct a byte write.
CLK	Input-Clock	<b>Clock Input.</b> Used to capture all synchronous inputs to the device. Also used to increment the burst counter when ADV is asserted LOW, during a burst operation.
$\overline{CE}_1$	Input-Synchronous	<b>Chip Enable 1 Input, active LOW.</b> Sampled on the rising edge of CLK. Used in conjunction with CE <sub>2</sub> and CE <sub>3</sub> to select/deselect the device. ADSP is ignored if CE <sub>1</sub> is HIGH. CE <sub>1</sub> is sampled only when a new external address is loaded.
CE <sub>2</sub>	Input-Synchronous	<b>Chip Enable 2 Input, active HIGH.</b> Sampled on the rising edge of CLK. Used in conjunction with CE <sub>1</sub> and CE <sub>3</sub> to select/deselect the device. CE <sub>2</sub> is sampled only when a new external address is loaded.
$\overline{CE}_3$	Input-Synchronous	<b>Chip Enable 3 Input, active LOW.</b> Sampled on the rising edge of CLK. Used in conjunction with CE <sub>1</sub> and CE <sub>2</sub> to select/deselect the device. Not connected for BGA. Where referenced, CE <sub>3</sub> is assumed active throughout this document for BGA. CE <sub>3</sub> is sampled only when a new external address is loaded.
$\overline{OE}$	Input-Asynchronous	<b>Output Enable, asynchronous input, active LOW.</b> Controls the direction of the I/O pins. When LOW, the I/O pins behave as outputs. When deasserted HIGH, I/O pins are tri-stated, and act as input data pins. OE is masked during the first clock of a read cycle when emerging from a deselected state.
ADV	Input-Synchronous	<b>Advance Input signal, sampled on the rising edge of CLK, active LOW.</b> When asserted, it automatically increments the address in a burst cycle.
$\overline{ADSP}$	Input-Synchronous	<b>Address Strobe from Processor, sampled on the rising edge of CLK, active LOW.</b> When asserted LOW, A is captured in the address registers. A <sub>1</sub> , A <sub>0</sub> are also loaded into the burst counter. When $\overline{ADSP}$ and $\overline{ADSC}$ are both asserted, only $\overline{ADSP}$ is recognized. $\overline{ADSP}$ is ignored when CE <sub>1</sub> is deasserted HIGH.
ZZ	Input-Asynchronous	<b>ZZ "sleep" Input, active HIGH.</b> This input, when High places the device in a non-time-critical "sleep" condition with data integrity preserved. For normal operation, this pin has to be LOW or left floating. ZZ pin has an internal pull-down.
$\overline{ADSC}$	Input-Synchronous	<b>Address Strobe from Controller, sampled on the rising edge of CLK, active LOW.</b> When asserted LOW, A is captured in the address registers. A <sub>1</sub> , A <sub>0</sub> are also loaded into the burst counter. When $\overline{ADSP}$ and $\overline{ADSC}$ are both asserted, only $\overline{ADSP}$ is recognized.
DQ <sub>A</sub> , DQ <sub>B</sub> , DQP <sub>A</sub> , DQP <sub>B</sub>	I/O-Synchronous	<b>Bidirectional Data I/O lines.</b> As inputs, they feed into an on-chip data register that is triggered by the rising edge of CLK. As outputs, they deliver the data contained in the memory location specified by "A" during the previous clock rise of the read cycle. The direction of the pins is controlled by $\overline{OE}$ . When $\overline{OE}$ is asserted LOW, the pins behave as outputs. When HIGH, DQs and DQP <sub>[A:B]}</sub> are placed in a tri-state condition.
V <sub>DD</sub>	Power Supply	<b>Power supply inputs to the core of the device.</b>
V <sub>SS</sub>	Ground	<b>Ground for the device.</b>
V <sub>DDQ</sub>	I/O Ground	<b>Ground for the I/O circuitry.</b>
MODE	Input-Static	<b>Selects Burst Order.</b> When tied to GND selects linear burst sequence. When tied to V <sub>DD</sub> or left floating selects interleaved burst sequence. This is a strap pin and should remain static during device operation. Mode Pin has an internal pull-up.
NC		<b>No Connects.</b> Not internally connected to the die.

## Functional Overview

All synchronous inputs pass through input registers controlled by the rising edge of the clock. All data outputs pass through output registers controlled by the rising edge of the clock.

The CY7C1327G supports secondary cache in systems utilizing either a linear or interleaved burst sequence. The interleaved burst order supports Pentium and i486™ processors. The linear burst sequence is suited for processors that utilize a linear burst sequence. The burst order is user selectable, and is determined by sampling the MODE input. Accesses can be initiated with either the Processor Address Strobe (ADSP) or the Controller Address Strobe (ADSC). Address advancement through the burst sequence is controlled by the ADV input. A two-bit on-chip wraparound burst counter captures the first address in a burst sequence and automatically increments the address for the rest of the burst access.

Byte Write operations are qualified with the Byte Write Enable (BWE) and Byte Write Select (BW<sub>[A:B]</sub>) inputs. A Global Write Enable (GW) overrides all Byte Write inputs and writes data to all four bytes. All writes are simplified with on-chip synchronous self-timed Write circuitry.

Three synchronous Chip Selects ( $\overline{CE}_1$ ,  $\overline{CE}_2$ ,  $\overline{CE}_3$ ) and an asynchronous Output Enable ( $\overline{OE}$ ) provide for easy bank selection and output tri-state control. ADSP is ignored if  $\overline{CE}_1$  is HIGH.

### Single Read Accesses

This access is initiated when the following conditions are satisfied at clock rise: (1) ADSP or ADSC is asserted LOW, (2)  $\overline{CE}_1$ ,  $\overline{CE}_2$ ,  $\overline{CE}_3$  are all asserted active, and (3) the Write signals (GW, BWE) are all deserted HIGH. ADSP is ignored if  $\overline{CE}_1$  is HIGH. The address presented to the address inputs (A) is stored into the address advancement logic and the Address Register while being presented to the memory array. The corresponding data is allowed to propagate to the input of the Output Registers. At the rising edge of the next clock the data is allowed to propagate through the output register and onto the data bus within t<sub>co</sub> if  $\overline{OE}$  is active LOW. The only exception occurs when the SRAM is emerging from a deselected state to a selected state, its outputs are always tri-stated during the first cycle of the access. After the first cycle of the access, the outputs are controlled by the  $\overline{OE}$  signal. Consecutive single Read cycles are supported. Once the SRAM is deselected at clock rise by the chip select and either ADSP or ADSC signals, its output will tri-state immediately.

#### Single Write Accesses Initiated by ADSP

This access is initiated when both of the following conditions are satisfied at clock rise: (1) ADSP is asserted LOW, and (2)  $\overline{CE}_1$ ,  $\overline{CE}_2$ ,  $\overline{CE}_3$  are all asserted active. The address presented to A is loaded into the address register and the address advancement logic while being delivered to the memory array. The Write signals (GW, BWE, and BW<sub>[A:B]</sub>) and ADV inputs are ignored during this first cycle.

ADSP-triggered Write accesses require two clock cycles to complete. If GW is asserted LOW on the second clock rise, the data presented to the DQ inputs is written into the corresponding address location in the memory array. If GW is HIGH,

then the Write operation is controlled by  $\overline{BWE}$  and  $\overline{BW}_{[A:B]}$  signals. The CY7C1327G provides Byte Write capability that is described in the Write Cycle Descriptions table. Asserting the Byte Write Enable input (BWE) with the selected Byte Write (BW<sub>[A:B]</sub>) input, will selectively write to only the desired bytes. Bytes not selected during a Byte Write operation will remain unaltered. A synchronous self-timed Write mechanism has been provided to simplify the Write operations.

Because the CY7C1327G is a common I/O device, the Output Enable ( $\overline{OE}$ ) must be deserted HIGH before presenting data to the DQ inputs. Doing so will tri-state the output drivers. As a safety precaution, DQs are automatically tri-stated whenever a Write cycle is detected, regardless of the state of  $\overline{OE}$ .

### Single Write Accesses Initiated by ADSC

ADSC Write accesses are initiated when the following conditions are satisfied: (1) ADSC is asserted LOW, (2) ADSP is deserted HIGH, (3)  $\overline{CE}_1$ ,  $\overline{CE}_2$ ,  $\overline{CE}_3$  are all asserted active, and (4) the appropriate combination of the Write inputs (GW, BWE, and BW<sub>[A:B]</sub>) are asserted active to conduct a Write to the desired byte(s). ADSC-triggered Write accesses require a single clock cycle to complete. The address presented to A is loaded into the address register and the address advancement logic while being delivered to the memory array. The ADV input is ignored during this cycle. If a global Write is conducted, the data presented to DQ is written into the corresponding address location in the memory core. If a Byte Write is conducted, only the selected bytes are written. Bytes not selected during a Byte Write operation will remain unaltered. A synchronous self-timed Write mechanism has been provided to simplify the Write operations.

Because the CY7C1327G is a common I/O device, the Output Enable ( $\overline{OE}$ ) must be deserted HIGH before presenting data to the DQ inputs. Doing so will tri-state the output drivers. As a safety precaution, DQs are automatically tri-stated whenever a Write cycle is detected, regardless of the state of  $\overline{OE}$ .

### Burst Sequences

The CY7C1327G provides a two-bit wraparound counter, fed by A1, A0, that implements either an interleaved or linear burst sequence. The interleaved burst sequence is designed specifically to support Intel Pentium applications. The linear burst sequence is designed to support processors that follow a linear burst sequence. The burst sequence is user selectable through the MODE input.

Asserting ADV LOW at clock rise will automatically increment the burst counter to the next address in the burst sequence. Both Read and Write burst operations are supported.

### Sleep Mode

The ZZ input pin is an asynchronous input. Asserting ZZ places the SRAM in a power conservation "sleep" mode. Two clock cycles are required to enter into or exit from this "sleep" mode. While in this mode, data integrity is guaranteed. Accesses pending when entering the "sleep" mode are not considered valid nor is the completion of the operation guaranteed. The device must be deselected prior to entering the "sleep" mode.  $\overline{CE}_1$ ,  $\overline{CE}_2$ ,  $\overline{CE}_3$ , ADSP, and ADSC must remain inactive for the duration of t<sub>ZZREC</sub> after the ZZ input returns LOW.

**Interleaved Burst Address Table (MODE = Floating or V<sub>DD</sub>)**

First Address A1, A0	Second Address A1, A0	Third Address A1, A0	Fourth Address A1, A0
00	01	10	11
01	00	11	10
10	11	00	01
11	10	01	00

**Linear Burst Address Table (MODE = GND)**

First Address A1, A0	Second Address A1, A0	Third Address A1, A0	Fourth Address A1, A0
00	01	10	11
01	10	11	00
10	11	00	01
11	00	01	10

**ZZ Mode Electrical Characteristics**

Parameter	Description	Test Conditions	Min.	Max.	Unit
I <sub>DDZZ</sub>	Snooze mode standby current	ZZ ≥ V <sub>DD</sub> - 0.2V		40	mA
t <sub>ZZS</sub>	Device operation to ZZ	ZZ ≥ V <sub>DD</sub> - 0.2V		2t <sub>CYC</sub>	ns
t <sub>ZZREC</sub>	ZZ recovery time	ZZ ≤ 0.2V	2t <sub>CYC</sub>		ns
t <sub>ZZI</sub>	ZZ active to snooze current	This parameter is sampled		2t <sub>CYC</sub>	ns
t <sub>RZZI</sub>	ZZ Inactive to exit snooze current	This parameter is sampled	0		ns

**Truth Table**<sup>[2, 3, 4, 5, 6]</sup>

Next Cycle	Add. Used	$\overline{CE}_1$	$CE_2$	$\overline{CE}_3$	ZZ	$\overline{ADSP}$	$\overline{ADSC}$	$\overline{ADV}$	$\overline{OE}$	DQ	$\overline{WRITE}$
Unselected	None	H	X	X	L	X	L	X	X	tri-state	X
Unselected	None	L	X	H	L	L	X	X	X	tri-state	X
Unselected	None	L	L	X	L	L	X	X	X	tri-state	X
Unselected	None	L	X	H	L	H	L	X	X	tri-state	X
Unselected	None	L	L	X	L	H	L	X	X	tri-state	X
Begin Read	External	L	H	L	L	L	X	X	X	tri-state	X
Begin Read	External	L	H	L	L	H	L	X	X	tri-state	H
Continue Read	Next	X	X	X	L	H	H	L	H	tri-state	H
Continue Read	Next	X	X	X	L	H	H	L	L	DQ	H
Continue Read	Next	H	X	X	L	X	H	L	H	tri-state	H
Continue Read	Next	H	X	X	L	X	H	L	L	DQ	H
Suspend Read	Current	X	X	X	L	H	H	H	H	tri-state	H
Suspend Read	Current	X	X	X	L	H	H	H	L	DQ	H
Suspend Read	Current	H	X	X	L	X	H	H	H	tri-state	H
Suspend Read	Current	H	X	X	L	X	H	H	L	DQ	H
Begin Write	Current	X	X	X	L	H	H	H	X	tri-state	L
Begin Write	Current	H	X	X	L	X	H	H	X	tri-state	L
Begin Write	External	L	H	L	L	H	H	X	X	tri-state	L
Continue Write	Next	X	X	X	L	H	H	H	X	tri-state	L
Continue Write	Next	H	X	X	L	X	H	H	X	tri-state	L
Suspend Write	Current	X	X	X	L	H	H	H	X	tri-state	L
Suspend Write	Current	H	X	X	L	X	H	H	X	tri-state	L
ZZ "Sleep"	None	X	X	X	H	X	X	X	X	tri-state	X

**Truth Table for Read/Write**<sup>[2]</sup>

Function	$\overline{GW}$	$\overline{BWE}$	$\overline{BW}_B$	$\overline{BW}_A$
Read	H	H	X	X
Read	H	L	H	H
Write Byte A – (DQ <sub>A</sub> and DQP <sub>A</sub> )	H	L	H	L
Write Byte B – (DQ <sub>B</sub> and DQP <sub>B</sub> )	H	L	L	H
Write Bytes B, A	H	L	L	L
Write All Bytes	H	L	L	L
Write All Bytes	L	X	X	X

**Notes:**

- X = "Don't Care." H = Logic HIGH, L = Logic LOW.
- $\overline{WRITE} = L$  when any one or more Byte Write enable signals ( $\overline{BW}_A$ ,  $\overline{BW}_B$ ) and  $\overline{BWE} = L$  or  $\overline{GW} = L$ .  $\overline{WRITE} = H$  when all Byte write enable signals ( $\overline{BW}_A$ ,  $\overline{BW}_B$ ),  $\overline{BWE}$ ,  $\overline{GW} = H$ .
- The DQ pins are controlled by the current cycle and the  $\overline{OE}$  signal.  $\overline{OE}$  is asynchronous and is not sampled with the clock.
- The SRAM always initiates a read cycle when  $\overline{ADSP}$  is asserted, regardless of the state of  $\overline{GW}$ ,  $\overline{BWE}$ , or  $\overline{BW}_{[A, B]}$ . Writes may occur only on subsequent clocks after the  $\overline{ADSP}$  or with the assertion of  $\overline{ADSC}$ . As a result,  $\overline{OE}$  must be driven HIGH prior to the start of the write cycle to allow the outputs to tri-state.  $\overline{OE}$  is a don't care for the remainder of the write cycle.
- $\overline{OE}$  is asynchronous and is not sampled with the clock rise. It is masked internally during write cycles. During a read cycle all data bits are tri-state when  $\overline{OE}$  is inactive or when the device is deselected, and all data bits behave as output when  $\overline{OE}$  is active (LOW).

**Maximum Ratings**

(Above which the useful life may be impaired. For user guidelines, not tested.)

Storage Temperature ..... -65°C to +150°C  
 Ambient Temperature with Power Applied..... -55°C to +125°C  
 Supply Voltage on V<sub>DD</sub> Relative to GND..... -0.5V to +4.6V  
 DC Voltage Applied to Outputs in tri-state ..... -0.5V to V<sub>DDQ</sub> + 0.5V  
 DC Input Voltage..... -0.5V to V<sub>DD</sub> + 0.5V

Current into Outputs (LOW)..... 20 mA  
 Static Discharge Voltage..... > 2001V (per MIL-STD-883, Method 3015)  
 Latch-up Current..... > 200 mA

**Operating Range**

Range	Ambient Temperature	V <sub>DD</sub>	V <sub>DDQ</sub>
Commercial	0°C to +70°C	3.3V -5%/+10%	2.5V -5% to V <sub>DD</sub>
Industrial	-40°C to +85°C		

**Electrical Characteristics** Over the Operating Range [7, 8]

Parameter	Description	Test Conditions	Min.	Max.	Unit
V <sub>DD</sub>	Power Supply Voltage		3.135	3.6	V
V <sub>DDQ</sub>	I/O Supply Voltage		2.375	V <sub>DD</sub>	V
V <sub>OH</sub>	Output HIGH Voltage	V <sub>DDQ</sub> = 3.3V, V <sub>DD</sub> = Min., I <sub>OH</sub> = -4.0 mA	2.4		V
		V <sub>DDQ</sub> = 2.5V, V <sub>DD</sub> = Min., I <sub>OH</sub> = -1.0 mA	2.0		V
V <sub>OL</sub>	Output LOW Voltage	V <sub>DDQ</sub> = 3.3V, V <sub>DD</sub> = Min., I <sub>OL</sub> = 8.0 mA		0.4	V
		V <sub>DDQ</sub> = 2.5V, V <sub>DD</sub> = Min., I <sub>OL</sub> = 1.0 mA		0.4	V
V <sub>IH</sub>	Input HIGH Voltage <sup>[7]</sup>	V <sub>DDQ</sub> = 3.3V	2.0	V <sub>DD</sub> + 0.3V	V
		V <sub>DDQ</sub> = 2.5V	1.7	V <sub>DD</sub> + 0.3V	V
V <sub>IL</sub>	Input LOW Voltage <sup>[7]</sup>	V <sub>DDQ</sub> = 3.3V	-0.3	0.8	V
		V <sub>DDQ</sub> = 2.5V	-0.3	0.7	V
I <sub>X</sub>	Input Load Current except ZZ and MODE	GND ≤ V <sub>I</sub> ≤ V <sub>DDQ</sub>	-5	5	μA
		Input Current of MODE	Input = V <sub>SS</sub>	-30	
	Input Current of ZZ	Input = V <sub>DD</sub>		5	μA
		Input = V <sub>SS</sub>	-5		μA
	Input = V <sub>DD</sub>		30	μA	
I <sub>OZ</sub>	Output Leakage Current	GND ≤ V <sub>I</sub> ≤ V <sub>DDQ</sub> , Output Disabled	-5	5	μA
I <sub>DD</sub>	V <sub>DD</sub> Operating Supply Current	V <sub>DD</sub> = Max., I <sub>OUT</sub> = 0 mA, f = f <sub>MAX</sub> = 1/t <sub>CYC</sub>	4-ns cycle, 250MHz	325	mA
			4.4-ns cycle, 225MHz	290	mA
			5-ns cycle, 200MHz	265	mA
			6-ns cycle, 166MHz	240	mA
			7.5-ns cycle, 133MHz	225	mA
			10-ns cycle, 100MHz	205	mA
I <sub>SB1</sub>	Automatic CE Power-down Current—TTL Inputs	V <sub>DD</sub> = Max, Device Deselected, V <sub>IN</sub> ≥ V <sub>IH</sub> or V <sub>IN</sub> ≤ V <sub>IL</sub> , f = f <sub>MAX</sub> = 1/t <sub>CYC</sub>	4-ns cycle, 250MHz	120	mA
			4.4-ns cycle, 225MHz	115	mA
			5-ns cycle, 200MHz	110	mA
			6-ns cycle, 166MHz	100	mA
			7.5-ns cycle, 133MHz	90	mA
			10-ns cycle, 100MHz	80	mA
I <sub>SB2</sub>	Automatic CE Power-down Current—CMOS Inputs	V <sub>DD</sub> = Max, Device Deselected, V <sub>IN</sub> ≤ 0.3V or V <sub>IN</sub> ≥ V <sub>DDQ</sub> - 0.3V, f = 0	All speeds	40	mA

Shaded areas contain advance information.

**Notes:**

7. Overshoot: V<sub>IH</sub>(AC) < V<sub>DD</sub> + 1.5V (Pulse width less than t<sub>CYC</sub>/2), undershoot: V<sub>IL</sub>(AC) > -2V (Pulse width less than t<sub>CYC</sub>/2).
8. T<sub>Power-up</sub>: Assumes a linear ramp from 0v to V<sub>DD</sub>(min.) within 200ms. During this time V<sub>IH</sub> ≤ V<sub>DD</sub> and V<sub>DDQ</sub> ≤ V<sub>DD</sub>.



**Electrical Characteristics** Over the Operating Range (continued)<sup>[7, 8]</sup>

Parameter	Description	Test Conditions	Min.	Max.	Unit	
I <sub>SB3</sub>	Automatic CE Power-down Current—CMOS Inputs	V <sub>DD</sub> = Max, Device Deselected, or V <sub>IN</sub> ≤ 0.3V or V <sub>IN</sub> ≥ V <sub>DDQ</sub> - 0.3V f = f <sub>MAX</sub> = 1/t <sub>CYC</sub>	4-ns cycle, 250MHz		105	mA
			4.4-ns cycle, 225MHz		100	mA
			5-ns cycle, 200MHz		95	mA
			6-ns cycle, 166MHz		85	mA
			7.5-ns cycle, 133MHz		75	mA
			10-ns cycle, 100MHz		65	mA
I <sub>SB4</sub>	Automatic CE Power-down Current—TTL Inputs	V <sub>DD</sub> = Max, Device Deselected, V <sub>IN</sub> ≥ V <sub>IH</sub> or V <sub>IN</sub> ≤ V <sub>IL</sub> , f = 0	All speeds		45	mA

**Thermal Resistance**<sup>[9]</sup>

Parameter	Description	Test Conditions	TQFP Package	BGA Package	Unit
Θ <sub>JA</sub>	Thermal Resistance (Junction to Ambient)	Test conditions follow standard test methods and procedures for measuring thermal impedance, per EIA / JESD51.	TBD	TBD	°C/W
Θ <sub>JC</sub>	Thermal Resistance (Junction to Case)		TBD	TBD	°C/W

**Capacitance**<sup>[9]</sup>

Parameter	Description	Test Conditions	TQFP Package	BGA Package	Unit
C <sub>IN</sub>	Input Capacitance	T <sub>A</sub> = 25°C, f = 1 MHz, V <sub>DD</sub> = 3.3V, V <sub>DDQ</sub> = 3.3V	5	5	pF
C <sub>CLK</sub>	Clock Input Capacitance		5	5	pF
C <sub>I/O</sub>	Input/Output Capacitance		5	7	pF

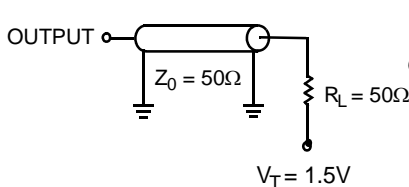
**AC Test Loads and Waveforms**
**3.3V I/O Test Load**

(a)

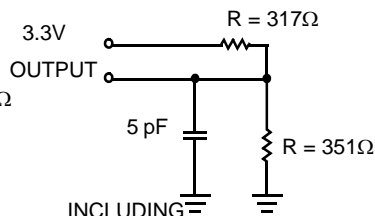

(b)

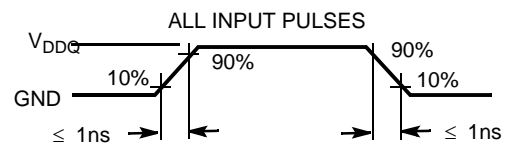
 INCLUDING  
JIG AND  
SCOPE

(c)

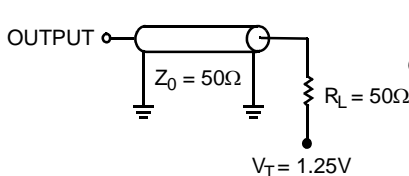
**2.5V I/O Test Load**

(a)

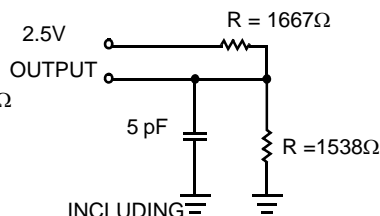

(b)

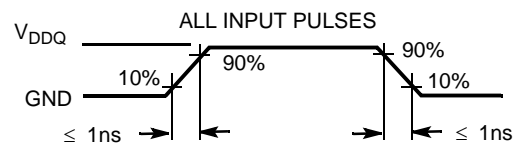
 INCLUDING  
JIG AND  
SCOPE

(c)

**Notes:**

9. Tested initially and after any design or process change that may affect these parameters.

**Switching Characteristics** Over the Operating Range<sup>[14, 15]</sup>

Parameter	Description	250 MHz		225 MHz		200 MHz		166 MHz		133 MHz		100 MHz		Unit
		Min.	Max	Min.	Max	Min.	Max	Min.	Max	Min.	Max	Min.	Max	
t <sub>POWER</sub>	V <sub>DD</sub> (Typical) to the first <sup>[10]</sup>	1		1		1		1		1		1		ms
<b>Clock</b>														
t <sub>CYC</sub>	Clock Cycle Time	4.0		4.4		5.0		6.0		7.5		10		ns
t <sub>CH</sub>	Clock HIGH	1.7		2.0		2.0		2.5		3.0		3.5		ns
t <sub>CL</sub>	Clock LOW	1.7		2.0		2.0		2.5		3.0		3.5		ns
<b>Output Times</b>														
t <sub>CO</sub>	Data Output Valid After CLK Rise		2.6		2.6		2.8		3.5		4.0		4.5	ns
t <sub>DOH</sub>	Data Output Hold After CLK Rise	1.0		1.0		1.0		1.5		1.5		1.5		ns
t <sub>CLZ</sub>	Clock to Low-Z <sup>[11, 12, 13]</sup>	0		0		0		0		0		0		ns
t <sub>CHZ</sub>	Clock to High-Z <sup>[11, 12, 13]</sup>		2.6		2.6		2.8		3.5		4.0		4.5	ns
t <sub>OE<sub>V</sub></sub>	$\overline{OE}$ LOW to Output Valid		2.6		2.6		2.8		3.5		4.5		4.5	ns
t <sub>OE<sub>LZ</sub></sub>	$\overline{OE}$ LOW to Output Low-Z <sup>[11, 12, 13]</sup>	0		0		0		0		0		0		ns
t <sub>OE<sub>HZ</sub></sub>	$\overline{OE}$ HIGH to Output High-Z <sup>[11, 12, 13]</sup>		2.6		2.6		2.8		3.5		4.0		4.5	ns
<b>Set-up Times</b>														
t <sub>AS</sub>	Address Set-up Before CLK Rise	1.2		1.2		1.2		1.5		1.5		1.5		ns
t <sub>ADS</sub>	$\overline{ADSC}$ , $\overline{ADSP}$ Set-up Before CLK Rise	1.2		1.2		1.2		1.5		1.5		1.5		ns
t <sub>ADVS</sub>	$\overline{ADV}$ Set-up Before CLK Rise	1.2		1.2		1.2		1.5		1.5		1.5		ns
t <sub>WES</sub>	$\overline{GW}$ , $\overline{BWE}$ , $\overline{BW}_X$ Set-up Before CLK Rise	1.2		1.2		1.2		1.5		1.5		1.5		ns
t <sub>DS</sub>	Data Input Set-up Before CLK Rise	1.2		1.2		1.2		1.5		1.5		1.5		ns
t <sub>CES</sub>	Chip Enable Set-Up Before CLK Rise	1.2		1.2		1.2		1.5		1.5		1.5		ns
<b>Hold Times</b>														
t <sub>AH</sub>	Address Hold After CLK Rise	0.3		0.5		0.5		0.5		0.5		0.5		ns
t <sub>ADH</sub>	$\overline{ADSP}$ , $\overline{ADSC}$ Hold After CLK Rise	0.3		0.5		0.5		0.5		0.5		0.5		ns
t <sub>ADVH</sub>	$\overline{ADV}$ Hold After CLK Rise	0.3		0.5		0.5		0.5		0.5		0.5		ns
t <sub>WEH</sub>	$\overline{GW}$ , $\overline{BWE}$ , $\overline{BW}_X$ Hold After CLK Rise	0.3		0.5		0.5		0.5		0.5		0.5		ns
t <sub>DH</sub>	Data Input Hold After CLK Rise	0.3		0.5		0.5		0.5		0.5		0.5		ns
t <sub>CEH</sub>	Chip Enable Hold After CLK Rise	0.3		0.5		0.5		0.5		0.5		0.5		ns

Shaded areas contain advance information.

**Notes:**

10. This part has a voltage regulator internally; t<sub>POWER</sub> is the time that the power needs to be supplied above V<sub>DD</sub>(minimum) initially before a read or write operation can be initiated.
11. t<sub>CHZ</sub>, t<sub>CLZ</sub>, t<sub>OELZ</sub>, and t<sub>OE<sub>HZ</sub></sub> are specified with AC test conditions shown in part (b) of AC Test Loads. Transition is measured ± 200 mV from steady-state voltage.
12. At any given voltage and temperature, t<sub>OE<sub>HZ</sub></sub> is less than t<sub>OELZ</sub> and t<sub>CHZ</sub> is less than t<sub>CLZ</sub> to eliminate bus contention between SRAMs when sharing the same data bus. These specifications do not imply a bus contention condition, but reflect parameters guaranteed over worst case user conditions. Device is designed to achieve High-Z prior to Low-Z under the same system conditions.
13. This parameter is sampled and not 100% tested.
14. Timing references level is 1.5V when V<sub>DDQ</sub> = 3.3V and is 1.25V when V<sub>DDQ</sub> = 2.5V on all data sheets.
15. Test conditions shown in (a) of AC Test Loads unless otherwise noted.

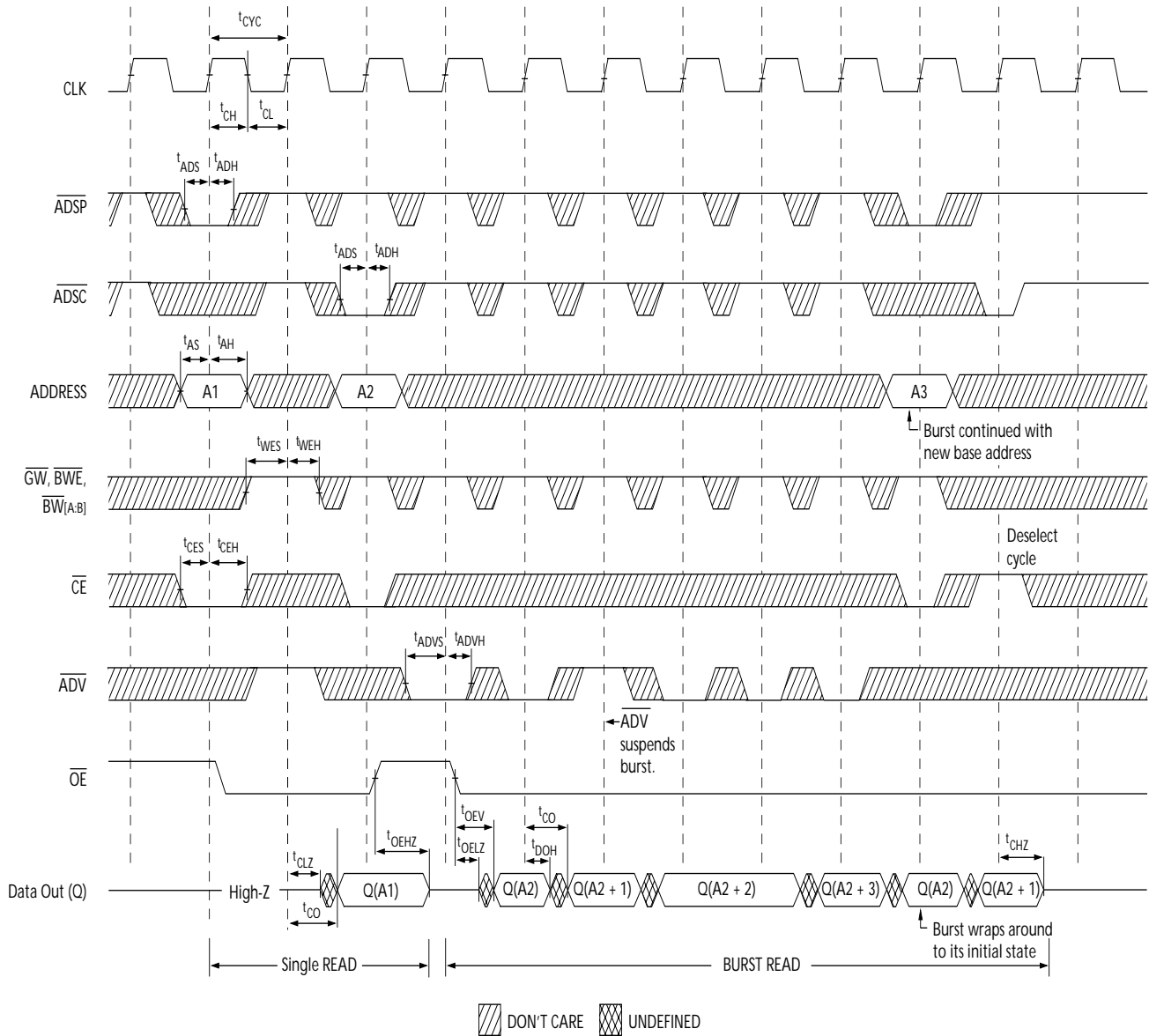
**Switching Waveforms**
**Read Cycle Timing<sup>[16]</sup>**

**Notes:**

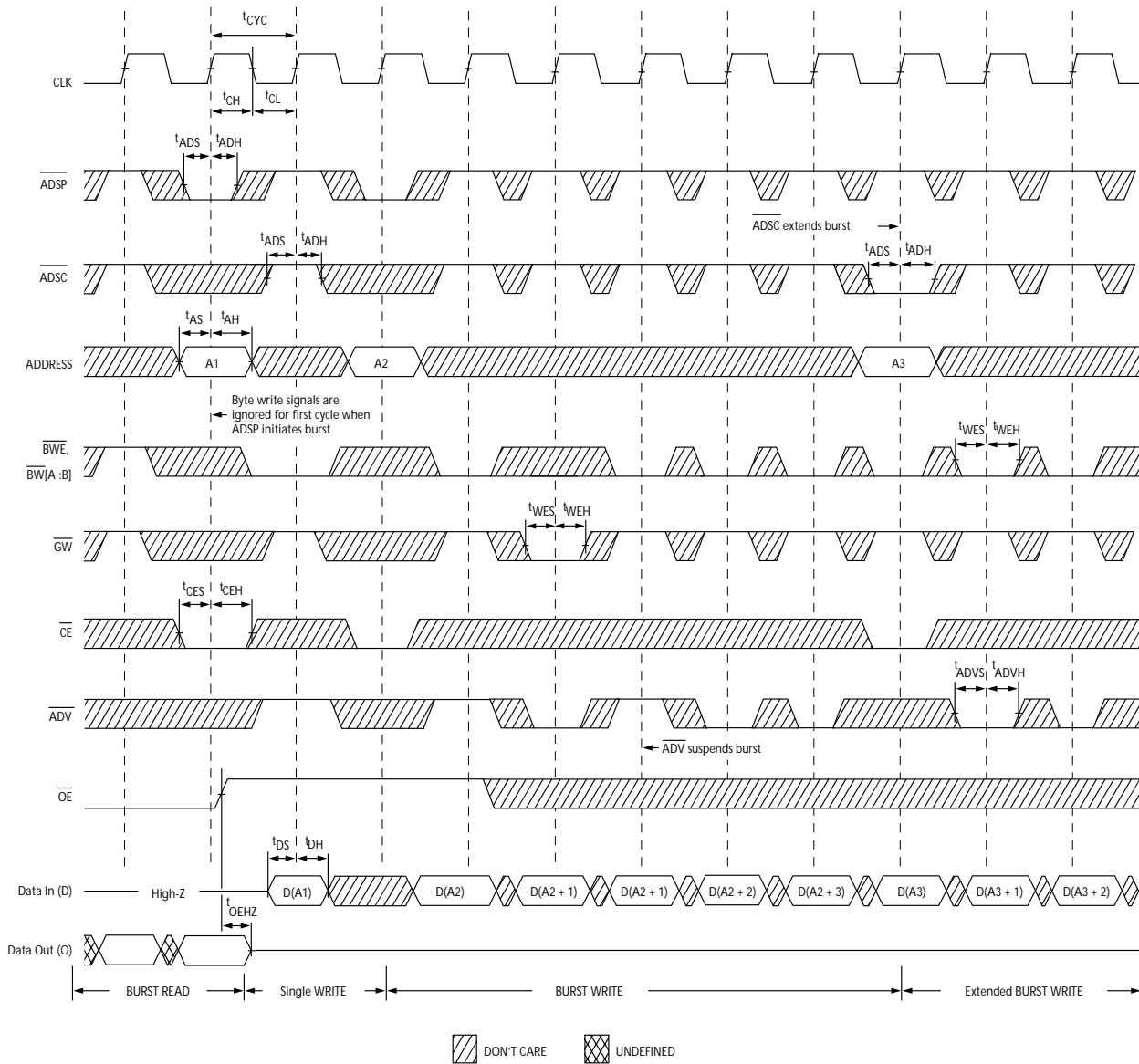
16. On this diagram, when  $\overline{CE}$  is LOW:  $\overline{CE}_1$  is LOW,  $\overline{CE}_2$  is HIGH and  $\overline{CE}_3$  is LOW. When  $\overline{CE}$  is HIGH:  $\overline{CE}_1$  is HIGH or  $\overline{CE}_2$  is LOW or  $\overline{CE}_3$  is HIGH.  
 17. Full width write can be initiated by either GW LOW; or by GW HIGH, BWE LOW and  $BW_{[A:B]}$  LOW.

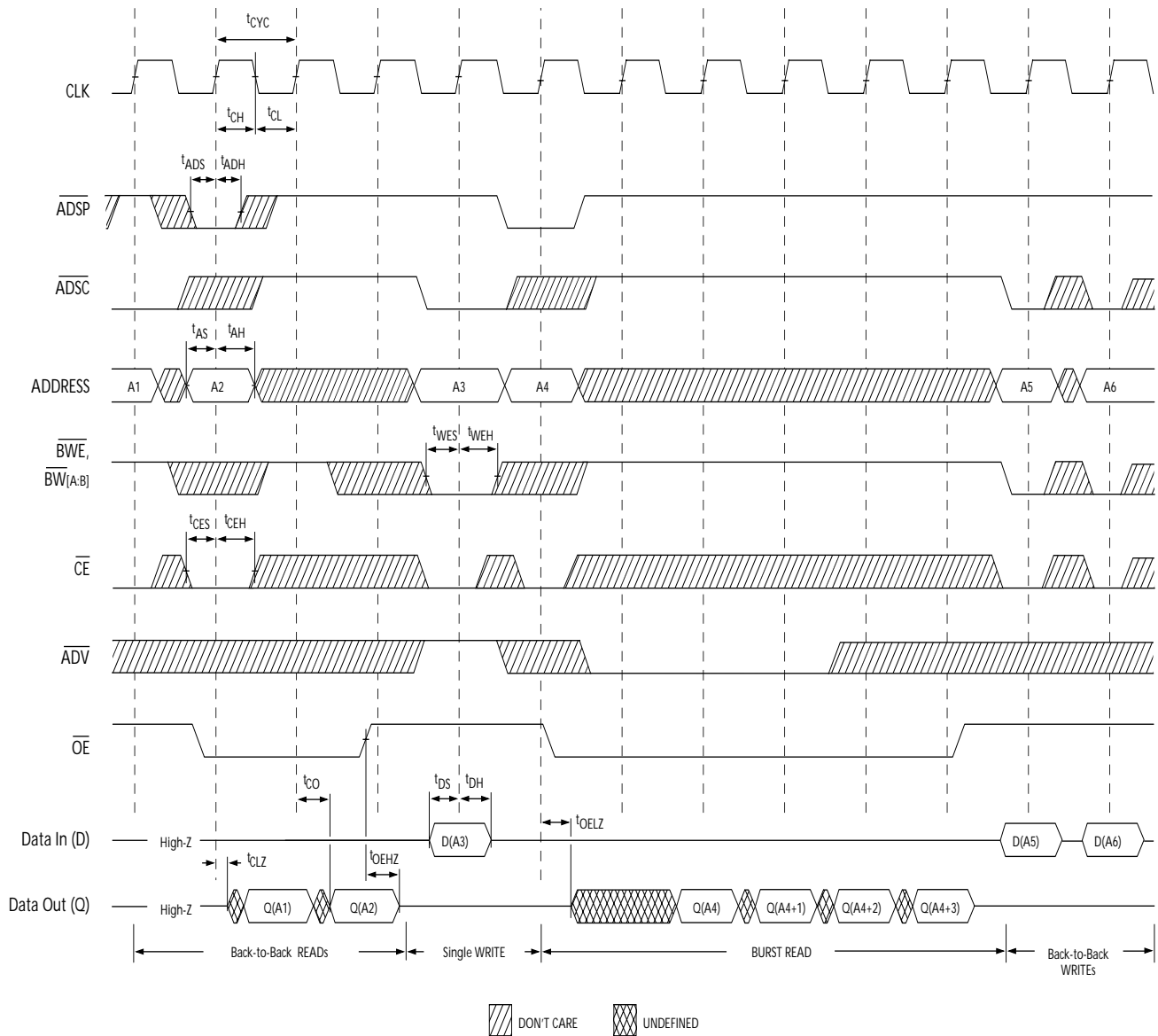
**Switching Waveforms (continued)**
**Write Cycle Timing<sup>[16, 17]</sup>**

**Switching Waveforms (continued)**  
**Read/Write Cycle Timing [16, 18, 19]**

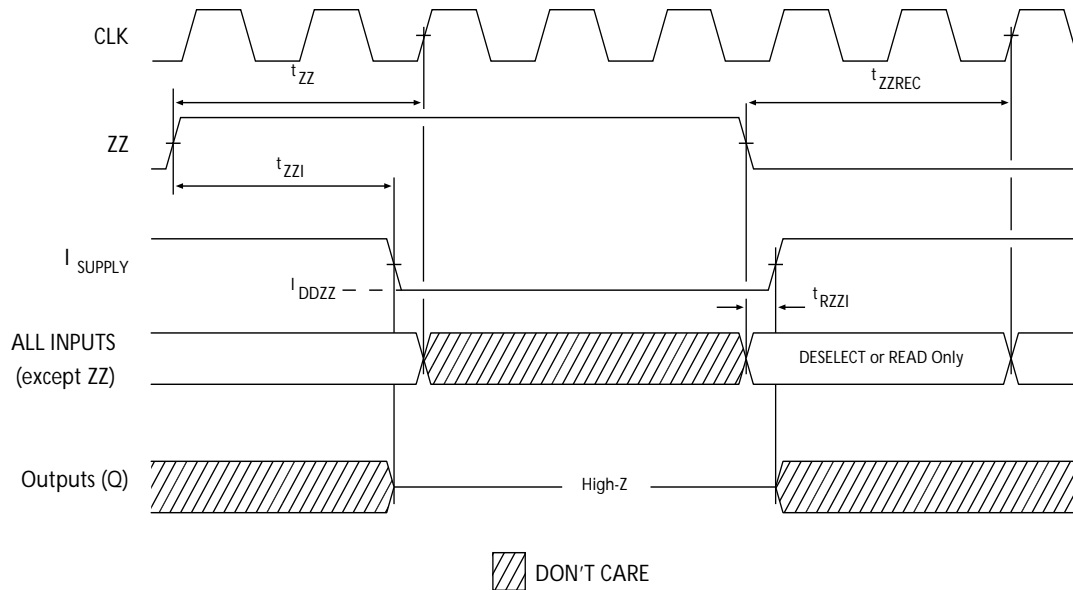
**Notes:**

18. The data bus (Q) remains in high-Z following a WRITE cycle, unless a new read access is initiated by  $\overline{ADSP}$  or  $\overline{ADSC}$ .
19.  $\overline{GW}$  is HIGH.

**Switching Waveforms (continued)**
**ZZ Mode Timing** [20, 21]

**Ordering Information**

Speed (MHz)	Ordering Code	Package Name	Package Type	Operating Range
250	CY7C1327G-250AXC	A101	Lead-Free 100-Lead Thin Quad Flat Pack (14 x 20 x 1.4mm)	Commercial
	CY7C1327G-250BGC	BG119	119-Ball BGA (14 x 22 x 2.4mm)	
	CY7C1327G-250BGXC	BG119	Lead-Free 119-Ball BGA (14 x 22 x 2.4mm)	
	Industrial	CY7C1327G-250AXI	A101	Lead-Free 100-Lead Thin Quad Flat Pack (14 x 20 x 1.4mm)
		CY7C1327G-250BGI	BG119	119-Ball BGA (14 x 22 x 2.4mm)
		CY7C1327G-250BGXI	BG119	Lead-Free 119-Ball BGA (14 x 22 x 2.4mm)
225	CY7C1327G-225AXC	A101	Lead-Free 100-Lead Thin Quad Flat Pack (14 x 20 x 1.4mm)	Commercial
	CY7C1327G-225BGC	BG119	119-Ball BGA (14 x 22 x 2.4mm)	
	CY7C1327G-225BGXC	BG119	Lead-Free 119-Ball BGA (14 x 22 x 2.4mm)	
	Industrial	CY7C1327G-225AXI	A101	Lead-Free 100-Lead Thin Quad Flat Pack (14 x 20 x 1.4mm)
		CY7C1327G-225BGI	BG119	119-Ball BGA (14 x 22 x 2.4mm)
		CY7C1327G-225BGXI	BG119	Lead-Free 119-Ball BGA (14 x 22 x 2.4mm)
200	CY7C1327G-200AXC	A101	Lead-Free 100-Lead Thin Quad Flat Pack (14 x 20 x 1.4mm)	Commercial
	CY7C1327G-200BGC	BG119	119-Ball BGA (14 x 22 x 2.4mm)	
	CY7C1327G-200BGXC	BG119	Lead-Free 119-Ball BGA (14 x 22 x 2.4mm)	
	Industrial	CY7C1327G-200AXI	A101	Lead-Free 100-Lead Thin Quad Flat Pack (14 x 20 x 1.4mm)
		CY7C1327G-200BGI	BG119	119-Ball BGA (14 x 22 x 2.4mm)
		CY7C1327G-200BGXI	BG119	Lead-Free 119-Ball BGA (14 x 22 x 2.4mm)

**Notes:**

20. Device must be deselected when entering ZZ mode. See Cycle Descriptions table for all possible signal conditions to deselect the device.

21. DQs are in high-Z when exiting ZZ sleep mode.

**Ordering Information** (continued)

Speed (MHz)	Ordering Code	Package Name	Package Type	Operating Range
166	CY7C1327G-166AXC	A101	Lead-Free 100-Lead Thin Quad Flat Pack (14 x 20 x 1.4mm)	Commercial
	CY7C1327G-166BGC	BG119	119-Ball BGA (14 x 22 x 2.4mm)	
	CY7C1327G-166BGXC	BG119	Lead-Free 119-Ball BGA (14 x 22 x 2.4mm)	
	CY7C1327G-166AXI	A101	Lead-Free 100-Lead Thin Quad Flat Pack (14 x 20 x 1.4mm)	Industrial
	CY7C1327G-166BGI	BG119	119-Ball BGA (14 x 22 x 2.4mm)	
	CY7C1327G-166BGXI	BG119	Lead-Free 119-Ball BGA (14 x 22 x 2.4mm)	
133	CY7C1327G-133AXC	A101	Lead-Free 100-Lead Thin Quad Flat Pack (14 x 20 x 1.4mm)	Commercial
	CY7C1327G-133BGC	BG119	119-Ball BGA (14 x 22 x 2.4mm)	
	CY7C1327G-133BGXC	BG119	Lead-Free 119-Ball BGA (14 x 22 x 2.4mm)	
	CY7C1327G-133AXI	A101	Lead-Free 100-Lead Thin Quad Flat Pack (14 x 20 x 1.4mm)	Industrial
	CY7C1327G-133BGI	BG119	119-Ball BGA (14 x 22 x 2.4mm)	
	CY7C1327G-133BGXI	BG119	Lead-Free 119-Ball BGA (14 x 22 x 2.4mm)	
100	CY7C1327G-100AXC	A101	Lead-Free 100-Lead Thin Quad Flat Pack (14 x 20 x 1.4mm)	Commercial
	CY7C1327G-100BGC	BG119	119-Ball BGA (14 x 22 x 2.4mm)	
	CY7C1327G-100BGXC	BG119	Lead-Free 119-Ball BGA (14 x 22 x 2.4mm)	
	CY7C1327G-100AXI	A101	Lead-Free 100-Lead Thin Quad Flat Pack (14 x 20 x 1.4mm)	Industrial
	CY7C1327G-100BGI	BG119	119-Ball BGA (14 x 22 x 2.4mm)	
	CY7C1327G-100BGXI	BG119	Lead-Free 119-Ball BGA (14 x 22 x 2.4mm)	

Shaded areas contain advance information. Please contact your local Cypress sales representative for availability of these parts. Lead-Free BG package will be available in 2005

Package Diagrams

100-Pin Thin Plastic Quad Flatpack (14 x 20 x 1.4 mm) A101

DIMENSIONS ARE IN MILLIMETERS.

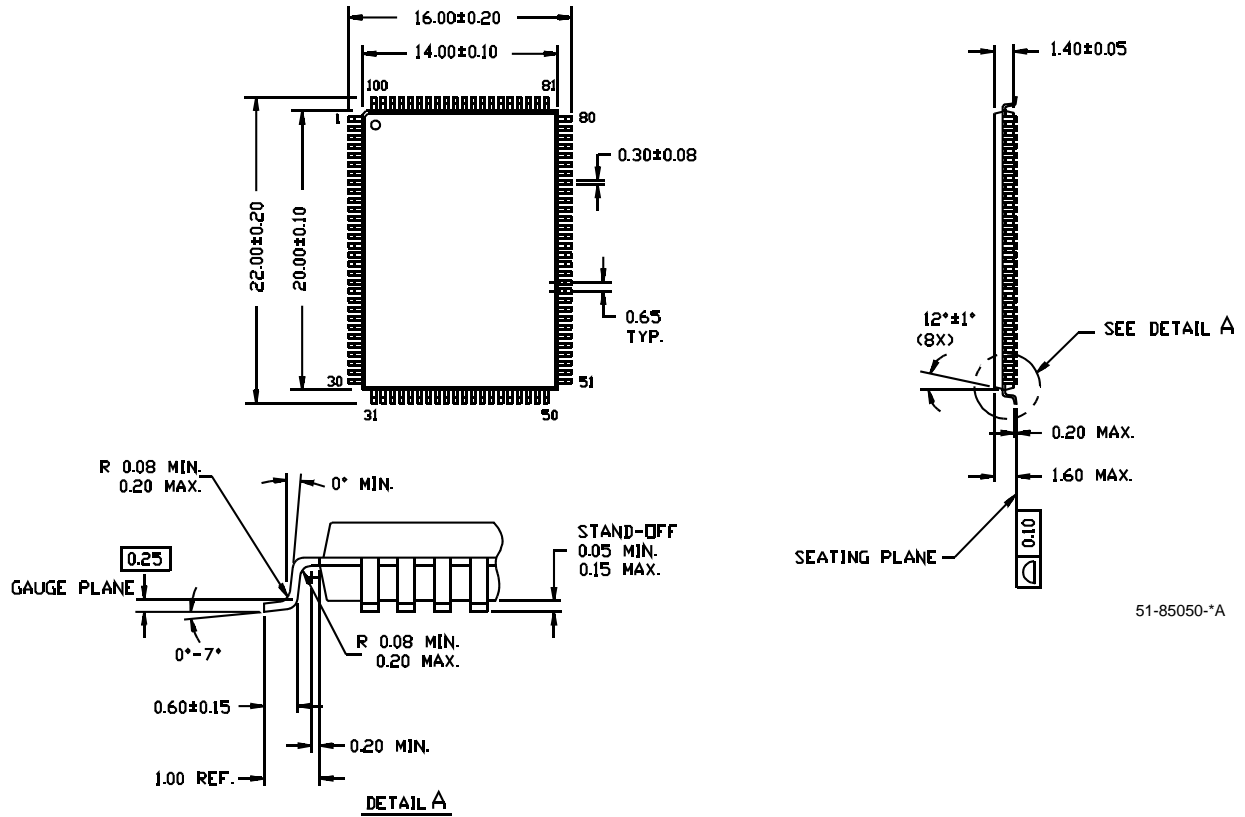

51-85050-\*A



**Package Diagrams (continued)**

**119-Lead BGA (14 x 22 x 2.4 mm) BG119**

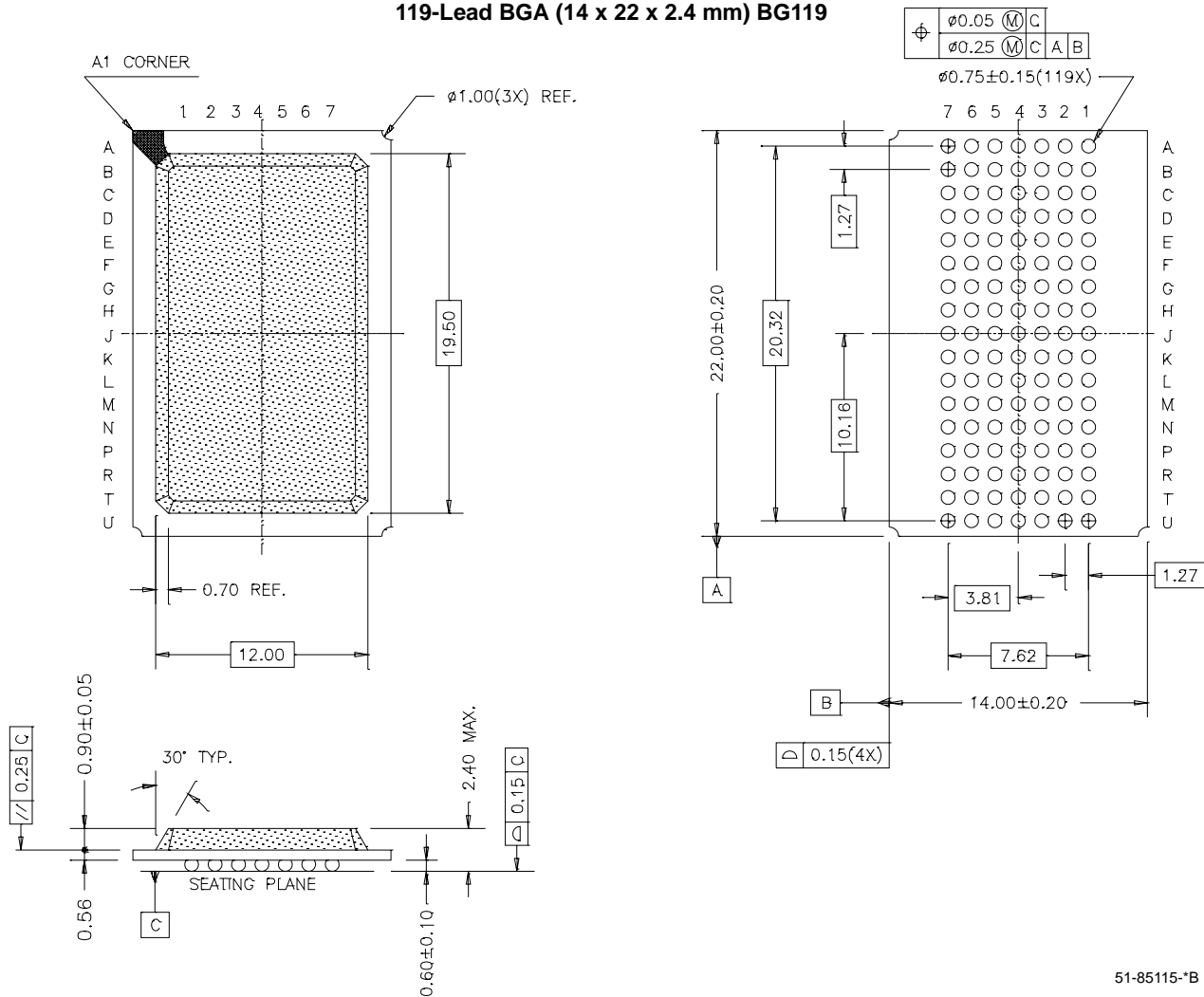

51-85115-B

i486 is a trademark, and Intel and Pentium are registered trademarks, of Intel Corporation. PowerPC is a registered trademark of IBM Corporation. All product and company names mentioned in this document may be trademarks of their respective holders.

**Document History Page**

<b>Document Title: CY7C1327G 4-Mbit (256K x 18) Pipelined Sync SRAM</b>				
<b>Document Number: 38-05519</b>				
<b>REV.</b>	<b>ECN NO.</b>	<b>Issue Date</b>	<b>Orig. of Change</b>	<b>Description of Change</b>
**	224367	See ECN	RKF	New Data Sheet
*A	278513	See ECN	VBL	In Ordering Info section, Changed TQFP to PB-Free TQFP Added PB-Free BG package.