



CYPRESS

CY7C1351

128Kx36 Flow-Through SRAM with NoBL™ Architecture

Features

- Pin compatible and functionally equivalent to ZBT™ devices IDT71V547, MT55L128L36F, and MCM63Z737
- Supports 66-MHz bus operations with zero wait states
 - Data is transferred on every clock
- Internally self-timed output buffer control to eliminate the need to use OE
- Registered inputs for Flow-Through operation
- Byte Write capability
- 128K x 36 common I/O architecture
- Single 3.3V power supply
- Fast clock-to-output times
 - 11.0 ns (for 66-MHz device)
 - 12.0 ns (for 50-MHz device)
 - 14.0 ns (for 40-MHz device)
- Clock Enable (\overline{CEN}) pin to suspend operation
- Synchronous self-timed writes
- Asynchronous Output Enable
- JEDEC-standard 100 TQFP package
- Burst Capability—linear or interleaved burst order
 - Low standby power

Functional Description

The CY7C1351 is a 3.3V, 128K by 36 Synchronous Flow-Through Burst SRAM designed specifically to support unlimited true back-to-back Read/Write operations without the insertion of wait states. The CY7C1351 is equipped with the advanced No Bus Latency™ (NoBL™) logic required to enable consecutive Read/Write operations with data being transferred on every clock cycle. This feature dramatically improves the throughput of data through the SRAM, especially in systems that require frequent Write/Read transitions. The CY7C1351 is pin/functionally compatible to ZBT SRAMs IDT71V547, MT55L128L36F, and MCM63Z737.

All synchronous inputs pass through input registers controlled by the rising edge of the clock. The clock input is qualified by the Clock Enable (\overline{CEN}) signal, which when deasserted suspends operation and extends the previous clock cycle. Maximum access delay from the clock rise is 11.0 ns (66-MHz device).

Write operations are controlled by the four Byte Write Select ($\overline{BWS}_{[3:0]}$) and a Write Enable (\overline{WE}) input. All writes are conducted with on-chip synchronous self-timed write circuitry.

Three synchronous Chip Enables ($\overline{CE}_1, CE_2, \overline{CE}_3$) and an asynchronous Output Enable (\overline{OE}) provide for easy bank selection and output three-state control. In order to avoid bus contention, the output drivers are synchronously three-stated during the data portion of a write sequence.

Logic Block Diagram

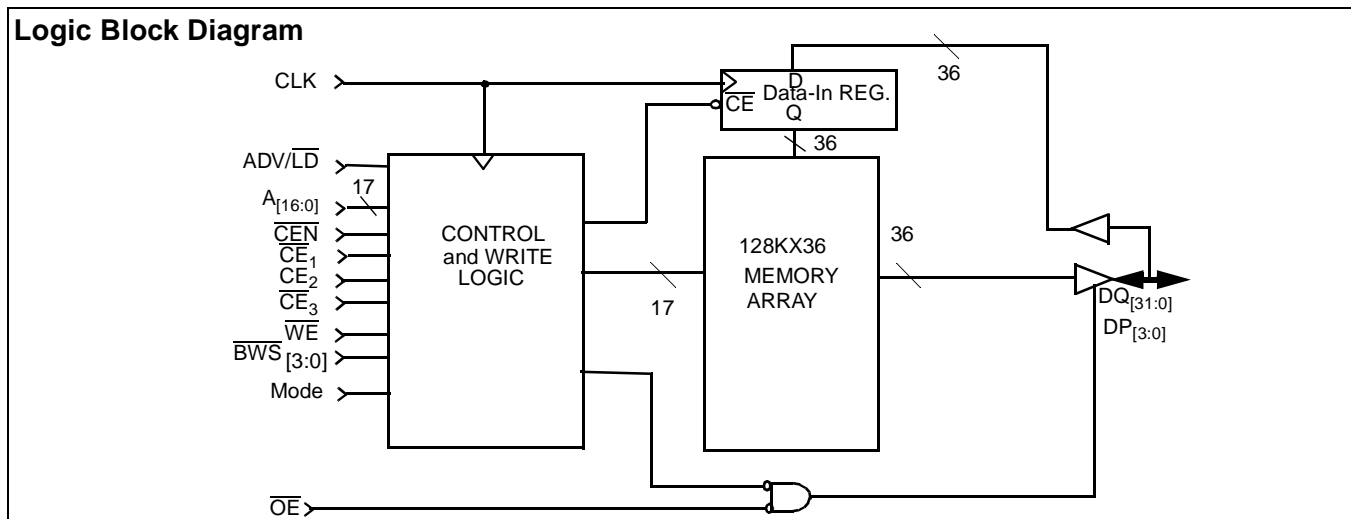

Selection Guide

		7C1351-66	7C1351-50	7C1351-40
Maximum Access Time (ns)		11.0	12.0	14.0
Maximum Operating Current (mA)	Commercial	250 mA	200 mA	175 mA
Maximum CMOS Standby Current (mA)	Commercial	5 mA	5 mA	5 mA

NoBL and No Bus Latency are trademarks of Cypress Semiconductor Corporation.

ZBT is a trademark of Integrated Device Technology.

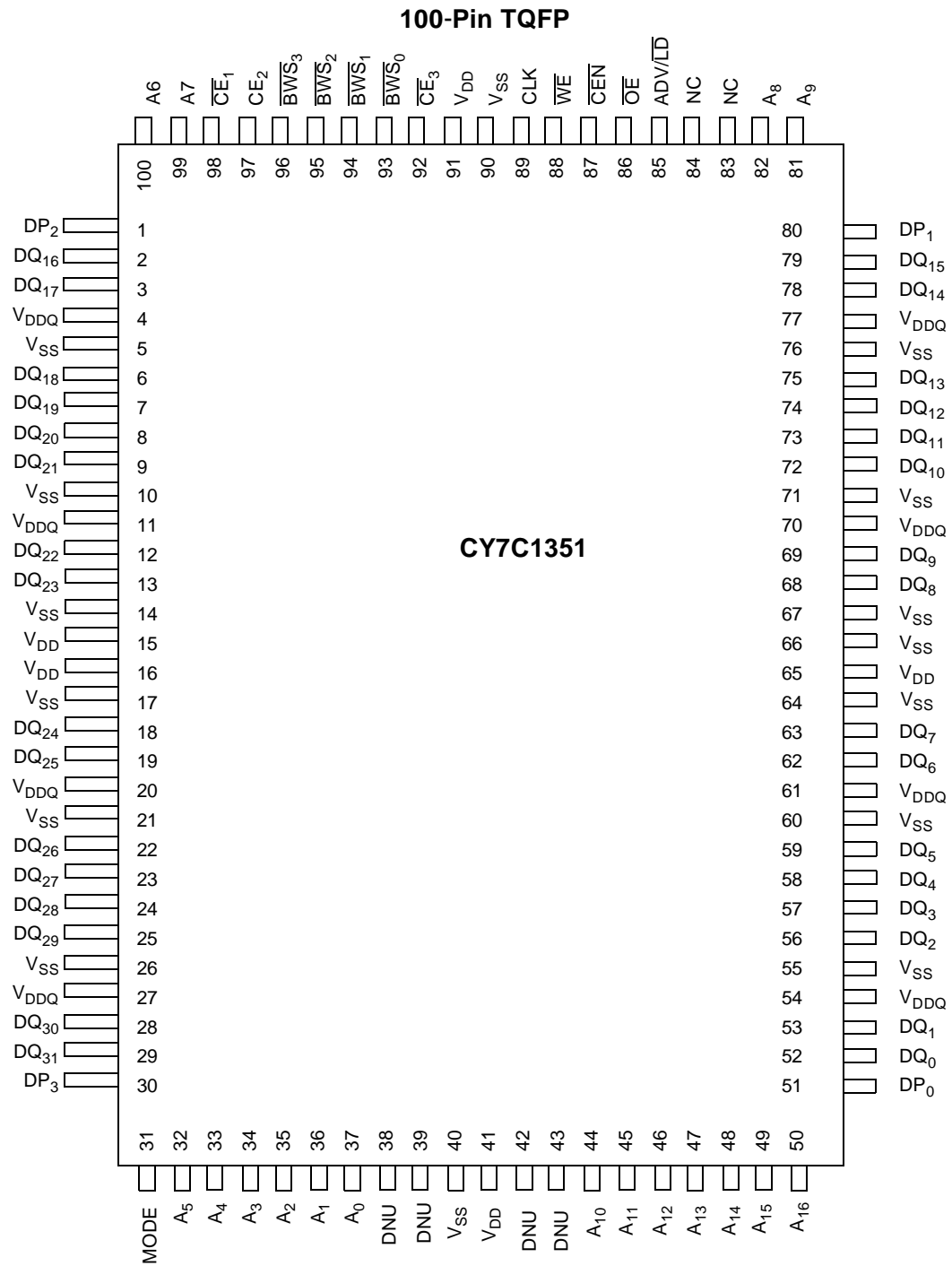
Pin Configuration

Pin Definitions

Pin Number	Name	I/O	Description
50–44, 81–82, 99, 100, 32–37	$A_{[16:0]}$	Input- Synchronous	Address Inputs used to select one of the 133,072 address locations. Sampled at the rising edge of the CLK.
96–93	$BWS_{[3:0]}$	Input- Synchronous	Byte Write Select Inputs, active LOW. Qualified with \overline{WE} to conduct writes to the SRAM. Sampled on the rising edge of CLK. BWS_0 controls $DQ_{[7:0]}$ and DP_0 , BWS_1 controls $DQ_{[15:8]}$ and DP_1 , BWS_2 controls $DQ_{[23:16]}$ and DP_2 , BWS_3 controls $DQ_{[31:24]}$ and DP_3 .
88	\overline{WE}	Input- Synchronous	Write Enable Input, active LOW. Sampled on the rising edge of CLK if \overline{CEN} is active LOW. This signal must be asserted LOW to initiate a write sequence.
85	ADV/\overline{LD}	Input- Synchronous	Advance/Load input used to advance the on-chip address counter or load a new address. When HIGH (and \overline{CEN} is asserted LOW) the internal burst counter is advanced. When LOW, a new address can be loaded into the device for an access. After being deselected, ADV/\overline{LD} should be driven LOW in order to load a new address.
89	CLK	Input-Clock	Clock Input. Used to capture all synchronous inputs to the device. CLK is qualified with \overline{CEN} . CLK is only recognized if \overline{CEN} is active LOW.
98	\overline{CE}_1	Input- Synchronous	Chip Enable 1 Input, active LOW. Sampled on the rising edge of CLK. Used in conjunction with CE_2 and \overline{CE}_3 to select/deselect the device.
97	CE_2	Input- Synchronous	Chip Enable 2 Input, active HIGH. Sampled on the rising edge of CLK. Used in conjunction with \overline{CE}_1 and \overline{CE}_3 to select/deselect the device.
92	\overline{CE}_3	Input- Synchronous	Chip Enable 3 Input, active LOW. Sampled on the rising edge of CLK. Used in conjunction with \overline{CE}_1 and CE_2 to select/deselect the device.
86	\overline{OE}	Input- Asynchronous	Output Enable, active LOW. Combined with the synchronous logic block inside the device to control the direction of the I/O pins. When LOW, the I/O pins are allowed to behave as outputs. When deasserted HIGH, I/O pins are three-stated, and act as input data pins. \overline{OE} is masked during the data portion of a write sequence, during the first clock when emerging from a deselected state and when the device has been deselected.
87	\overline{CEN}	Input- Synchronous	Clock Enable Input, active LOW. When asserted LOW the clock signal is recognized by the SRAM. When deasserted HIGH the clock signal is masked. Since deasserting \overline{CEN} does not deselect the device, \overline{CEN} can be used to extend the previous cycle when required.
29–28, 25–22, 19–18, 13–12, 9–6, 3–2, 79–78, 75–72, 69–68, 63–62, 59–56, 53–52	$DQ_{[31:0]}$	I/O- Synchronous	Bidirectional Data I/O Lines. As inputs, they feed into an on-chip data register that is triggered by the rising edge of CLK. As outputs, they deliver the data contained in the memory location specified by $A_{[16:0]}$ during the previous clock rise of the read cycle. The direction of the pins is controlled by \overline{OE} and the internal control logic. When \overline{OE} is asserted LOW, the pins can behave as outputs. When HIGH, $DQ_{[31:0]}$ are placed in a three-state condition. The outputs are automatically three-stated during the data portion of a write sequence, during the first clock when emerging from a deselected state, and when the device is deselected, regardless of the state of \overline{OE} .
1, 30, 51, 80	$DP_{[3:0]}$	I/O- Synchronous	Bidirectional Data Parity I/O Lines. Functionally, these signals are identical to $DQ_{[31:0]}$. During write sequences, DP_0 is controlled by BWS_0 , DP_1 is controlled by BWS_1 , DP_2 is controlled by BWS_2 , and DP_3 is controlled by BWS_3 .
31	MODE	Input Strap pin	Mode Input. Selects the burst order of the device. Tied HIGH selects the interleaved burst order. Pulled LOW selects the linear burst order. MODE should not change states during operation. When left floating MODE will default HIGH, to an interleaved burst order.
15, 16, 41, 65, 91	V_{DD}	Power Supply	Power supply inputs to the core of the device. Should be connected to 3.3V power supply.
4, 11, 20, 27, 54, 61, 70, 77	V_{DDQ}	I/O Power Supply	Power supply for the I/O circuitry. Should be connected to a 3.3V power supply.
5, 10, 14, 17, 21, 26, 40, 60, 64, 66–67, 55, 71, 76, 90	V_{SS}	Ground	Ground for the device. Should be connected to ground of the system.

Pin Definitions (continued)

Pin Number	Name	I/O	Description
83, 84	NC	-	No Connects. Reserved for address inputs for depth expansion. Pins 83 and 84 will be used for 256K and 512K depths respectively.
38, 39, 42, 43	DNU	-	Do Not Use pins. These pins should be left floating or tied to V_{SS} .

Introduction
Functional Overview

The CY7C1351 is a Synchronous Flow-Through Burst SRAM designed specifically to eliminate wait states during Write-Read transitions. All synchronous inputs pass through input registers controlled by the rising edge of the clock. The clock signal is qualified with the Clock Enable input signal (\overline{CEN}). If \overline{CEN} is HIGH, the clock signal is not recognized and all internal states are maintained. All synchronous operations are qualified with \overline{CEN} . Maximum access delay from the clock rise (t_{CDV}) is 11.0 ns (66-MHz device).

Accesses can be initiated by asserting all three Chip Enables (\overline{CE}_1 , CE_2 , \overline{CE}_3) active at the rising edge of the clock. If Clock Enable (\overline{CEN}) is active LOW and ADV/\overline{LD} is asserted LOW, the address presented to the device will be latched. The access can either be a Read or Write operation, depending on the status of the Write Enable (\overline{WE}). $BWS_{[3:0]}$ can be used to conduct byte write operations.

Write operations are qualified by the Write Enable (\overline{WE}). All writes are simplified with on-chip synchronous self-timed write circuitry.

Three synchronous Chip Enables (\overline{CE}_1 , CE_2 , \overline{CE}_3) and an asynchronous Output Enable (\overline{OE}) simplify depth expansion. All operations (Reads, Writes, and Deselects) are pipelined. ADV/\overline{LD} should be driven LOW once the device has been deselected in order to load a new address for the next operation.

Single Read Accesses

A read access is initiated when the following conditions are satisfied at clock rise: (1) \overline{CEN} is asserted LOW, (2) \overline{CE}_1 , CE_2 and \overline{CE}_3 are ALL asserted active, (3) the Write Enable input signal \overline{WE} is deasserted HIGH, and 4) ADV/\overline{LD} is asserted LOW. The address presented to the address inputs (A_0 – A_{16}) is latched into the Address Register and presented to the memory core and control logic. The control logic determines that a read access is in progress and allows the requested data to propagate to the output buffers. The data is available within 11.0 ns (66-MHz device) provided \overline{OE} is active LOW. After the first clock of the read access the output buffers are controlled by \overline{OE} and the internal control logic. \overline{OE} must be driven LOW in order for the device to drive out the requested data. On the subsequent clock, another operation (Read/Write/Deselect) can be initiated. When the SRAM is deselected at clock rise by one of the chip enable signals, its output will three-stated immediately.

Burst Read Accesses

The CY7C1351 has an on-chip burst counter that allows the user the ability to supply a single address and conduct up to four Reads without reasserting the address inputs. ADV/\overline{LD} must be driven LOW in order to load a new address into the SRAM, as described in the Single Read Access section above. The sequence of the burst counter is determined by the MODE

input signal. A LOW input on MODE selects a linear burst mode, a HIGH selects an interleaved burst sequence. Both burst counters use A_0 and A_1 in the burst sequence, and will wrap around when incremented sufficiently. A HIGH input on ADV/\overline{LD} will increment the internal burst counter regardless of the state of chip enables inputs or \overline{WE} . \overline{WE} is latched at the beginning of a burst cycle. Therefore, the type of access (Read or Write) is maintained throughout the burst sequence.

Single Write Accesses

Write access are initiated when the following conditions are satisfied at clock rise: (1) \overline{CEN} is asserted LOW, (2) \overline{CE}_1 , CE_2 , and \overline{CE}_3 are ALL asserted active, and (3) the write signal \overline{WE} is asserted LOW. The address presented to A_0 – A_{16} is loaded into the Address Register. The write signals are latched into the Control Logic block. The data lines are automatically three-stated regardless of the state of the \overline{OE} input signal. This allows the external logic to present the data on $DQ_{[31:0]}$ and $DP_{[3:0]}$.

On the next clock rise the data presented to $DQ_{[31:0]}$ and $DP_{[3:0]}$ (or a subset for byte write operations, see Write Cycle Description table for details) inputs is latched into the device and the write is complete. Additional accesses (Read/Write/Deselect) can be initiated on this cycle.

The data written during the Write operation is controlled by $BWS_{[3:0]}$ signals. The CY7C1351 provides byte write capability that is described in the Write Cycle Description table. Asserting the Write Enable input (\overline{WE}) with the selected Byte Write Select ($BWS_{[3:0]}$) input will selectively write to only the desired bytes. Bytes not selected during a byte write operation will remain unaltered. A synchronous self-timed write mechanism has been provided to simplify the write operations. Byte write capability has been included in order to greatly simplify Read/Modify/Write sequences, which can be reduced to simple byte write operations.

Because the CY7C1351 is a common I/O device, Data should not be driven into the device while the outputs are active. The Output Enable (\overline{OE}) can be deasserted HIGH before presenting data to the $DQ_{[31:0]}$ and $DP_{[3:0]}$ inputs. Doing so will three-state the output drivers. As a safety precaution, $DQ_{[31:0]}$ and $DP_{[3:0]}$ are automatically three-stated during the data portion of a write cycle, regardless of the state of \overline{OE} .

Burst Write Accesses

The CY7C1351 has an on-chip burst counter that allows the user the ability to supply a single address and conduct up to four Write operations without reasserting the address inputs. ADV/\overline{LD} must be driven LOW in order to load the initial address, as described in the Single Write Access section above. When ADV/\overline{LD} is driven HIGH on the subsequent clock rise, the chip enables (\overline{CE}_1 , CE_2 , and \overline{CE}_3) and \overline{WE} inputs are ignored and the burst counter is incremented. The correct $BWS_{[3:0]}$ inputs must be driven in each cycle of the burst write in order to write the correct bytes of data.

Cycle Description Truth Table^[1, 2, 3, 4, 5, 6]

Operation	Address used	\overline{CE}	\overline{CEN}	ADV/ LD	\overline{WE}	\overline{BWS}_x	CLK	Comments
Deselected	External	1	0	L	X	X	L-H	I/Os three-state following next recognized clock.
Suspend	-	X	1	X	X	X	L-H	Clock ignored, all operations suspended.
Begin Read	External	0	0	0	1	X	L-H	Address latched.
Begin Write	External	0	0	0	0	Valid	L-H	Address latched, data presented two valid clocks later.
Burst Read Operation	Internal	X	0	1	X	X	L-H	Burst Read operation. Previous access was a Read operation. Addresses incremented internally in conjunction with the state of MODE.
Burst Write Operation	Internal	X	0	1	X	Valid	L-H	Burst Write operation. Previous access was a Write operation. Addresses incremented internally in conjunction with the state of MODE. Bytes written are determined by $\overline{BWS}_{[3:0]}$.

Notes:

1. X="Don't Care", 1=Logic HIGH, 0=Logic LOW, \overline{CE} stands for ALL Chip Enables active. $\overline{BWS}_x = 0$ signifies at least one Byte Write Select is active, $\overline{BWS}_x = \text{Valid}$ signifies that the desired byte write selects are asserted, see Write Cycle Description table for details.
2. Write is defined by \overline{WE} and $\overline{BWS}_{[3:0]}$. See Write Cycle Description table for details.
3. The DQ and DP pins are controlled by the current cycle and the \overline{OE} signal.
4. $\overline{CEN}=1$ inserts wait states.
5. Device will power-up deselected and the I/Os in a three-state condition, regardless of \overline{OE} .
6. \overline{OE} assumed LOW.

Interleaved Burst Sequence

First Address	Second Address	Third Address	Fourth Address
Ax+1, Ax	Ax+1, Ax	Ax+1, Ax	Ax+1, Ax
00	01	10	11
01	00	11	10
10	11	00	01
11	10	01	00

Linear Burst Sequence

First Address	Second Address	Third Address	Fourth Address
Ax+1, Ax	Ax+1, Ax	Ax+1, Ax	Ax+1, Ax
00	01	10	11
01	10	11	00
10	11	00	01
11	00	01	10

Write Cycle Description^[1, 2]

Function	WE	BWS ₃	BWS ₂	BWS ₁	BWS ₀
Read	1	X	X	X	X
Write – No bytes written	0	1	1	1	1
Write Byte 0 – (DQ _[7:0] and DP ₀)	0	1	1	1	0
Write Byte 1 – (DQ _[15:8] and DP ₁)	0	1	1	0	1
Write Bytes 1, 0	0	1	1	0	0
Write Byte 2 – (DQ _[23:16] and DP ₂)	0	1	0	1	1
Write Bytes 2, 0	0	1	0	1	0
Write Bytes 2, 1	0	1	0	0	1
Write Bytes 2, 1, 0	0	1	0	0	0
Write Byte 3 – (DQ _[31:24] and DP ₃)	0	0	1	1	1
Write Bytes 3, 0	0	0	1	1	0
Write Bytes 3, 1	0	0	1	0	1
Write Bytes 3, 1, 0	0	0	1	0	0
Write Bytes 3, 2	0	0	0	1	1
Write Bytes 3, 2, 0	0	0	0	1	0
Write Bytes 3, 2, 1	0	0	0	0	1
Write All Bytes	0	0	0	0	0

Maximum Ratings

(Above which the useful life may be impaired. For user guidelines, not tested.)

Storage Temperature -65°C to +150°C
 Ambient Temperature with Power Applied -55°C to +125°C
 Supply Voltage on V_{DD} Relative to GND -0.5V to +4.6V
 DC Voltage Applied to Outputs in High Z State^[7] -0.5V to $V_{DDQ} + 0.5V$
 DC Input Voltage^[7] -0.5V to $V_{DDQ} + 0.5V$

Current into Outputs (LOW) 20 mA
 Static Discharge Voltage >2001V (per MIL-STD-883, Method 3015)
 Latch-Up Current >200 mA

Operating Range

Range	Ambient Temperature ^[8]	V_{DD}/V_{DDQ}
Com'l	0°C to +70°C	3.3V ± 5%

Electrical Characteristics Over the Operating Range

Parameter	Description	Test Conditions	Min.	Max.	Unit
V_{DD}	Power Supply Voltage		3.135	3.465	V
V_{DDQ}	I/O Supply Voltage		3.135	3.465	V
V_{OH}	Output HIGH Voltage	$V_{DD} = \text{Min.}, I_{OH} = -4.0 \text{ mA}^{[9]}$	2.4		V
V_{OL}	Output LOW Voltage	$V_{DD} = \text{Min.}, I_{OL} = 8.0 \text{ mA}^{[9]}$		0.4	V
V_{IH}	Input HIGH Voltage		2.0	$V_{DD} + 0.3V$	V
V_{IL}	Input LOW Voltage ^[7]		-0.3	0.8	V
I_X	Input Load Current	$GND \leq V_I \leq V_{DDQ}$	-5	5	mA
	Input Current of MODE		-30	30	mA
I_{OZ}	Output Leakage Current	$GND \leq V_I \leq V_{DDQ}$, Output Disabled	-5	5	mA
I_{CC}	V_{DD} Operating Supply	$V_{DD} = \text{Max.}, I_{OUT} = 0 \text{ mA}, f = f_{MAX} = 1/t_{CYC}$	15-ns cycle, 66 MHz	250	mA
			20-ns cycle, 50 MHz	200	mA
			25-ns cycle, 40 MHz	175	mA
I_{SB1}	Automatic CE Power-Down Current—TTL Inputs	Max. V_{DD} , Device Deselected, $V_{IN} \geq V_{IH}$ or $V_{IN} \leq V_{IL}$, $f = f_{MAX} = 1/t_{CYC}$	15-ns cycle, 66 MHz	60	mA
			20-ns cycle, 50 MHz	40	mA
			25-ns cycle, 40 MHz	35	mA
I_{SB2}	Automatic CE Power-Down Current—CMOS Inputs	Max. V_{DD} , Device Deselected, $V_{IN} \leq 0.3V$ or $V_{IN} \geq V_{DDQ} - 0.3V$, $f = 0$		5	mA
I_{SB3}	Automatic CE Power-Down Current—CMOS Inputs	Max. V_{DD} , Device Deselected, or $V_{IN} \leq 0.3V$ or $V_{IN} \geq V_{DDQ} - 0.3V$, $f = f_{MAX} = 1/t_{CYC}$	15-ns cycle, 66 MHz	50	mA
			20-ns cycle, 50 MHz	40	mA
			25-ns cycle, 40 MHz	35	mA

Notes:

7. Minimum voltage equals -2.0V for pulse duration less than 20 ns.
8. T_A is the case temperature.
9. The load used for V_{OH} and V_{OL} testing is shown in figure (b) of the AC Test Loads.

Capacitance^[10]

Parameter	Description	Test Conditions	Max.	Unit
C_{IN}	Input Capacitance	$T_A = 25^\circ\text{C}$, $f = 1\text{ MHz}$, $V_{DD} = 3.3\text{V}$ $V_{DDQ} = 3.3\text{V}$	4	pF
C_{CLK}	Clock Input Capacitance		4	pF
$C_{I/O}$	Input/Output Capacitance		4	pF

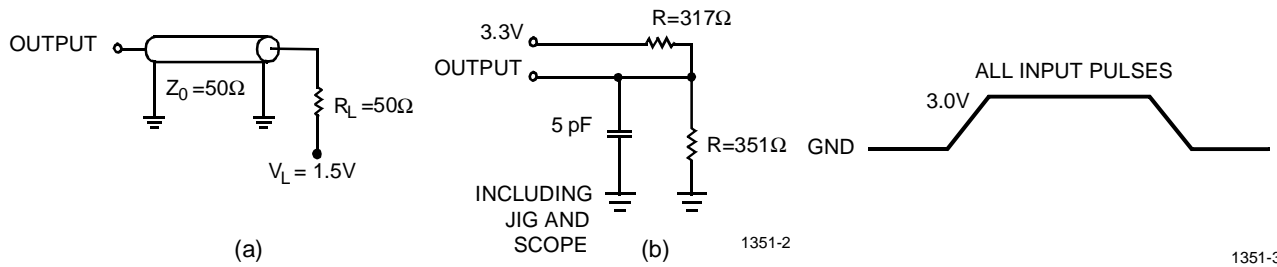
AC Test Loads and Waveforms

Thermal Resistance

Description	Test Conditions	Symbol	TQFP Typ.	Units	Notes
Thermal Resistance (Junction to Ambient)	Still Air, soldered on a 4.25 x 1.125 inch, 4-layer printed circuit board	Θ_{JA}	28	$^\circ\text{C/W}$	10
Thermal Resistance (Junction to Case)		Θ_{JC}	4	$^\circ\text{C/W}$	10

Note:

10. Tested initially and after any design or process change that may affect these parameters.

Switching Characteristics Over the Operating Range^[11, 12, 13]

Parameter	Description	-66		-50		-40		Unit
		Min.	Max.	Min.	Max.	Min.	Max.	
t _{CYC}	Clock Cycle Time	15.0		20.0		25.0		ns
t _{CH}	Clock HIGH	5.0		6.0		7.0		ns
t _{CL}	Clock LOW	5.0		6.0		7.0		ns
t _{AS}	Address Set-Up Before CLK Rise	2.0		2.0		2.5		ns
t _{AH}	Address Hold After CLK Rise	0.5		1.0		1.0		ns
t _{CDV}	Data Output Valid After CLK Rise		11.0		12.0		14.0	ns
t _{DOH}	Data Output Hold After CLK Rise	1.5		1.5		1.5		ns
t _{CENS}	\overline{CEN} Set-Up Before CLK Rise	2.0		2.0		2.5		ns
t _{CENH}	\overline{CEN} Hold After CLK Rise	0.5		1.0		1.0		ns
t _{WES}	\overline{WE} , $\overline{BWS}_{[3:0]}$ Set-Up Before CLK Rise	2.0		2.0		2.5		ns
t _{WEH}	\overline{WE} , $\overline{BWS}_{[3:0]}$ Hold After CLK Rise	0.5		1.0		1.0		ns
t _{ALS}	$\overline{ADV}/\overline{LD}$ Set-Up Before CLK Rise	2.0		2.0		2.5		ns
t _{ALH}	$\overline{ADV}/\overline{LD}$ Hold after CLK Rise	0.5		1.0		1.0		ns
t _{DS}	Data Input Set-Up Before CLK Rise	1.7		2.0		2.5		ns
t _{DH}	Data Input Hold After CLK Rise	0.5		1.0		1.0		ns
t _{CES}	Chip Select Set-Up	2.0		2.0		2.5		ns
t _{CEH}	Chip Select Hold After CLK Rise	0.5		1.0		1.0		ns
t _{CHZ}	Clock to High-Z ^[10, 12, 13, 14]		5.0		5.0		5.0	ns
t _{CLZ}	Clock to Low-Z ^[10, 12, 13, 14]	3.0		3.0		3.0		ns
t _{EOHZ}	\overline{OE} HIGH to Output High-Z ^[10, 12, 13, 14]		6.0		7.0		8.0	ns
t _{EOLZ}	\overline{OE} LOW to Output Low-Z ^[10, 12, 13, 14]	0		0		0		ns
t _{EOV}	\overline{OE} LOW to Output Valid ^[12]		6.0		7.0		8.0	ns

Notes:

- Unless otherwise noted, test conditions assume signal transition time of 2 ns or less, timing reference levels of 1.5V, input pulse levels of 0 to 3.0V, and output loading shown in (a) of AC Test Loads.
- t_{CHZ}, t_{CLZ}, t_{EOV}, t_{EOLZ}, and t_{EOHZ} are specified with A/C test conditions shown in part (a) of AC Test Loads. Transition is measured ± 200 mV from steady-state voltage.
- At any given voltage and temperature, t_{EOHZ} is less than t_{EOLZ} and t_{CHZ} is less than t_{CLZ} to eliminate bus contention between SRAMs when sharing the same data bus. These specifications do not imply a bus contention condition, but reflect parameters guaranteed over worst case user conditions. Device is designed to achieve High-Z prior to Low-Z under the same system conditions.
- This parameter is sampled and not 100% tested.

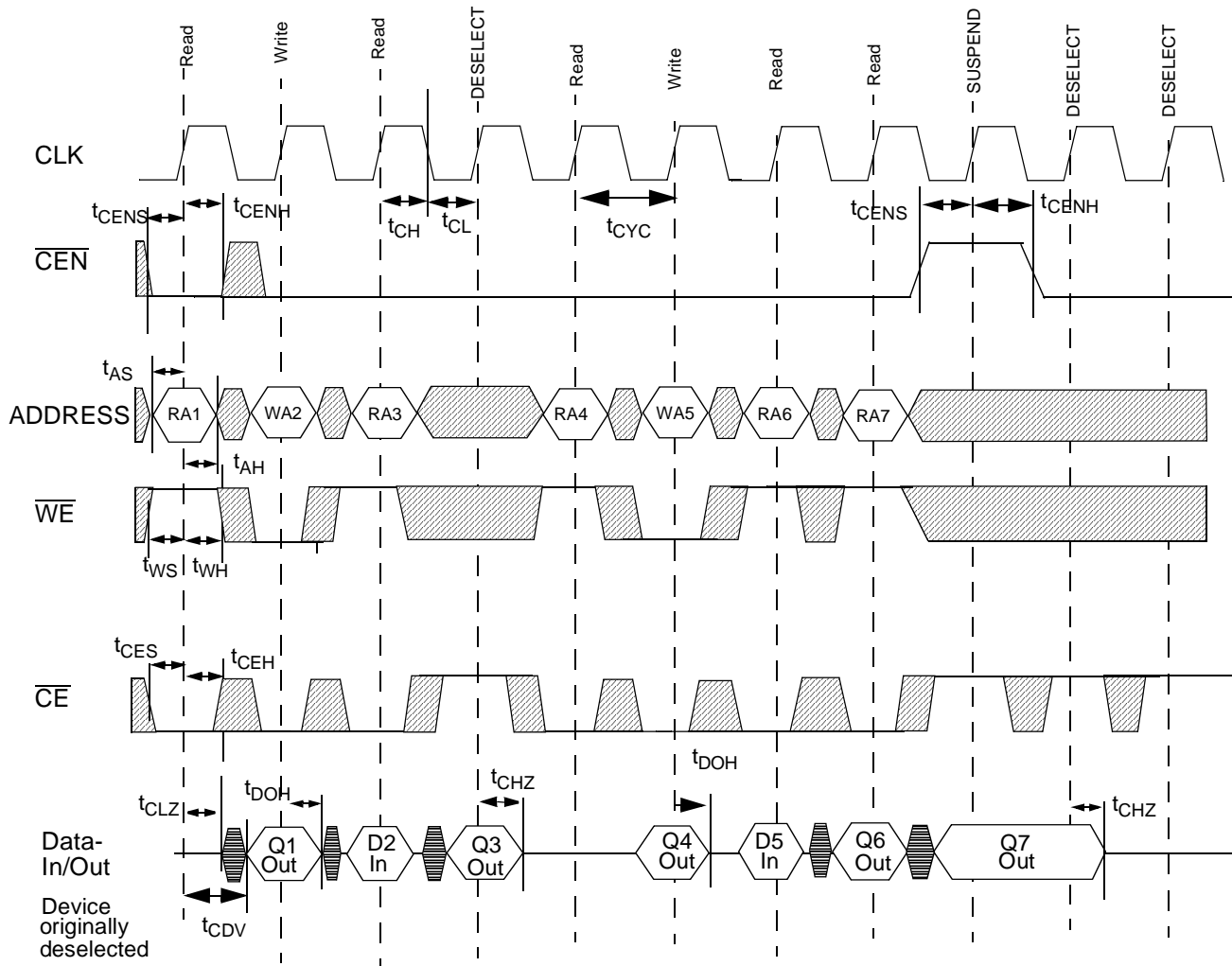
Switching Waveforms
Read/Write/Deselect Sequence

\overline{WE} is the combination of \overline{WE} & \overline{BWS}_x to define a write cycle (see Write Cycle Description table).
 \overline{CE} is the combination of \overline{CE}_1 , CE_2 , and \overline{CE}_3 . All chip selects need to be active in order to select the device. Any chip select can deselect the device. RAX stands for Read Address X, WAX stands for Write Address X, Dx stands for Data-in X, Qx stands for Data-out X.



 = DON'T CARE  = UNDEFINED

Switching Waveforms (continued)

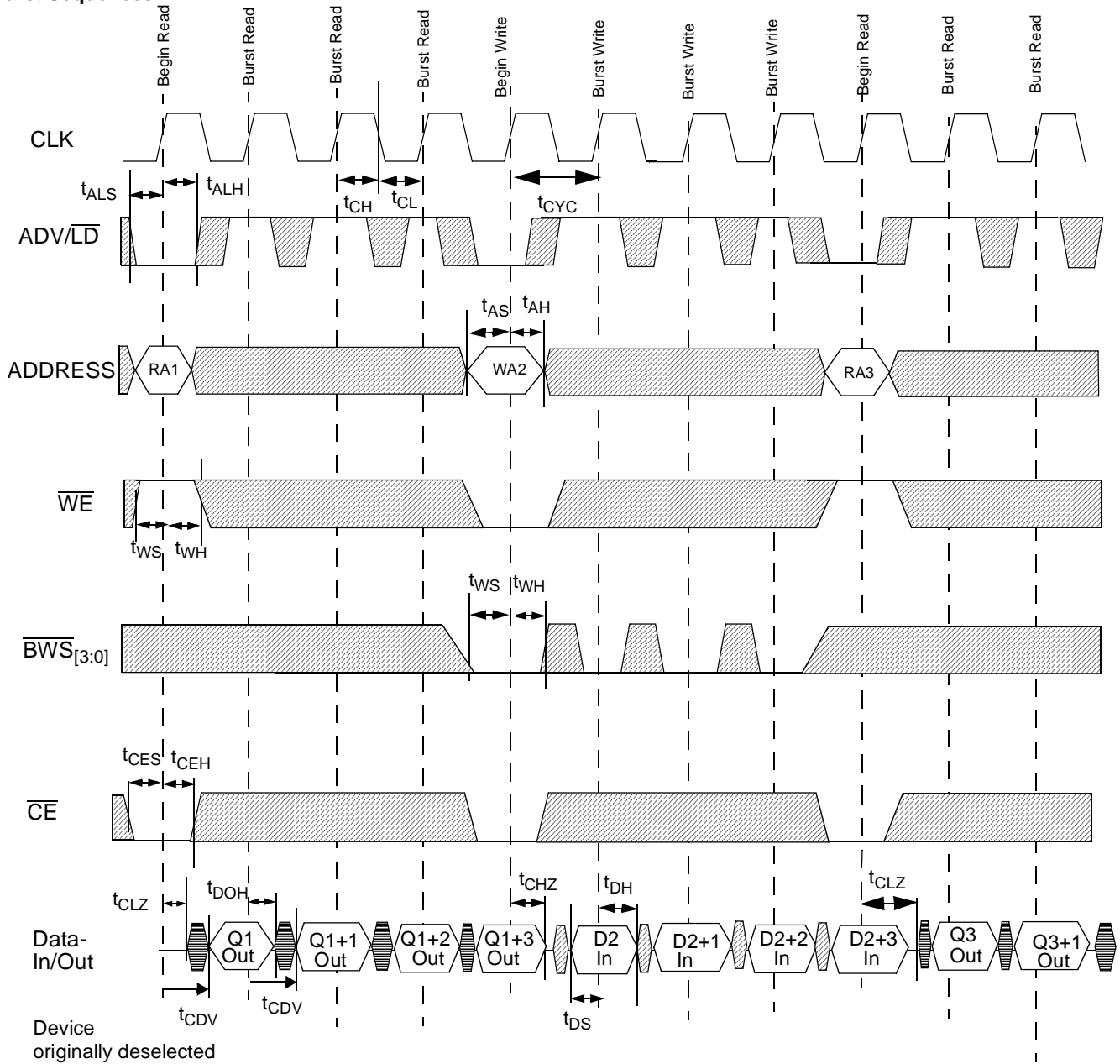
Burst Sequences



The combination of \overline{WE} & $\overline{BWS}_{[3:0]}$ defines a write cycle (see Write Cycle Description table). \overline{CE} is the combination of \overline{CE}_1 , \overline{CE}_2 , and \overline{CE}_3 . All chip enables need to be active in order to select the device. Any chip enable can deselect the device. RAX stands for Read Address X, WAX stands for Write Address X, Dx stands for Data-in for location X, Qx stands for Data-out for location X. \overline{CEN} held LOW. During burst writes, byte writes can be conducted by asserting the appropriate $\overline{BWS}_{[3:0]}$ input signals. Burst order determined by the state of the MODE input. \overline{CEN} held LOW. \overline{OE} held LOW.

 = DON'T CARE  = UNDEFINED

Switching Waveforms (continued)

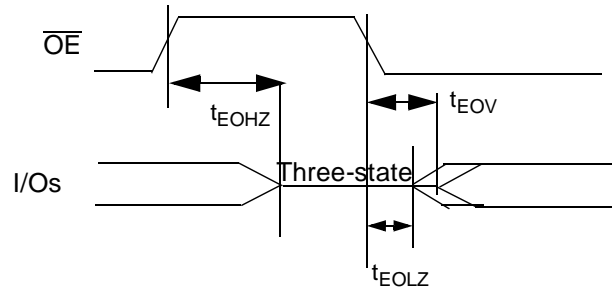
 \overline{OE} Timing

Ordering Information

Speed (MHz)	Ordering Code	Package Name	Package Type	Operating Range
66	CY7C1351-66AC	A101	100-Lead 14 x 20 x 1.4 mm Thin Quad Flat Pack	Commercial
50	CY7C1351-50AC	A101	100-Lead 14 x 20 x 1.4 mm Thin Quad Flat Pack	Commercial
40	CY7C1351-40AC	A101	100-Lead 14 x 20 x 1.4 mm Thin Quad Flat Pack	Commercial

Document #: 38-00691-C

