

# Sealed Subminiature Snap Action Switch D2HW

**Smallest Sealed Snap-Action Switch in the Industry With a Long Stroke For Reliable ON/OFF Action**

- Conforms to IP67
- Case dimensions 22% smaller than conventional models
- Extra-long stroke even without levers (OT: 1.4 mm)
- All models are lead-free, including lead wire models
- RoHS Compliant

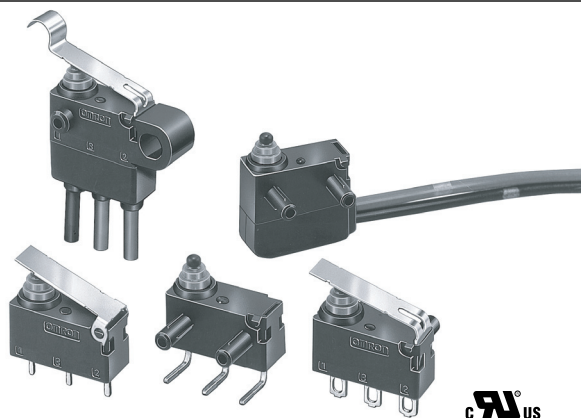

## Ordering Information

Add "S" to the end of the model number for the UL/CSA-approved version. Consult your OMRON sales representative for details.









### ■ PCB-Mounted Models

Actuator	Terminals		Contact form	Model		
				With posts on right	With posts on left	Without posts
Pin plunger 	For PCB	Straight	SPDT	---	---	D2HW-A201D
		Angled		D2HW-BR201DR	D2HW-BL201DL	---
Hinge lever 		Straight		---	---	D2HW-A211D
		Angled		D2HW-BR211DR	D2HW-BL211DL	---
Long hinge lever 		Straight		---	---	D2HW-A221D
		Angled		D2HW-BR221DR	D2HW-BL221DL	---
Simulated roller lever 		Straight		---	---	D2HW-A231D
		Angled		D2HW-BR231DR	D2HW-BL231DL	---

### ■ Models with Solder Terminals or Lead Wire Terminals

Actuator	Terminals		Contact form	Model		
				With posts on right	With posts on left	M3-screw mounting
Pin plunger 	Solder		SPDT	D2HW-BR201H	D2HW-BL201H	D2HW-C201H
	Lead wire	Downwards	SPDT	D2HW-BR201M	D2HW-BL201M	D2HW-C201M
			SPST-NC	D2HW-BR202M	D2HW-BL202M	D2HW-C202M
			SPST-NO	D2HW-BR203M	D2HW-BL203M	D2HW-C203M





(This table continues on the next page.)

Actuator	Terminals		Contact form	Model		
				With posts on right 	With posts on left 	M3-screw mounting 
Pin plunger 	Lead wire	Right-side	SPST-NC	D2HW-BR202MR	D2HW-BL202MR	D2HW-C202MR
			SPST-NO	D2HW-BR203MR	D2HW-BL203MR	D2HW-C203MR
		Left-side	SPST-NC	D2HW-BR202ML	D2HW-BL202ML	—
			SPST-NO	D2HW-BR203ML	D2HW-BL203ML	—
Hinge lever 	Solder		SPDT	D2HW-BR211H	D2HW-BL211H	D2HW-C211H
	Lead wire	Downwards	SPDT	D2HW-BR211M	D2HW-BL211M	D2HW-C211M
			SPST-NC	D2HW-BR212M	D2HW-BL212M	D2HW-C212M
			SPST-NO	D2HW-BR213M	D2HW-BL213M	D2HW-C213M
		Right-side	SPST-NC	D2HW-BR212MR	D2HW-BL212MR	D2HW-C212MR
			SPST-NO	D2HW-BR213MR	D2HW-BL213MR	D2HW-C213MR
		Left-side	SPST-NC	D2HW-BR212ML	D2HW-BL212ML	—
	SPST-NO		D2HW-BR213ML	D2HW-BL213ML	—	
Long hinge lever 	Solder		SPDT	D2HW-BR221H	D2HW-BL221H	D2HW-C221H
	Lead wire	Downwards	SPDT	D2HW-BR221M	D2HW-BL221M	D2HW-C221M
			SPST-NC	D2HW-BR222M	D2HW-BL222M	D2HW-C222M
			SPST-NO	D2HW-BR223M	D2HW-BL223M	D2HW-C223M
		Right-side	SPST-NC	D2HW-BR222MR	D2HW-BL222MR	D2HW-C222MR
			SPST-NO	D2HW-BR223MR	D2HW-BL223MR	D2HW-C223MR
		Left-side	SPST-NC	D2HW-BR222ML	D2HW-BL222ML	—
	SPST-NO		D2HW-BR223ML	D2HW-BL223ML	—	
Simulated roller hinge lever 	Solder		SPDT	D2HW-BR231H	D2HW-BL231H	D2HW-C231H
	Lead wire	Downwards	SPDT	D2HW-BR231M	D2HW-BL231M	D2HW-C231M
			SPST-NC	D2HW-BR232M	D2HW-BL232M	D2HW-C232M
			SPST-NO	D2HW-BR233M	D2HW-BL233M	D2HW-C233M
		Right-side	SPST-NC	D2HW-BR232MR	D2HW-BL232MR	D2HW-C232MR
			SPST-NO	D2HW-BR233MR	D2HW-BL233MR	D2HW-C233MR
		Left-side	SPST-NC	D2HW-BR232ML	D2HW-BL232ML	—
	SPST-NO		D2HW-BR233ML	D2HW-BL233ML	—	
Hinge roller lever 	Solder		SPDT	D2HW-BR241H	D2HW-BL241H	D2HW-C241H
	Lead wire	Downwards	SPDT	D2HW-BR241M	D2HW-BL241M	D2HW-C241M
			SPST-NC	D2HW-BR242M	D2HW-BL242M	D2HW-C242M
			SPST-NO	D2HW-BR243M	D2HW-BL243M	D2HW-C243M
		Right-side	SPST-NC	D2HW-BR242MR	D2HW-BL242MR	D2HW-C242MR
			SPST-NO	D2HW-BR243MR	D2HW-BL243MR	D2HW-C243MR
		Left-side	SPST-NC	D2HW-BR242ML	D2HW-BL242ML	---
	SPST-NO		D2HW-BR243ML	D2HW-BL243ML	---	
Leaf lever 	Solder		SPDT	D2HW-BR261H	D2HW-BL261H	D2HW-C261H
	Lead wire	Downwards	SPDT	D2HW-BR261M	D2HW-BL261M	D2HW-C261M
			SPST-NC	D2HW-BR262M	D2HW-BL262M	D2HW-C262M
			SPST-NO	D2HW-BR263M	D2HW-BL263M	D2HW-C263M
		Right-side	SPST-NC	D2HW-BR262MR	D2HW-BL262MR	D2HW-C262MR
			SPST-NO	D2HW-BR263MR	D2HW-BL263MR	D2HW-C263MR
		Left-side	SPST-NC	D2HW-BR262ML	D2HW-BL262ML	—
	SPST-NO		D2HW-BR263ML	D2HW-BL263ML	—	

Add "S" to the end of the model number for the UL/CSA-approved version. Consult your OMRON sales representative for details.

(This table continues on the next page.)

Ordering Information - continued from previous page

Actuator	Terminals		Contact form	Model		
				With posts on right 	With posts on left 	M3-screw mounting 
Simulated roller leaf lever 	Solder		SPDT	D2HW-BR271H	D2HW-BL271H	D2HW-C271H
	Lead wire	Downwards	SPDT	D2HW-BR271M	D2HW-BL271M	D2HW-C271M
			SPST-NC	D2HW-BR272M	D2HW-BL272M	D2HW-C272M
			SPST-NO	D2HW-BR273M	D2HW-BL273M	D2HW-C273M
		Right-side	SPST-NC	D2HW-BR272MR	D2HW-BL272MR	D2HW-C272MR
			SPST-NO	D2HW-BR273MR	D2HW-BL273MR	D2HW-C273MR
		Left-side	SPST-NC	D2HW-BR272ML	D2HW-BL272ML	—
	SPST-NO		D2HW-BR273ML	D2HW-BL273ML	—	
Long leaf lever 	Lead wire	Downwards	SPDT	D2HW-BR281M	D2HW-BL281M	D2HW-C281M
			SPST-NC	D2HW-BR282M	D2HW-BL282M	D2HW-C282M
			SPST-NO	D2HW-BR283M	D2HW-BL283M	D2HW-C283M
		Right-side	SPST-NC	—	—	D2HW-C282MR
			SPST-NO	—	—	D2HW-C283MR

- Note:** 1. The length of standard lead wires (AVSS 0.5 = standard with UL1007 AWG 24 used on UL/CSA models.) for lead wire models is 30 cm (12 in).  
 2. Add "S" to the end of the model number for the UL/CSA-approved version. Consult your OMRON sales representative for details.

## Specifications

### ■ Characteristics

Item	Specification
Operating speed	1 mm to 500 mm/s (for pin plunger models)
Operating frequency	30 operations/min.
Insulation resistance	100 MΩ min. (at 500 VDC)
Contact resistance (initial value)	100 mΩ max. (lead wire models: 150 mΩ max.)
Dielectric strength	600 VAC, 50/60 Hz for 1 min. between terminals of the same polarity 1,500 VAC, 50/60 Hz for 1 min. between current-carrying metal parts and ground, and between each terminal and non-current-carrying metal parts
Vibration resistance (See note 2)	Malfunction: 10 to 55 Hz, 1.5-mm double amplitude
Shock resistance (See note 2)	Destruction: 1,000 m/s <sup>2</sup> max. Malfunction: 300 m/s <sup>2</sup> max.
Life expectancy (Consult Omron for test conditions)	Mechanical: 1,000,000 operations min. (30 operations/min.) Electrical: 100,000 operations min. (20 operations/min.)
Degree of protection	IP67 (excluding the terminals on terminal models)
Degree of protection against electric shock	Class I
Proof tracking index (PTI)	175
Ambient operating temperature	-40 to 85°C (with no icing)
Ambient operating humidity	95% max. (in temperature range 5° to 35°C)
Weight	Approx. 0.7 g (for pin plunger models with terminals)

- Note:** 1. The data given above are initial values.  
 2. For the pin plunger models, the above values apply for use at the free position, operating position, and total travel position. For the lever models, they apply at the total travel position. The values shown apply for malfunctions of 1 ms max.

### ■ Ratings

Rated voltage (V)	Resistive load
125 VAC	0.1 A
12 VDC	2 A
24 VDC	1 A
42 VDC	0.5 A

**Note:** The ratings apply under the following test conditions: Ambient Temperature = 20±2°C, Ambient Humidity = 65±5%, Operating frequency = 30 operations/min.

## ■ Contact Form

### SPDT

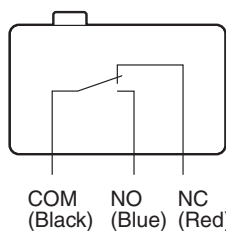

### SPST-NC (Lead Wire Models Only)

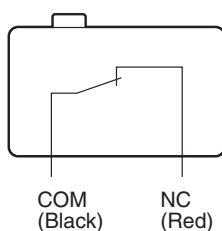

### SPST-NO (Lead Wire Models Only)

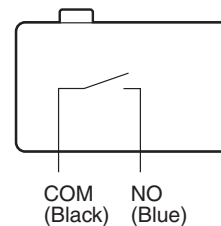

**Note:** Lead wire colors are indicated in parentheses.

## ■ Approved Standards

Consult your OMRON sales representative for specific models with standard approvals.

### UL1054 (File No. E41515)/CSA C22.2 No. 55 (UL approval)

Rated voltage	D2HW
125 VAC	0.1 A
12 VDC	2 A

## ■ Contact Specifications

Item	Specification
Specification	Crossbar
Material	Gold alloy
Gap (standard value)	0.5 mm
Minimum applicable load (see note)	1 mA at 5 VDC

**Note:** Minimum applicable loads are indicated by N standard reference values. This value represents the failure rate at a 60% ( $\lambda_{60}$ ) reliability level (JIS C5003).

The equation  $\lambda_{60}=0.5 \times 10^{-6}/\text{operations}$  indicates that a failure rate of 1/2,000,000 operations can be expected at a reliability level of 60%.

# Dimensions

## Mounting Structure and Reference Positions for Operating Characteristics

- Note:** 1. All units are in millimeters unless otherwise indicated.  
 2. Dimensions not indicated in the diagrams have a tolerance of  $\pm 0.2$  mm  
 3. The reference positions used for FP, OP, and TTP values are as shown below for each type of mounting.

### Models without Posts D2HW-A□

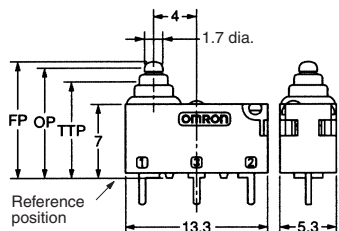

### Models with Posts D2HW-B□

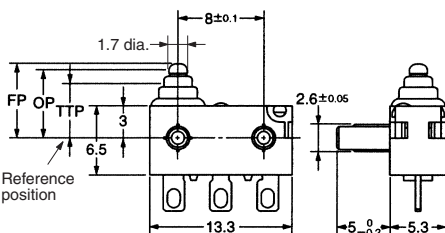

### M3-screw Mounting Models D2HW-C□

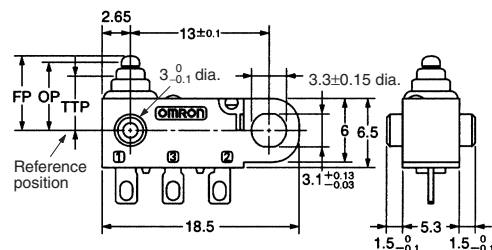

### Mounting Hole Dimensions (Reference)

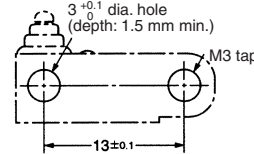
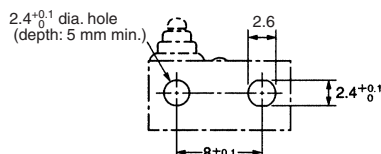

## Terminals

### Straight PCB Terminals

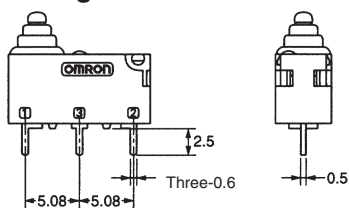

### PCB Cutout Dimensions (Reference)

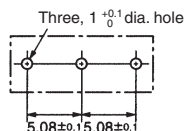

### Angled PCB Terminals

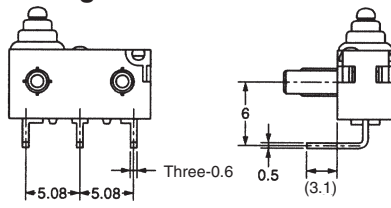

### PCB Cutout Dimensions (Reference)

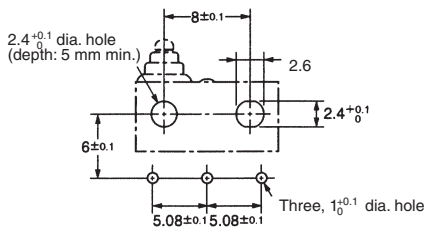

### Solder Terminals

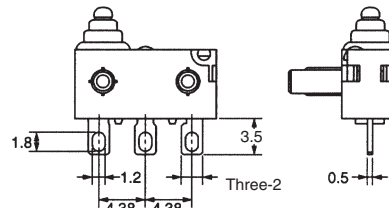

### Lead Wires Downwards

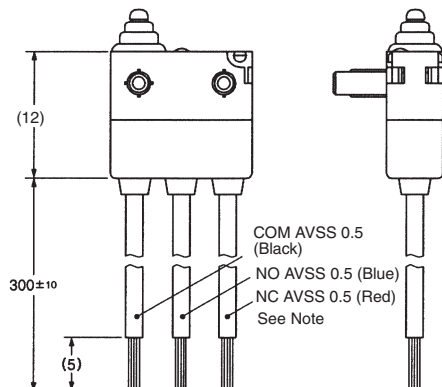

### Lead Wires on Left-side

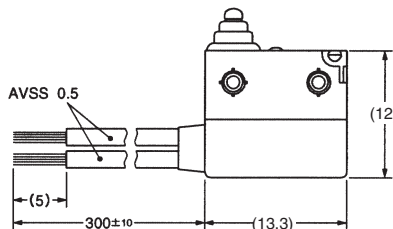

### Lead Wires on Right-side

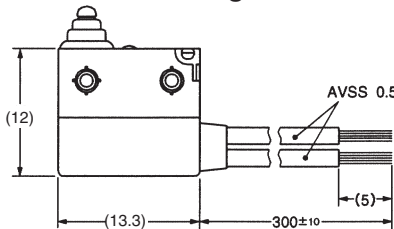

**Note:** UL1007 AWG24 wires are used for UL/CSA approved models.

Angled terminal directions are shown below.

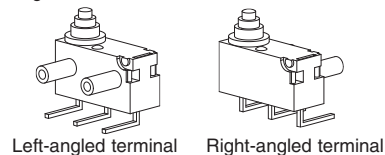

## ■ Dimensions and Operating Characteristics

- Note:** 1. All units are in millimeters unless otherwise indicated.  
 2. Dimensions not indicated in the diagrams below have a tolerance of  $\pm 0.2$  mm.  
 3. The operating characteristics are for operation in the A direction (  $\downarrow$  ).

### Pin Plunger Models

D2HW-□20□□

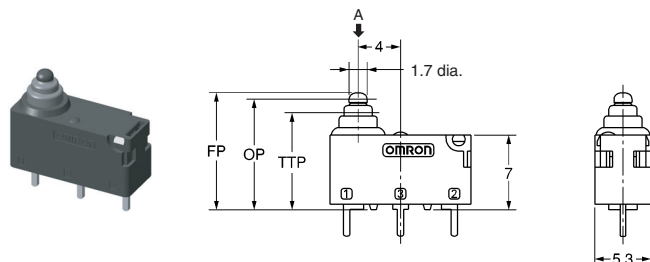

Characteristic	Models without posts	Models with posts and M3-mounting models
OF max. RF min.	0.75 N {76 gf} 0.10 N {10 gf}	
OT ref. MD max.	1.4 mm (reference value) 0.25 mm	
FP max. OP TTP max.	11.2 mm 10.4 $\pm$ 0.2 mm 9.1 mm	7.2 mm 6.4 $\pm$ 0.2 mm 5.1 mm

### Hinge Lever Models

D2HW-□21□□

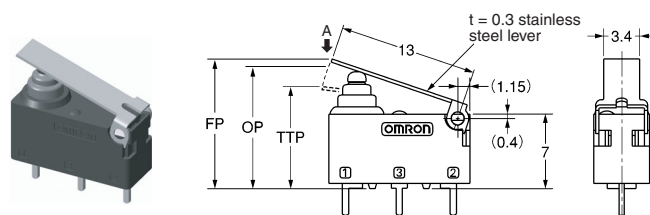

Characteristic	Models without posts	Models with posts and M3-mounting models
OF max. RF min.	0.75 N {76 gf} 0.07 N {7 gf}	
OT ref. MD max.	1.6 mm (reference value) 0.5 mm	
FP max. OP TTP max.	12.8 mm 11.5 $\pm$ 0.5 mm 10 mm	8.8 mm 7.5 $\pm$ 0.5 mm 6 mm

### Long Hinge Lever Models

D2HW-□22□□

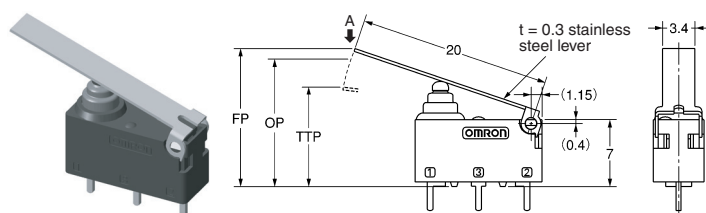

Characteristic	Models without posts	Models with posts and M3-mounting models
OF max. RF min.	0.5 N {50 gf} 0.03 N {3 gf}	
OT ref. MD max.	2.5 mm (reference value) 0.8 mm	
FP max. OP TTP max.	15.5 mm 13.3 $\pm$ 0.8 mm 11 mm	11.5 mm 9.3 $\pm$ 0.8 mm 7 mm

### Simulated Roller Hinge Lever Models

D2HW-□23□□

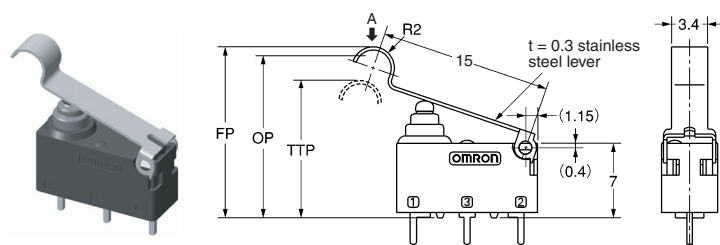

Characteristic	Models without posts	Models with posts and M3-mounting models
OF max. RF min.	0.65 N {66 gf} 0.05 N {5 gf}	
OT ref. MD max.	1.9 mm (reference value) 0.5 mm	
FP max. OP TTP max.	16.5 mm 15.2 $\pm$ 0.5 mm 13.5 mm	12.5 mm 11.2 $\pm$ 0.5 mm 9.5 mm

- Note:** 1. All units are in millimeters unless otherwise indicated.  
 2. Dimensions not indicated in the diagrams below have a tolerance of  $\pm 0.2$  mm.  
 3. The operating characteristics are for operation in the A direction (  $\downarrow$  ).

### Hinge Roller Lever Models

D2HW-□24□□

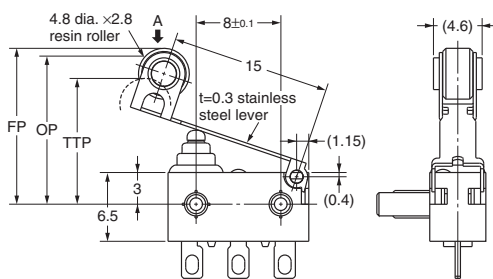
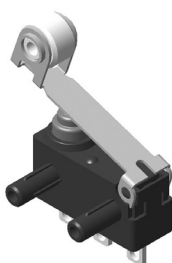

Characteristic	Models with posts and M3-mounting models
OF max. RF min.	0.65 N {66 gf} 0.03 N {3 gf}
OT ref. MD max.	1.9 mm (reference value) 0.6 mm
FP max. OP TTP max.	15.3 mm 14±0.6 mm 12.3 mm

### Leaf Lever Models

D2HW-□26□□

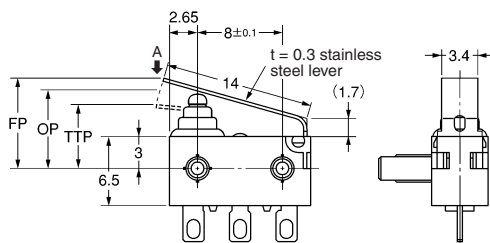
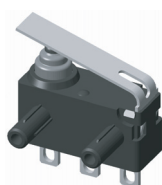

Characteristic	Models with posts and M3-mounting models
OF max. RF min.	1.8 N {183 gf} 0.20 N {20 gf}
OT ref. MD max.	1.8 mm (reference value) 0.5 mm
FP max. OP TTP max.	9.3 mm 7.4±0.5 mm 5.8 mm

### Simulated Roller Leaf Lever Models

D2HW-□27□□

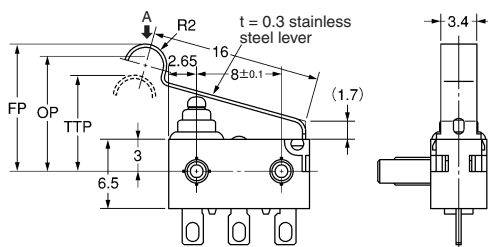

Characteristic	Models with posts and M3-mounting models
OF max. RF min.	1.8 N {183 gf} 0.20 N {20 gf}
OT ref. MD max.	2.0 mm (reference value) 0.5 mm
FP max. OP TTP max.	12.5 mm 10.8±0.5 mm 8.9 mm

### Long Leaf Lever Models

D2HW-□28□□

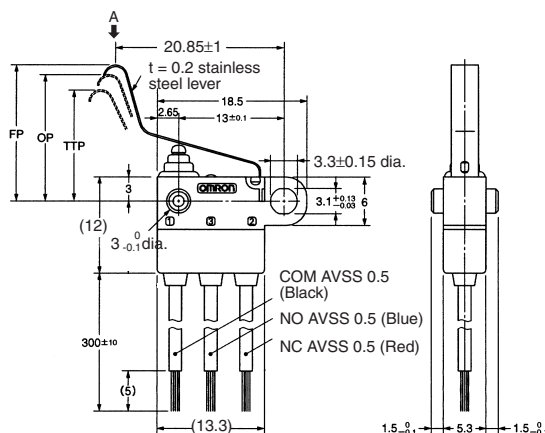
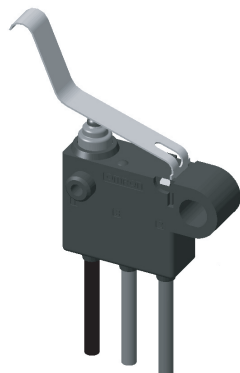

Characteristic	Models with posts and M3-mounting models
OF max. RF min.	0.9 N {92 gf} 0.05 N {5 gf}
OT ref. MD max.	2.8 mm (reference value) 0.7 mm
FP max. OP TTP max.	19 mm 15.4±1.5 mm 12.8 mm

**Note:** UL1007 AWG24 wires are used for UL/CSA approved models.

# Precautions

Be sure to read the precautions and information common to all Snap Action and Detection Switches, contained in the Technical User's Guide, "Snap Action Switches, Technical Information" for correct use.

## ■ Cautions

### Degree of Protection

IEC Publication 529, degree of protection IP67.

Do not use this product in water. Although molded lead wire models satisfy the test conditions for the standard given below, this test is to check the ingress of water into the switch enclosure after submerging the Switch in water for a given time. Satisfying this test condition does not mean that the Switch can be used in water.

Do not operate the Switch when it is exposed to water spray, or when water drops adhere to the Switch surface, or during sudden temperature changes, otherwise water may intrude into the interior of the Switch due to a suction effect.

Prevent the Switch from coming into contact with oil and chemicals. Otherwise, damage to or deterioration of Switch materials may result.

Do not use the Switch in areas where it is exposed to silicon adhesives, oil, or grease, otherwise faulty contact may result due to the generation of silicon oxide.

### Terminal Connection

When soldering the lead wire to the terminal, first insert the lead wire conductor through the terminal hole and then conduct soldering.

Made sure that the capacity of the soldering iron is 30 W maximum. Do not take more than 3 s to solder the switch terminal. Improper soldering involving an excessively high temperature or excessive soldering time may deteriorate the characteristics of the Switch.

When soldering the lead wire to the PCB terminal, pay careful attention so that the flux and solder liquid level does not exceed the PCB level.

### Side-actuated (Cam/Dog) Operation

When using a cam or dog to operate the Switch, factors such as the operating speed, operating frequency, push-button indentation, and material and shape of the cam or dog will affect the durability of the Switch. Confirm performance specifications under actual operation conditions before using the Switch in applications.

IEC Publication 529, degree of protection IP67.

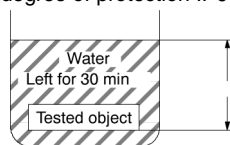

## ■ Correct Use

### Mounting

Turn OFF the power supply before mounting or removing the Switch, wiring, or performing maintenance or inspection. Failure to do so may result in electric shock or burning.

For M3-screw mounting models, use M3 mounting screws with plane washers or spring washers to securely mount the Switch. Tighten the screws to a torque of 0.27 to 0.29 N·m. Exceeding the specified torque may result in deterioration of the sealing or damage.

For models with posts, secure the posts by thermal caulking or by pressing into an attached device. When pressed into an attached device, provide guides on the opposite ends of the posts to ensure that they do not fall out or rattle.

Mount the Switch onto a flat surface. Mounting on an uneven surface may cause deformation of the Switch, resulting in faulty operation or damage.

### Operating Body

Use an operating body with low frictional resistance and of a shape that will not interfere with the sealing rubber, otherwise the plunger may be damaged or the sealing may deteriorate.

### Handling

Do not handle the Switch in a way that may cause damage to the sealing rubber.

When handling the Switch, ensure that pressure is not applied to the posts in the directions shown in the following diagram. Also, ensure that uneven pressure or pressure in a direction other than the operating direction is not applied to the Actuator as shown in the following diagram. Otherwise, the post, Actuator, or Switch may be damaged, or the service life may be reduced.

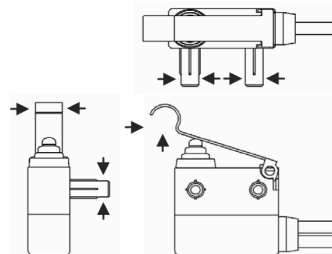

### Wiring Molded Lead Wire Models

When wiring molded lead wire models, ensure that there is no weight on the wire or that there are no sharp bends near the parts where the wire is drawn out. Otherwise, damage to the Switch or deterioration in the sealing may result.

### Using Micro Loads

Even when using micro load models within the operating range, inrush currents or surges may decrease the life expectancy of the Switch. Therefore, insert a contact protection circuit where necessary.



# Omron Electronic Components, LLC

## Terms and Conditions of Sales

### I. GENERAL

- Definitions:** The words used herein are defined as follows.
  - Terms:** These terms and conditions
  - Seller:** Omron Electronic Components LLC and its subsidiaries
  - Buyer:** The buyer of Products, including any end user in section III through VI
  - Products:** Products and/or services of Seller
  - Including:** Including without limitation
- Offer; Acceptance:** These Terms are deemed part of all quotations, acknowledgments, invoices, purchase orders and other documents, whether electronic or in writing, relating to the sale of Products by Seller. Seller hereby objects to any Terms proposed in Buyer's purchase order or other documents which are inconsistent with, or in addition to, these Terms.
- Distributor:** Any distributor shall inform its customer of the contents after and including section III of these Terms.

### II. SALES

- Prices; Payment:** All prices stated are current, subject to change without notice by Seller. Buyer agrees to pay the price in effect at the time the purchase order is accepted by Seller. Payments for Products received are due net 30 days unless otherwise stated in the invoice. Buyer shall have no right to set off any amounts against the amount owing in respect of this invoice.
- Discounts:** Cash discounts, if any, will apply only on the net amount of invoices sent to Buyer after deducting transportation charges, taxes and duties, and will be allowed only if (a) the invoice is paid according to Seller's payment terms and (b) Buyer has no past due amounts owing to Seller.
- Interest:** Seller, at its option, may charge Buyer 1.5% interest per month or the maximum legal rate, whichever is less, on any balance not paid within the stated terms.
- Orders:** Seller will accept no order less than 200 U.S. dollars net billing.
- Currencies:** If the prices quoted herein are in a currency other than U.S. dollars, Buyer shall make remittance to Seller at the then current exchange rate most favorable to Seller; provided that if remittance is not made when due, Buyer will convert the amount to U.S. dollars at the then current exchange rate most favorable to Seller available during the period between the due date and the date remittance is actually made.
- Governmental Approvals:** Buyer shall be responsible for all costs involved in obtaining any government approvals regarding the importation or sale of the Products.
- Taxes:** All taxes, duties and other governmental charges (other than general real property and income taxes), including any interest or penalties thereon, imposed directly or indirectly on Seller or required to be collected directly or indirectly by Seller for the manufacture, production, sale, delivery, importation, consumption or use of the Products sold hereunder (including customs duties and sales, excise, use, turnover and license taxes) shall be charged to and remitted by Buyer to Seller.
- Financial:** If the financial position of Buyer at any time becomes unsatisfactory to Seller, Seller reserves the right to stop shipments or require satisfactory security or payment in advance. If Buyer fails to make payment or otherwise comply with these Terms or any related agreement, Seller may (without liability and in addition to other remedies) cancel any unshipped portion of Products sold hereunder and stop any Products in transit until Buyer pays all amounts, including amounts payable hereunder, whether or not then due, which are owing to it by Buyer. Buyer shall in any event remain liable for all unpaid accounts.
- Cancellation; Etc:** Orders are not subject to rescheduling or cancellation unless Buyer indemnifies Seller fully against all costs or expenses arising in connection therewith.
- Force Majeure:** Seller shall not be liable for any delay or failure in delivery resulting from causes beyond its control, including earthquakes, fires, floods, strikes or other labor disputes, shortage of labor or materials, accidents to machinery, acts of sabotage, riots, delay in or lack of transportation or the requirements of any government authority.
- Shipping; Delivery:** Unless otherwise expressly agreed in writing by Seller:
  - All sales and shipments of Products shall be FOB shipping point (unless otherwise stated in writing by Seller), at which point title to and all risk of loss of the Products shall pass from Seller to Buyer, provided that Seller shall retain a security interest in the Products until the full purchase price is paid by Buyer;
  - Delivery and shipping dates are estimates only; and
  - Seller will package Products as it deems proper for protection against normal handling and extra charges apply to special conditions.
- Claims:** Any claim by Buyer against Seller for shortage or damage to the Products occurring before delivery to the carrier or any claim related to pricing or other charges must be presented in detail in writing to Seller within 30 days of receipt of shipment.

### III. PRECAUTIONS

- Suitability:** IT IS THE BUYER'S SOLE RESPONSIBILITY TO ENSURE THAT ANY OMRON PRODUCT IS FIT AND SUFFICIENT FOR USE IN A MOTORIZED VEHICLE APPLICATION. BUYER SHALL BE SOLELY RESPONSIBLE FOR DETERMINING APPROPRIATENESS OF THE PARTICULAR PRODUCT WITH RESPECT TO THE BUYER'S APPLICATION INCLUDING (A) ELECTRICAL OR ELECTRONIC COMPONENTS, (B) CIRCUITS, (C) SYSTEM ASSEMBLIES, (D) END PRODUCT, (E) SYSTEM, (F) MATERIALS OR SUBSTANCES OR (G) OPERATING ENVIRONMENT. Buyer acknowledges that it alone has determined that the Products will meet their requirements of the intended use in all cases. Buyer must know and observe all prohibitions of use applicable to the Product/s.
- Use with Attention:** The followings are some examples of applications for which particular attention must be given. This is not intended to be an exhaustive list of all possible use of any Product, nor to imply that any use listed may be suitable for any Product:
  - Outdoor use, use involving potential chemical contamination or electrical interference.

- Use in consumer Products or any use in significant quantities.
  - Energy control systems, combustion systems, railroad systems, aviation systems, medical equipment, amusement machines, vehicles, safety equipment, and installations subject to separate industry or government regulations.
  - Systems, machines, and equipment that could present a risk to life or property.
- Prohibited Use:** NEVER USE THE PRODUCT FOR AN APPLICATION INVOLVING SERIOUS RISK TO LIFE OR PROPERTY WITHOUT ENSURING THAT THE SYSTEM AS A WHOLE HAS BEEN DESIGNED TO ADDRESS THE RISKS, AND THAT THE PRODUCT IS PROPERLY RATED AND INSTALLED FOR THE INTENDED USE WITHIN THE OVERALL EQUIPMENT OR SYSTEM.
  - Motorized Vehicle Application:** USE OF ANY PRODUCT/S FOR A MOTORIZED VEHICLE APPLICATION MUST BE EXPRESSLY STATED IN THE SPECIFICATION BY SELLER.
  - Programmable Products:** Seller shall not be responsible for the Buyer's programming of a programmable Product.

### IV. WARRANTY AND LIMITATION

- Warranty:** Seller's exclusive warranty is that the Products will be free from defects in materials and workmanship for a period of twelve months from the date of sale by Seller (or such other period expressed in writing by Seller). SELLER MAKES NO WARRANTY OR REPRESENTATION, EXPRESS OR IMPLIED, ABOUT ALL OTHER WARRANTIES, NON-INFRINGEMENT, MERCHANTABILITY OR FITNESS FOR A PARTICULAR PURPOSE OF THE PRODUCTS.
- Buyer Remedy:** Seller's sole obligation hereunder shall be to replace (in the form originally shipped with Buyer responsible for labor charges for removal or replacement thereof) the non-complying Product or, at Seller's election, to repay or credit Buyer an amount equal to the purchase price of the Product; provided that there shall be no liability for Seller or its affiliates unless Seller's analysis confirms that the Products were correctly handled, stored, installed and maintained and not subject to contamination, abuse, misuse or inappropriate modification. Return of any Products by Buyer must be approved in writing by Seller before shipment.
- Limitation on Liability:** SELLER AND ITS AFFILIATES SHALL NOT BE LIABLE FOR SPECIAL, INDIRECT, INCIDENTAL OR CONSEQUENTIAL DAMAGES, LOSS OF PROFITS OR PRODUCTION OR COMMERCIAL LOSS IN ANY WAY CONNECTED WITH THE PRODUCTS, WHETHER SUCH CLAIM IS BASED IN CONTRACT, WARRANTY, NEGLIGENCE OR STRICT LIABILITY. FURTHER, IN NO EVENT SHALL LIABILITY OF SELLER OR ITS AFFILIATES EXCEED THE INDIVIDUAL PRICE OF THE PRODUCT ON WHICH LIABILITY IS ASSERTED.
- Indemnities:** Buyer shall indemnify and hold harmless Seller, its affiliates and its employees from and against all liabilities, losses, claims, costs and expenses (including attorney's fees and expenses) related to any claim, investigation, litigation or proceeding (whether or not Seller is a party) which arises or is alleged to arise from Buyer's acts or omissions under these Terms or in any way with respect to the Products.

### V. INFORMATION; ETC.

- Intellectual Property:** The intellectual property embodied in the Products is the exclusive property of Seller and its affiliates and Buyer shall not attempt to duplicate it in any way without the written permission of Seller. Buyer (at its own expense) shall indemnify and hold harmless Seller and defend or settle any action brought against Seller to the extent that it is based on a claim that any Product made to Buyer specifications infringed intellectual property rights of another party.
- Property; Confidentiality:** Notwithstanding any charges to Buyer for engineering or tooling, all engineering and tooling shall remain the exclusive property of Seller. All information and materials supplied by Seller to Buyer relating to the Products are confidential and proprietary, and Buyer shall limit distribution thereof to its trusted employees and strictly prevent disclosure to any third party.
- Performance Data:** Performance data is provided as a guide in determining suitability and does not constitute a warranty. It may represent the result of Seller's test conditions, and the users must correlate it to actual application requirements.
- Change In Specifications:** Product specifications and descriptions may be changed at any time based on improvements or other reasons. It is Seller's practice to change part numbers when published ratings or features are changed, or when significant engineering changes are made. However, some specifications of the Product may be changed without any notice.
- Errors And Omissions:** The information on Seller's website or in other documentation has been carefully checked and is believed to be accurate; however, no responsibility is assumed for clerical, typographical or proofreading errors or omissions.
- Export Controls:** Buyer shall comply with all applicable laws, regulations and licenses regarding (a) export of the Products or information provided by Seller; (b) sale of Products to forbidden or other proscribed persons or organizations; (c) disclosure to non-citizens of regulated technology or information.

### VI. MISCELLANEOUS

- Waiver:** No failure or delay by Seller in exercising any right and no course of dealing between Buyer and Seller shall operate as a waiver of rights by Seller.
- Assignment:** Buyer may not assign its rights hereunder without Seller's written consent.
- Law:** These Terms are governed by Illinois law (without regard to conflict of laws). Federal and state courts in Cook County, Illinois have exclusive jurisdiction for any dispute hereunder.
- Amendment:** These Terms constitute the entire agreement between Buyer and Seller relating to the Products, and no provision may be changed or waived unless in writing signed by the parties.
- Severability:** If any provision hereof is rendered ineffective or invalid, such provision shall not invalidate any other provision.

# Certain Precautions on Specifications and Use

1. **Suitability for Use.** Seller shall not be responsible for conformity with any standards, codes or regulations which apply to the combination of the Product in Buyer's application or use of the Product. At Buyer's request, Seller will provide applicable third party certification documents identifying ratings and limitations of use which apply to the Product. This information by itself is not sufficient for a complete determination of the suitability of the Product in combination with the end product, machine, system, or other application or use. Buyer shall be solely responsible for determining appropriateness of the particular Product with respect to Buyer's application, product or system. Buyer shall take application responsibility in all cases but the following is a non-exhaustive list of applications for which particular attention must be given:
  - (i) Outdoor use, uses involving potential chemical contamination or electrical interference, or conditions or uses not described in this document.
  - (ii) Energy control systems, combustion systems, railroad systems, aviation systems, medical equipment, amusement machines, vehicles, safety equipment, and installations subject to separate industry or government regulations.
  - (iii) Use in consumer products or any use in significant quantities.
  - (iv) Systems, machines and equipment that could present a risk to life or property. Please know and observe all prohibitions of use applicable to this product.

NEVER USE THE PRODUCT FOR AN APPLICATION INVOLVING SERIOUS RISK TO LIFE OR PROPERTY WITHOUT ENSURING THAT THE SYSTEM AS A WHOLE HAS BEEN DESIGNED TO ADDRESS THE RISKS, AND THAT THE OMRON PRODUCT IS PROPERLY RATED AND INSTALLED FOR THE INTENDED USE WITHIN THE OVERALL EQUIPMENT OR SYSTEM.
2. **Programmable Products.** Seller shall not be responsible for the user's programming of a programmable product, or any consequence thereof.
3. **Performance Data.** Performance data given in this publication is provided as a guide for the user in determining suitability and does not constitute a warranty. It may represent the result of Seller's test conditions, and the users must correlate it to actual application requirements. Actual performance is subject to Seller's Warranty and Limitations of Liability.
4. **Change in Specifications.** Product specifications and accessories may be changed at any time based on improvements and other reasons. It is our practice to change part numbers when published ratings or features are changed, or when significant construction changes are made. However, some specifications of the Product may be changed without any notice. When in doubt, special part numbers may be assigned to fix or establish key specifications for your application. Please consult with your Seller representative at any time to confirm actual specifications of purchased Product.
5. **Errors and Omissions.** The information in this publication has been carefully checked and is believed to be accurate; however, no responsibility is assumed for clerical, typographical or proofreading errors, or omissions.
6. **RoHS Compliance.** Where indicated, our products currently comply, to the best of our knowledge as of the date of this publication, with the requirements of the European Union's Directive on the Restriction of certain Hazardous Substances ("RoHS"), although the requirements of RoHS do not take effect until July 2006. These requirements may be subject to change. Please consult our website for current information.

Complete "Terms and Conditions of Sale" for product purchase and use are on Omron's website at <http://www.components.omron.com> – under the "About Us" tab, in the Legal Matters section.

**ALL DIMENSIONS SHOWN ARE IN MILLIMETERS.**

To convert millimeters into inches, multiply by 0.03937. To convert grams into ounces, multiply by 0.03527.

# OMRON®

**OMRON ELECTRONIC  
COMPONENTS LLC**

55 E. Commerce Drive, Suite B  
Schaumburg, IL 60173

**847-882-2288**

**OMRON ON-LINE**

Global - <http://www.omron.com>

USA - <http://www.components.omron.com>