

# SHINDENGEN

## Schottky Rectifiers (SBD)

Single

# D5S9M

## 90V 5A

### FEATURES

- Tj150°C
- P<sub>RRSM</sub> avalanche guaranteed
- Fully Isolated Molding

### APPLICATION

- Switching power supply
- DC/DC converter
- Home Appliances, Office Equipment
- Telecommunication

### OUTLINE DIMENSIONS

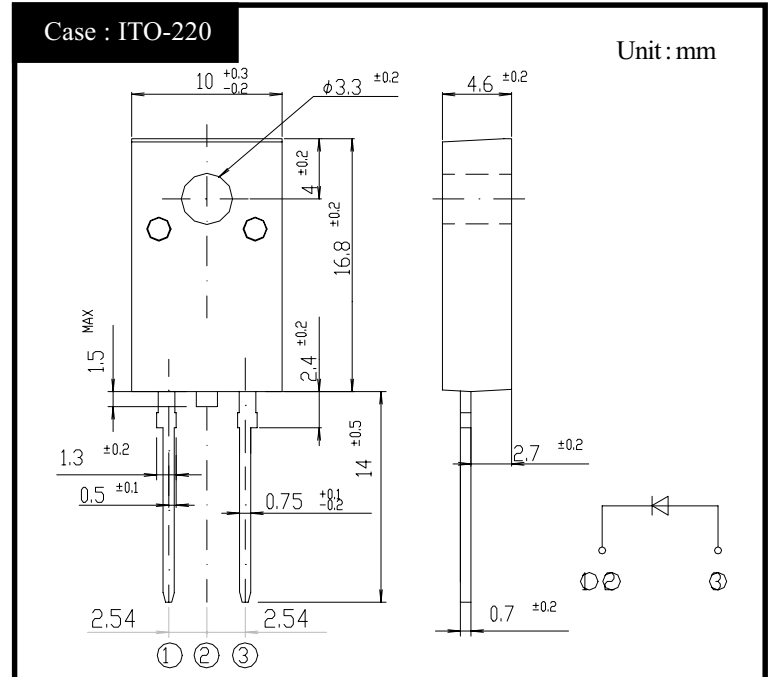

### RATINGS

#### ● Absolute Maximum Ratings (If not specified T<sub>c</sub> =25°C)

Item	Symbol	Conditions	Ratings	Unit
Storage Temperature	T <sub>stg</sub>		-40~150	°C
Operating Junction Temperature	T <sub>j</sub>		150	°C
Maximum Reverse Voltage	V <sub>RM</sub>		90	V
Repetitive Peak Surge Reverse Voltage	V <sub>RRSM</sub>	Pulse width 0.5ms, duty 1/40	100	V
Average Rectified Forward Current	I <sub>O</sub>	50Hz sine wave, R-load, T <sub>c</sub> =121°C	5	A
Peak Surge Forward Current	I <sub>FSM</sub>	50Hz sine wave, Non-repetitive 1 cycle peak value, T <sub>j</sub> =125°C	100	A
Repetitive Peak Surge Reverse Power	P <sub>RRSM</sub>	Pulse width 10 μs, T <sub>j</sub> =25°C	330	W
Dielectric Strength	V <sub>dis</sub>	Terminals to case, AC 1 minute	1.5	kV
Mounting Torque	TOR	(Recommended torque: 0.3N·m)	0.5	N·m

#### ● Electrical Characteristics (If not specified T<sub>c</sub> =25°C)

Item	Symbol	Conditions	Ratings	Unit
Forward Voltage	V <sub>F</sub>	I <sub>F</sub> =5A, Pulse measurement	Max 0.75	V
Reverse Current	I <sub>R</sub>	V <sub>R</sub> =V <sub>RM</sub> , Pulse measurement	Max 3.0	mA
Junction Capacitance	C <sub>j</sub>	f=1MHz, V <sub>R</sub> =10V	Typ 185	pF
Thermal Resistance	θ <sub>jc</sub>	junction to case	Max 4.5	°C/W
	θ <sub>jf</sub>	junction to heatsink	Max 6.0	

# D5S9M

## Forward Voltage

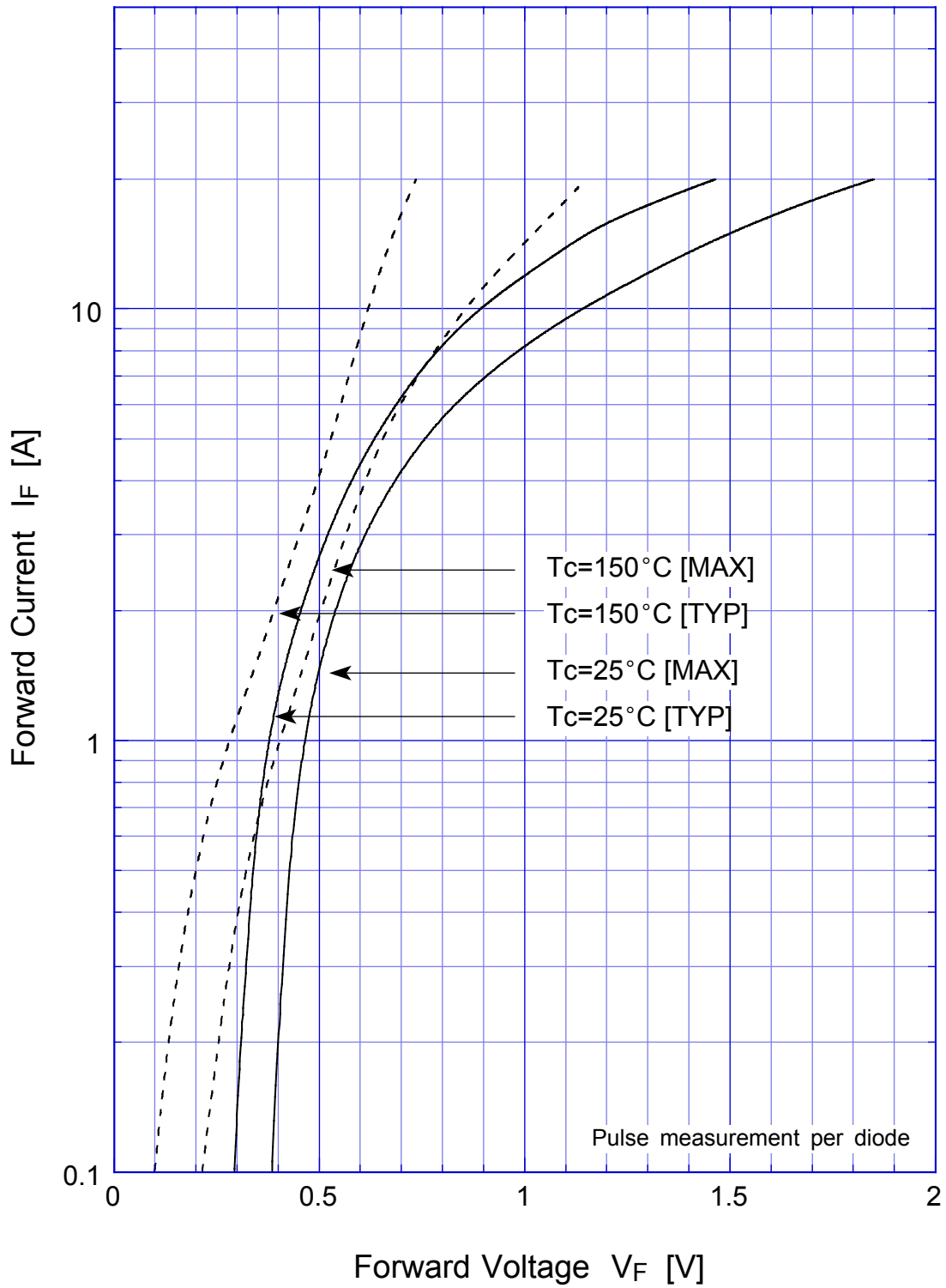

# D5S9M

## Junction Capacitance

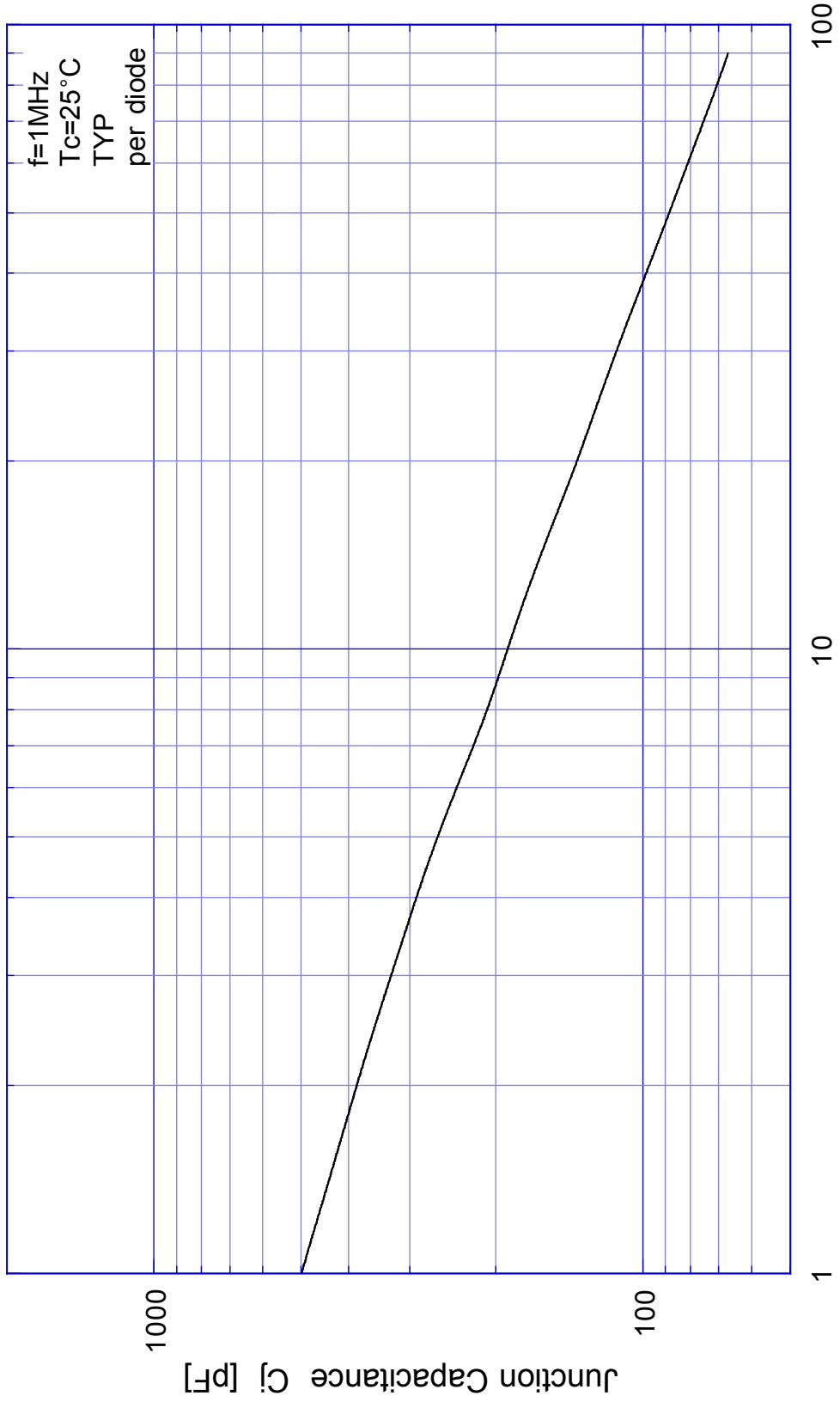

# D5S9M

## Reverse Current

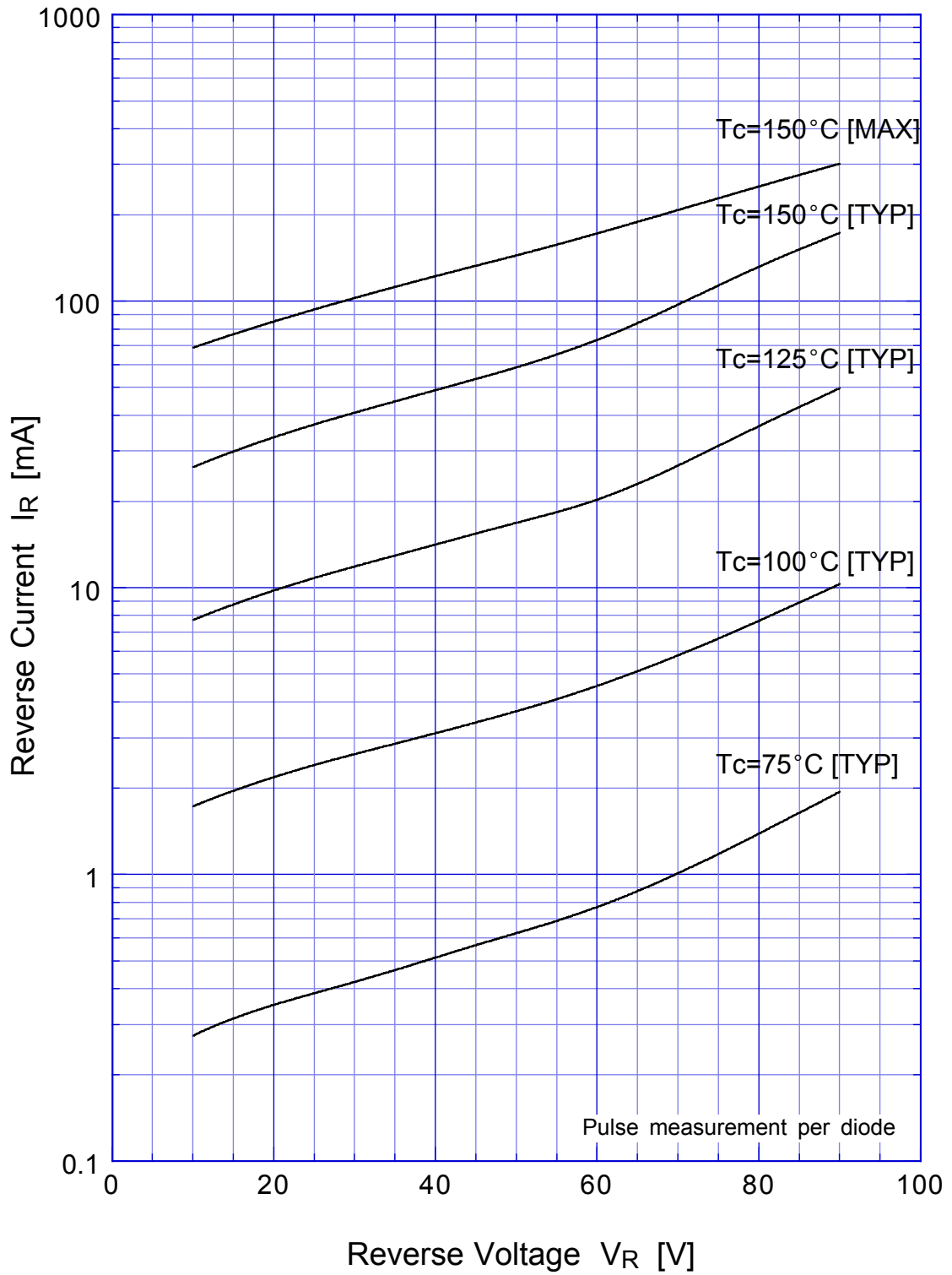

# D5S9M

## Reverse Power Dissipation

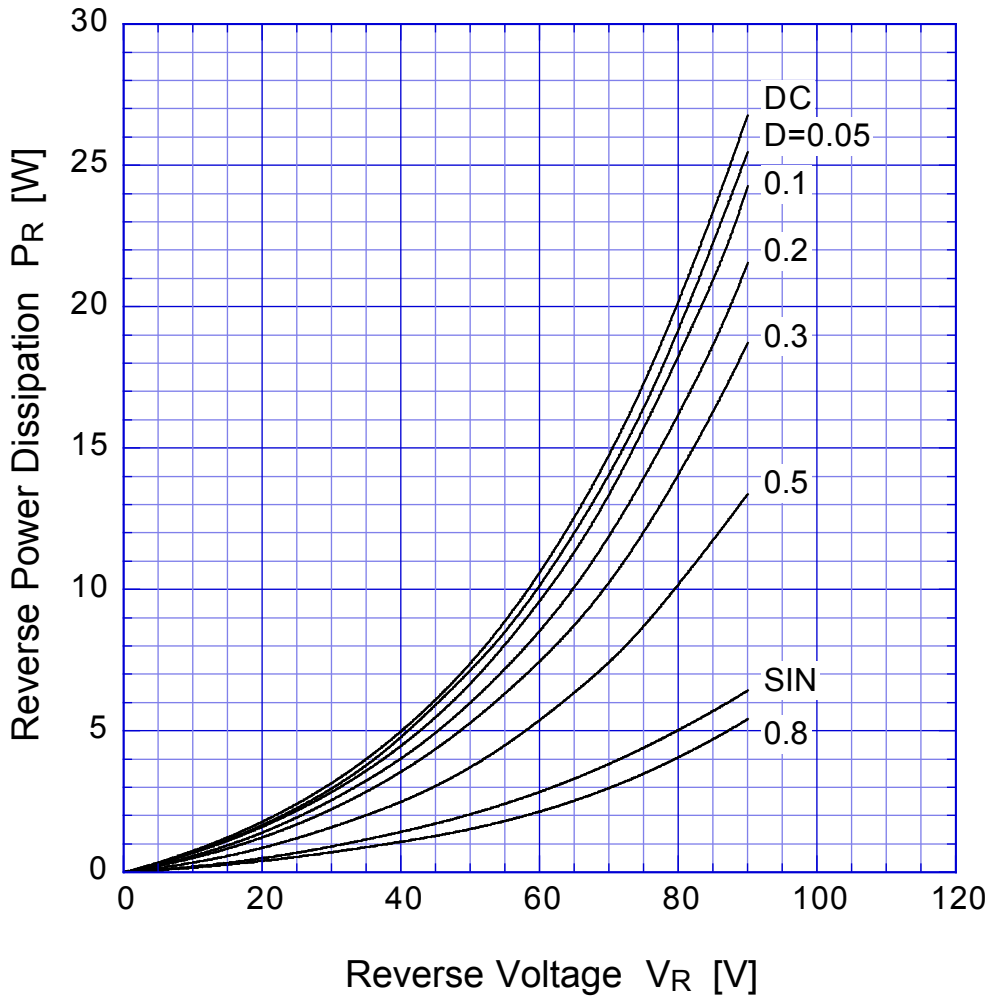

$T_j = 150^\circ\text{C}$

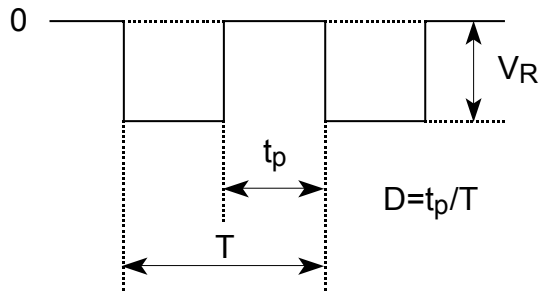

# D5S9M

## Forward Power Dissipation

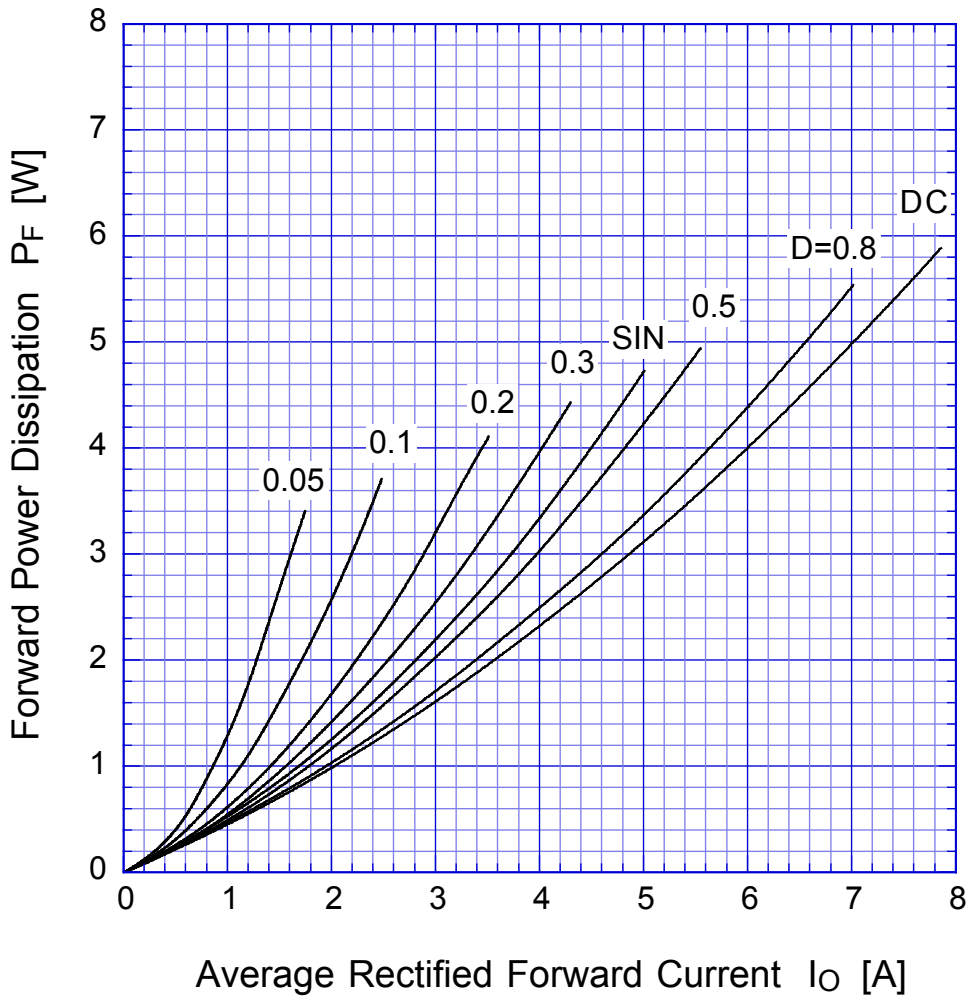

$T_j = 150^\circ\text{C}$

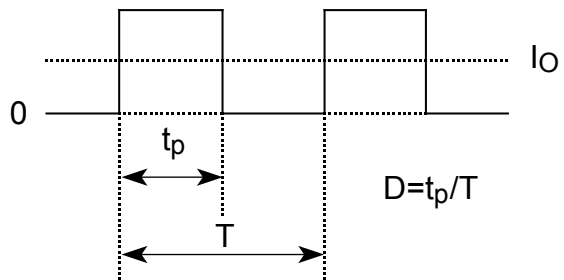

# D5S9M

# Derating Curve

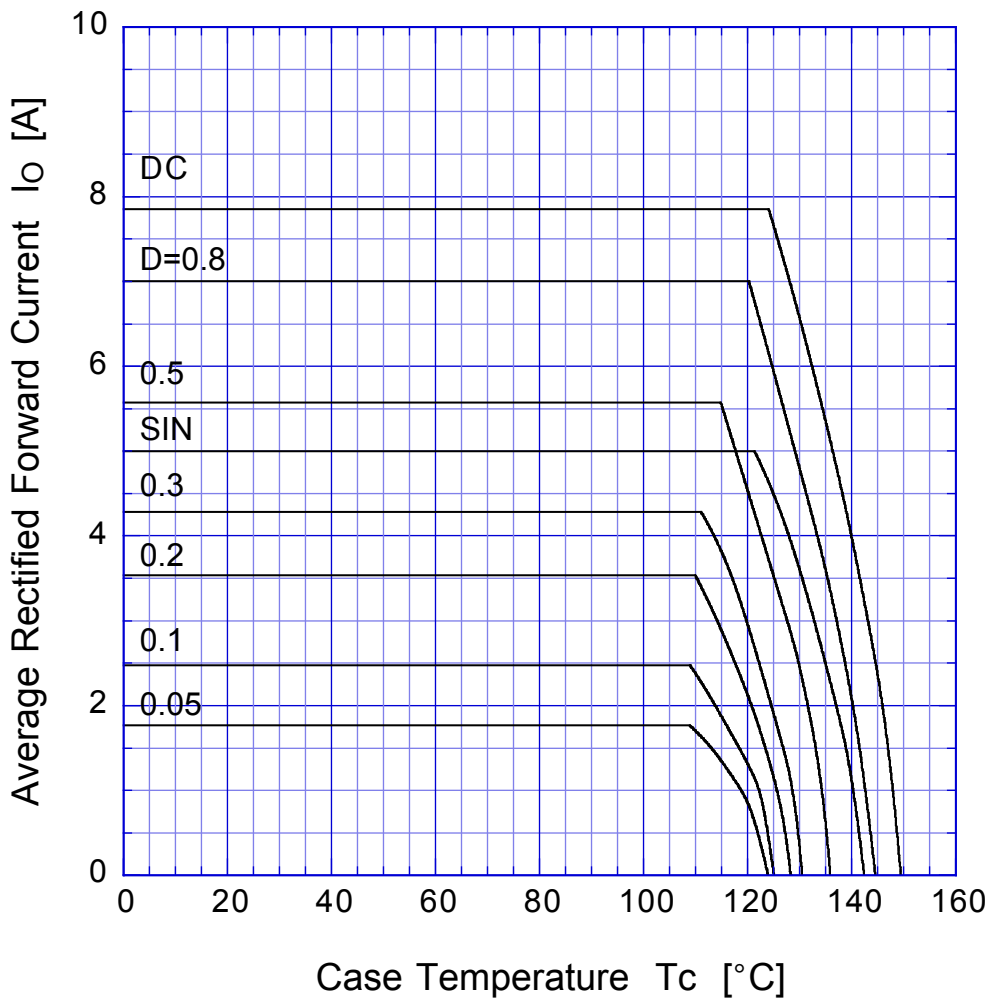

$V_R = 45V$



# D5S9M

## Peak Surge Forward Capability

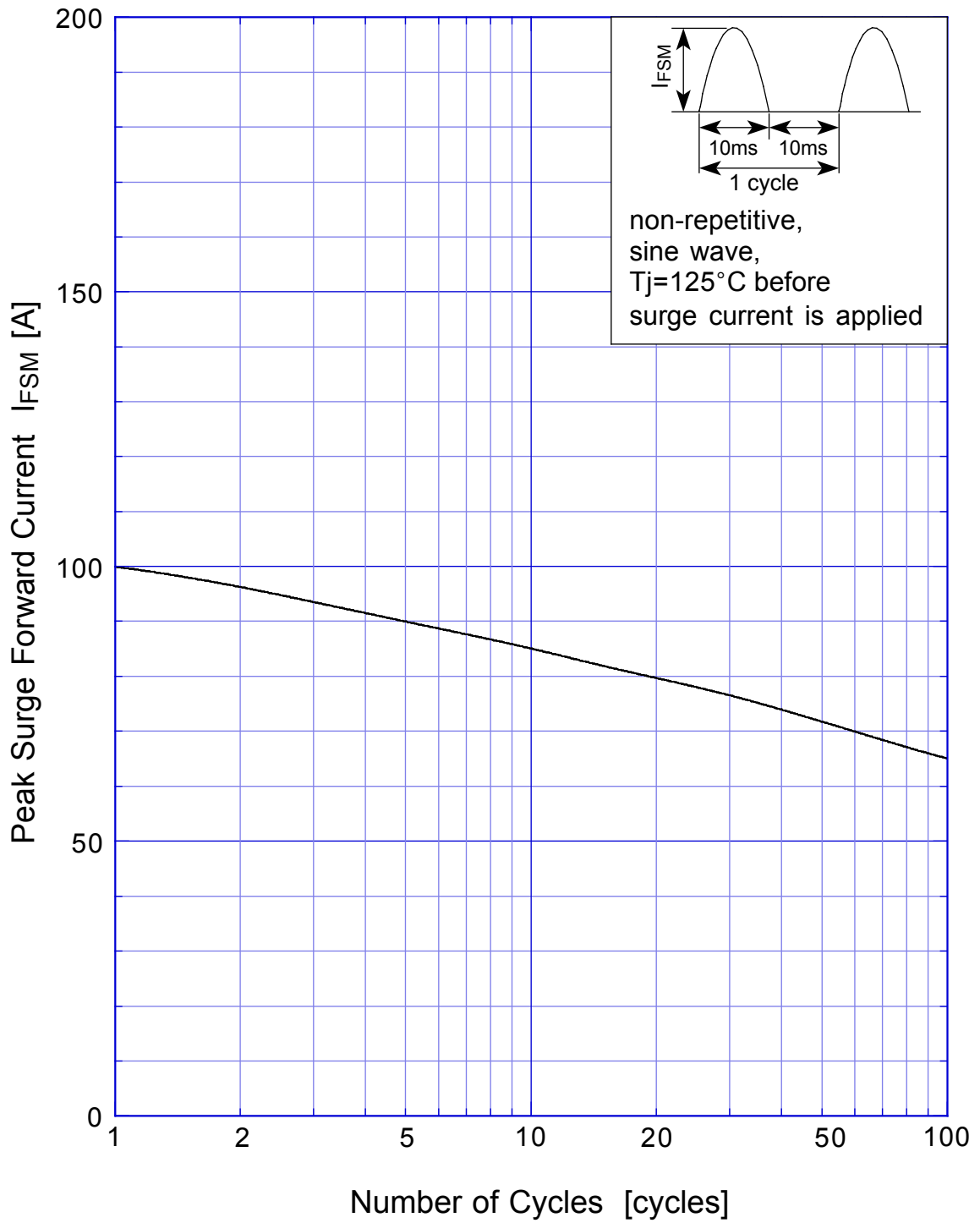



# SBD Repetitive Surge Reverse Power Derating Curve



# SBD

## Repetitive Surge Reverse Power Capability

