

Netz-Dioden-Modul  
Rectifier Diode Module**DD350N**

DD350N

DD350N..K..-K

**Elektrische Eigenschaften / Electrical properties**

Höchstzulässige Werte / Maximum rated values

Periodische Spitzensperrspannung repetitive peak reverse voltages	$T_{vj} = -40^{\circ}\text{C} \dots T_{vj\text{ max}}$	$V_{RRM}$	1200 1600	1400 1800	V V
Stoßspitzensperrspannung non-repetitive peak reverse voltage	$T_{vj} = +25^{\circ}\text{C} \dots T_{vj\text{ max}}$	$V_{RSM}$	1300 1700	1500 1900	V V
Durchlaßstrom-Grenzeffektivwert maximum RMS on-state current		$I_{FRMSM}$		550	A
Dauergrenzstrom average on-state current	$T_C = 100^{\circ}\text{C}$	$I_{FAVM}$		350	A
Stoßstrom-Grenzwert surge current	$T_{vj} = 25^{\circ}\text{C}, t_p = 10\text{ ms}$ $T_{vj} = T_{vj\text{ max}}, t_p = 10\text{ ms}$	$I_{FSM}$		13.000 11.000	A A
Grenzlastintegral $I^2t$ -value	$T_{vj} = 25^{\circ}\text{C}, t_p = 10\text{ ms}$ $T_{vj} = T_{vj\text{ max}}, t_p = 10\text{ ms}$	$I^2t$		845.000 605.000	$\text{A}^2\text{s}$ $\text{A}^2\text{s}$

## Charakteristische Werte / Characteristic values

Durchlaßspannung on-state voltage	$T_{vj} = T_{vj\text{ max}}, i_F = 1000\text{ A}$	$v_F$	max.	1,28	V
Schleusenspannung threshold voltage	$T_{vj} = T_{vj\text{ max}}$	$V_{(TO)}$		0,75	V
Ersatzwiderstand slope resistance	$T_{vj} = T_{vj\text{ max}}$	$r_T$		0,4	$\text{m}\Omega$
Sperrstrom reverse current	$T_{vj} = T_{vj\text{ max}}, V_R = V_{RRM}$	$i_R$	max.	30	$\text{mA}$
Isolations-Prüfspannung insulation test voltage	RMS, $f = 50\text{ Hz}, t = 1\text{ sec}$ RMS, $f = 50\text{ Hz}, t = 1\text{ min}$	$V_{ISOL}$		3,6 3,0	$\text{kV}$ $\text{kV}$

**Thermische Eigenschaften / Thermal properties**

Innerer Wärmewiderstand thermal resistance, junction to case	pro Modul / per Module, $\Theta = 180^{\circ}\text{ sin}$ pro Zweig / per arm, $\Theta = 180^{\circ}\text{ sin}$ pro Modul / per Module, DC pro Zweig / per arm, DC	$R_{thJC}$	max.	0,065 0,130 0,062 0,124	$^{\circ}\text{C/W}$ $^{\circ}\text{C/W}$ $^{\circ}\text{C/W}$ $^{\circ}\text{C/W}$
Übergangs-Wärmewiderstand thermal resistance, case to heatsink	pro Modul / per Module pro Zweig / per arm	$R_{thCH}$	max.	0,02 0,04	$^{\circ}\text{C/W}$ $^{\circ}\text{C/W}$
Höchstzulässige Sperrschichttemperatur maximum junction temperature		$T_{vj\text{ max}}$		150	$^{\circ}\text{C}$
Betriebstemperatur operating temperature		$T_{c\text{ op}}$		- 40...+150	$^{\circ}\text{C}$
Lagertemperatur storage temperature		$T_{stg}$		- 40...+150	$^{\circ}\text{C}$

prepared by:	C. Drilling	date of publication:	06.05.03
approved by:	M. Leifeld	revision:	1



**Netz-Dioden-Modul**  
**Rectifier Diode Module**

**DD350N**

**Mechanische Eigenschaften / Mechanical properties**

Gehäuse, siehe Anlage case, see annex			Seite 3 page 3	
Si-Element mit Druckkontakt Si-pellet with pressure contact				
Innere Isolation internal insulation			AIN	
Anzugsdrehmoment für mechanische Anschlüsse mounting torque	Toleranz $\pm 15\%$	M1	5	Nm
Anzugsdrehmoment für elektrische Anschlüsse terminal connection torque	Toleranz $\pm 10\%$	M2	12	Nm
Gewicht weight		G	typ. 800	g
Kriechstrecke creepage distance			17	mm
Schwingfestigkeit vibration resistance	f = 50 Hz		50	m/s <sup>2</sup>
	file-No.		E 83336	

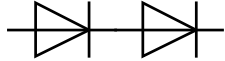

**Netz-Dioden-Modul  
Rectifier Diode Module**

**DD350N**

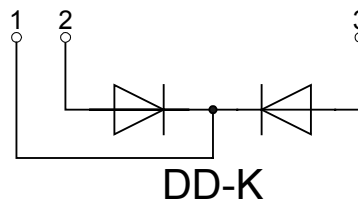
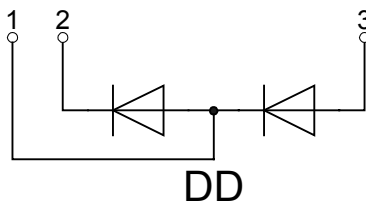
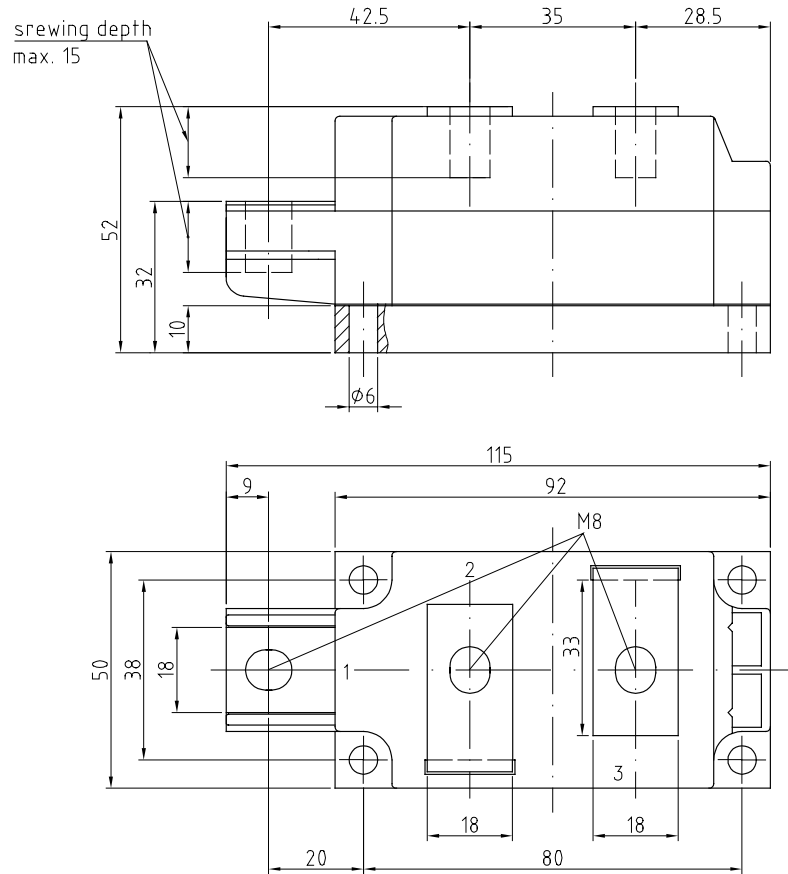

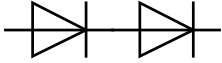
Netz-Dioden-Modul  
Rectifier Diode Module**DD350N**
**Analytische Elemente des transienten Wärmewiderstandes  $Z_{thJC}$  für DC**  
**Analytical elements of transient thermal impedance  $Z_{thJC}$  for DC**

Pos. n	1	2	3	4	5	6	7
$R_{thn}$ [°C/W]	0,0031	0,0097	0,0257	0,0429	0,0426		
$T_n$ [s]	0,0009	0,008	0,11	0,61	3,06		

Analytische Funktion / Analytical function:

$$Z_{thJC} = \sum_{n=1}^{n_{max}} R_{thn} \left( 1 - e^{-\frac{t}{\tau_n}} \right)$$

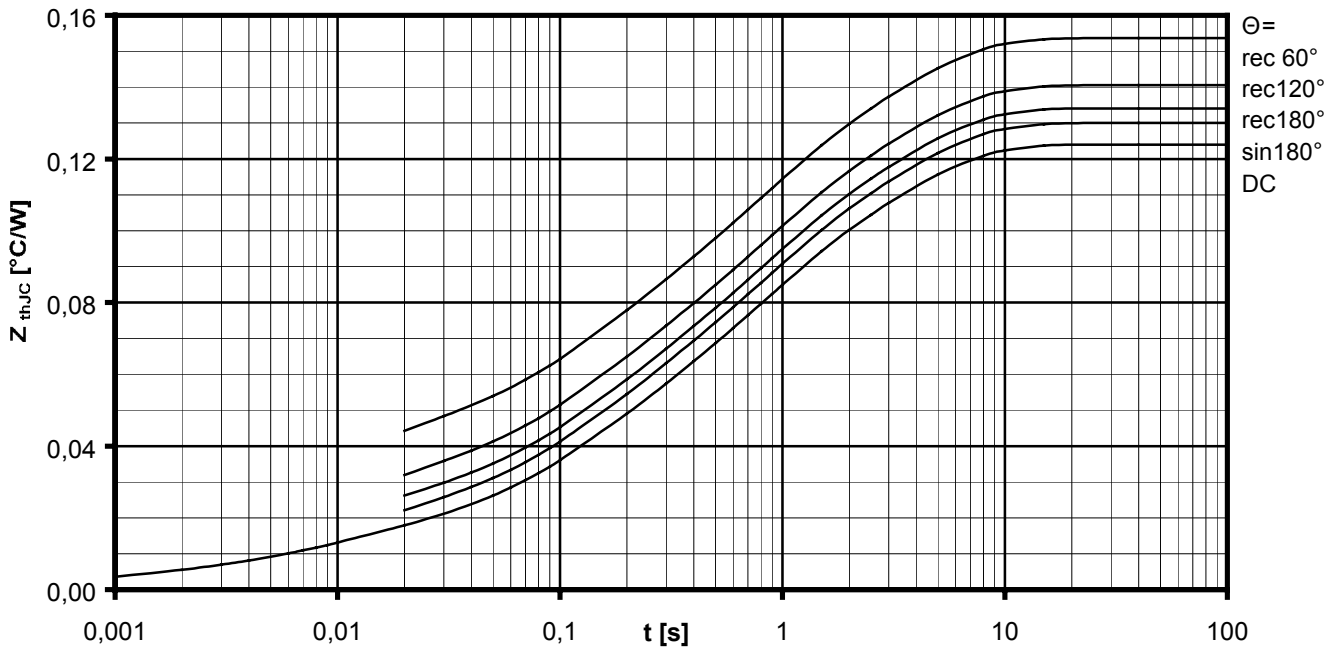
 Transienter innerer Wärmewiderstand je Zweig / Transient thermal impedance per arm  $Z_{thJC} = f(t)$ 

 Parameter: Stromflußwinkel  $\Theta$  / Current conduction angle  $\Theta$

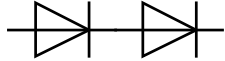
Netz-Dioden-Modul  
Rectifier Diode Module**DD350N**

Natürliche Kühlung / Natural cooling  
3 Module pro Kühler / 3 modules per heatsink  
Kühler / Heatsink type: KM17 (60W)

**Analytische Elemente des transienten Wärmewiderstandes  $Z_{thCA}$**   
**Analytical elements of transient thermal impedance  $Z_{thCA}$**

Pos. n	1	2	3	4	5	6	7
$R_{thn}$ [°C/W]	0,0205	0,07905	1,535				
$T_n$ [s]	2,04	36,4	1340				

Verstärkte Kühlung / Forced cooling  
3 Module pro Kühler / 3 modules per heatsink  
Kühler / Heatsink type: KM17 (Papst 4650)

**Analytische Elemente des transienten Wärmewiderstandes  $Z_{thCA}$**   
**Analytical elements of transient thermal impedance  $Z_{thCA}$**

Pos. n	1	2	3	4	5	6	7
$R_{thn}$ [°C/W]	0,015	0,08	0,475				
$T_n$ [s]	4,11	40,4	458				

Analytische Funktion / Analytical function:

$$Z_{thCA} = \sum_{n=1}^{n_{max}} R_{thn} \left( 1 - e^{-\frac{t}{T_n}} \right)$$



Netz-Dioden-Modul  
Rectifier Diode Module

**DD350N**

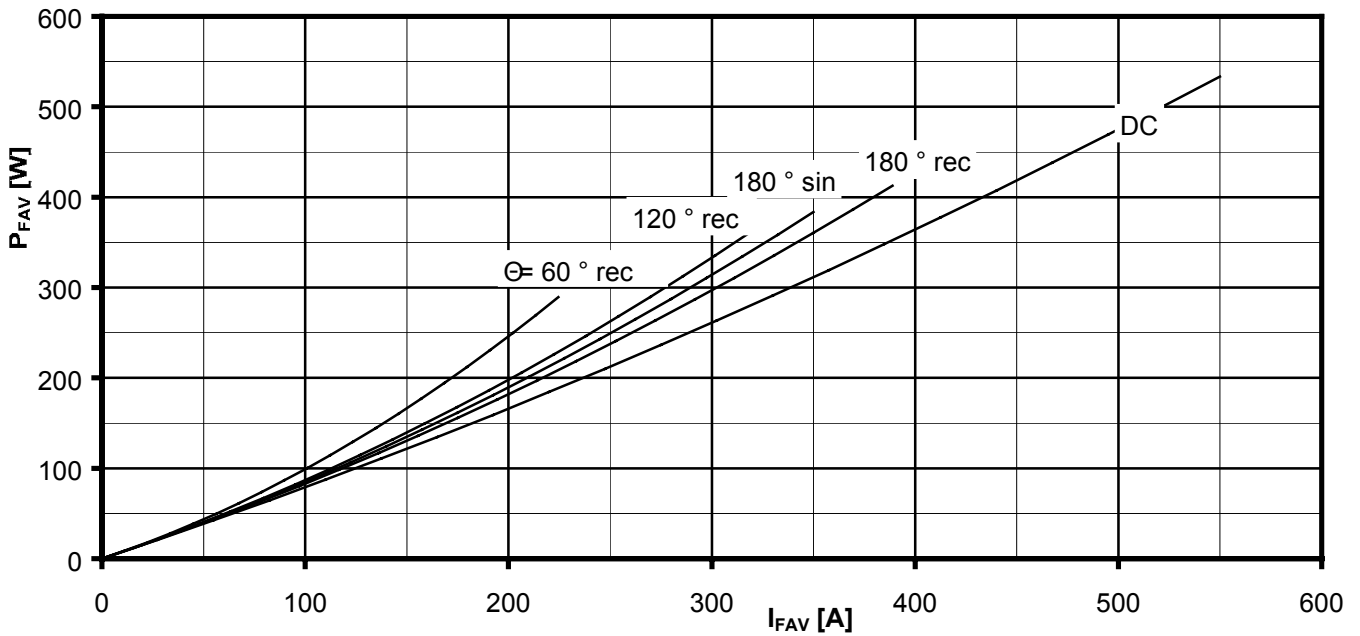

Durchlassverlustleistung je Zweig / On-state power loss per arm  $P_{FAV} = f(I_{FAV})$

Parameter: Stromflußwinkel / Current conduction angle  $\Theta$

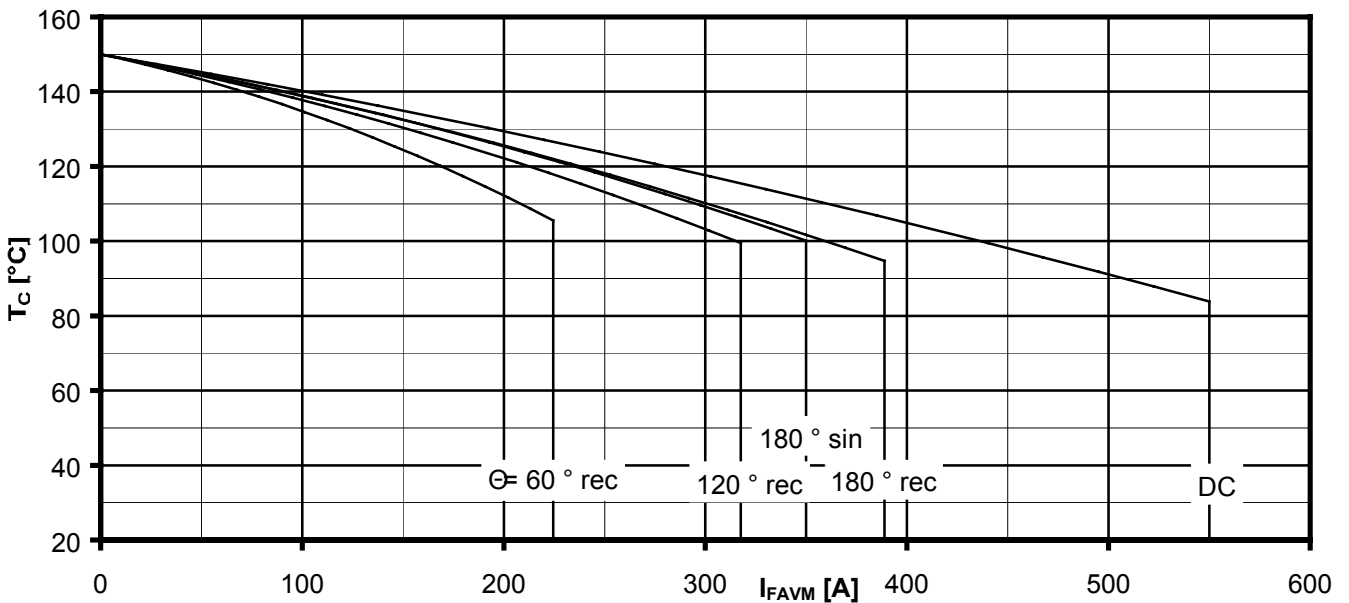

Höchstzulässige Gehäusetemperatur / Maximum allowable case temperature  $T_C = f(I_{FAVM})$

Strombelastung je Zweig / Current load per arm

Berechnungsgrundlage  $P_{TAV}$   
Calculation base  $P_{TAV}$

Parameter: Stromflußwinkel  $\Theta$  / Current conduction angle  $\Theta$



**Netz-Dioden-Modul  
Rectifier Diode Module**

**DD350N**

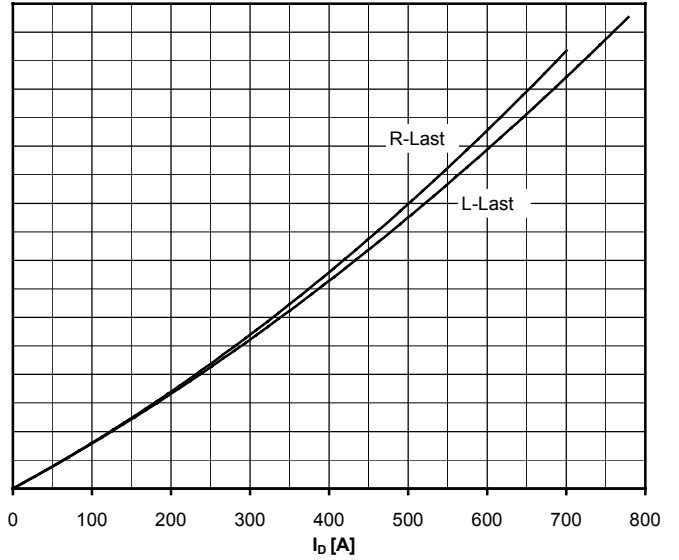
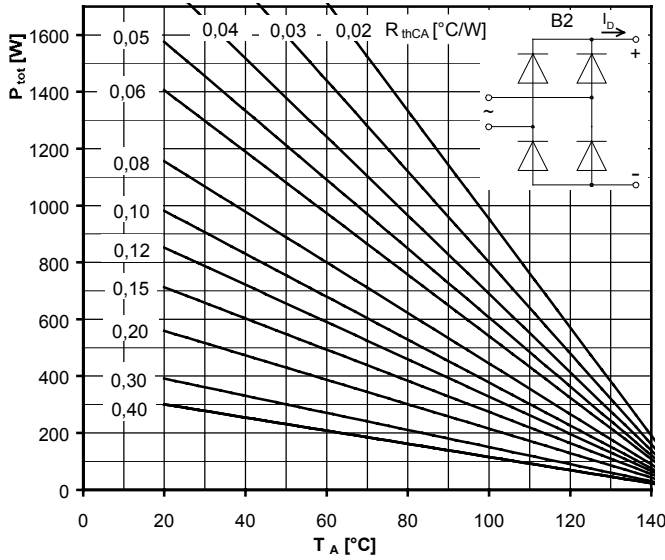

**Höchstzulässiger Ausgangsstrom / Maximum rated output current  $I_b$**

B2- Zweipuls-Brückenschaltung / Two-pulse bridge circuit

Gesamtverlustleistung der Schaltung / Total power dissipation at circuit  $P_{tot}$

Parameter:

Wärmewiderstand zwischen den Gehäusen und Umgebung / Thermal resistance cases to ambient  $R_{thCA}$

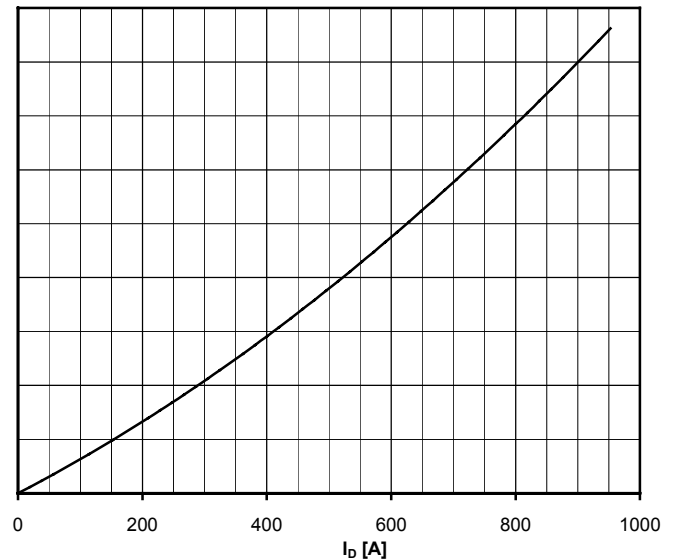
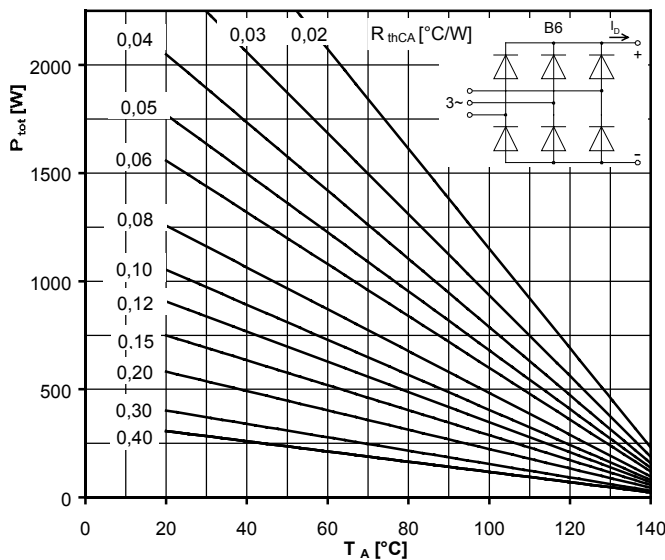

**Höchstzulässiger Ausgangsstrom / Maximum rated output current  $I_b$**

B6- Sechspuls-Brückenschaltung / Six-pulse bridge circuit

Gesamtverlustleistung der Schaltung / Total power dissipation at circuit  $P_{tot}$

Parameter:

Wärmewiderstand zwischen den Gehäusen und Umgebung / Thermal resistance cases to ambient  $R_{thCA}$



Netz-Dioden-Modul  
Rectifier Diode Module

**DD350N**

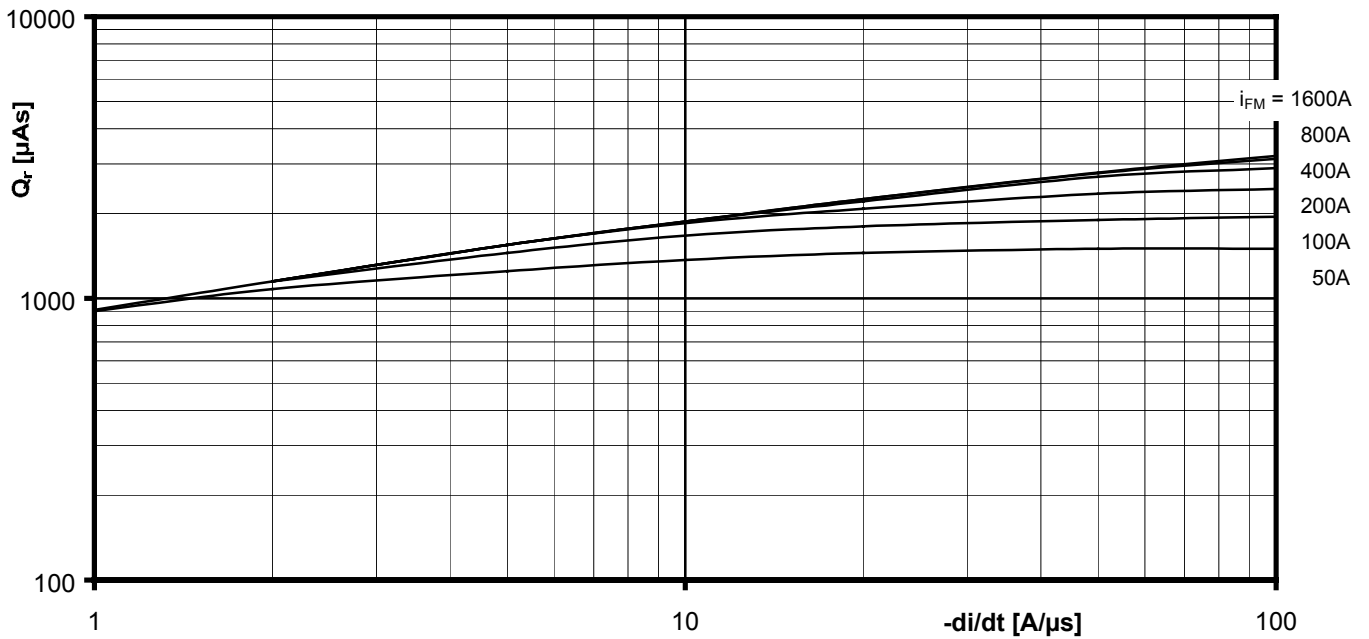

Sperrverzögerungsladung / Recovered charge  $Q_r = f(-di/dt)$

$$T_{vj} = T_{vjmax}, V_R \leq 0,5 V_{RRM}, V_{RM} = 0,8 V_{RRM}$$

Parameter: Durchlaßstrom / On-state current  $i_{FM}$

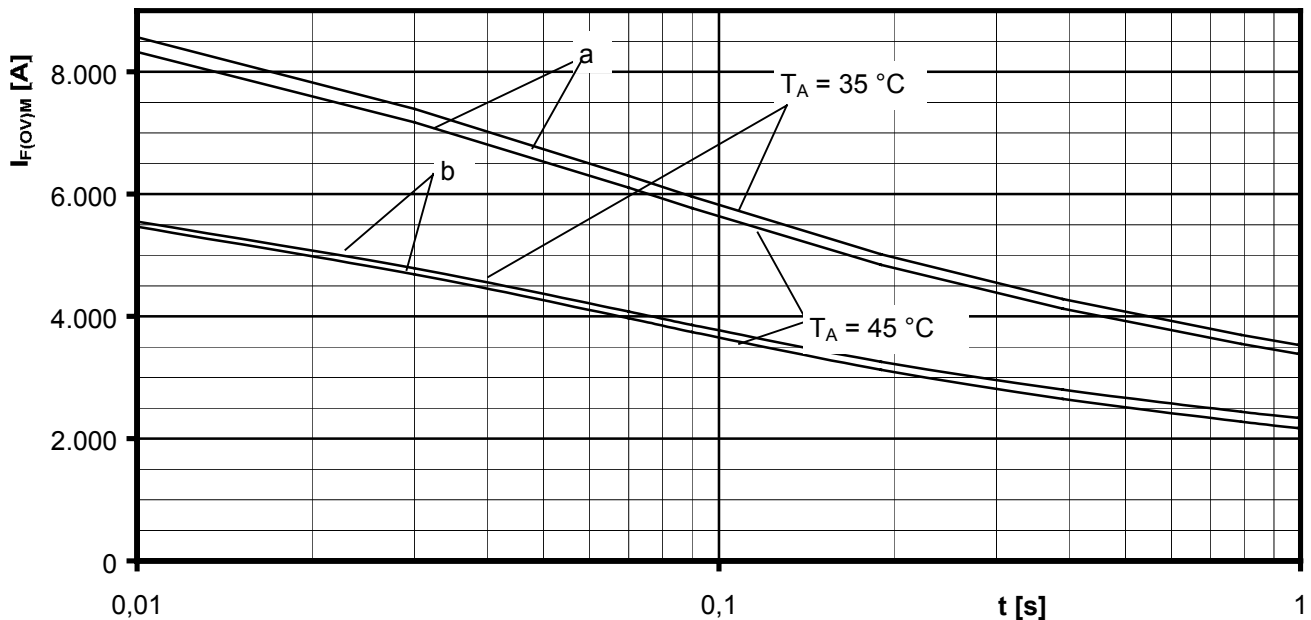

Grenzstrom je Zweig / Maximum overload on-state current per arm  $I_{F(OV)M} = f(t), V_{RM} = 0,8 V_{RRM}$

a: Leerlauf / No-load conditions

b: Vorlaststrom je Zweig / Pre-load current per arm  $I_{FAV(vor)} = I_{FAVM}$

$T_a = 35^\circ\text{C}$ , verstärkte Luftkühlung / Forced air cooling    Kühlkörper / Heatsink type: KM17 (Papst 4650)

$T_a = 45^\circ\text{C}$ , natürliche Luftkühlung / Natural air cooling    Kühlkörper / Heatsink type: KM17 (60W)





Netz-Dioden-Modul  
Rectifier Diode Module

**DD350N**

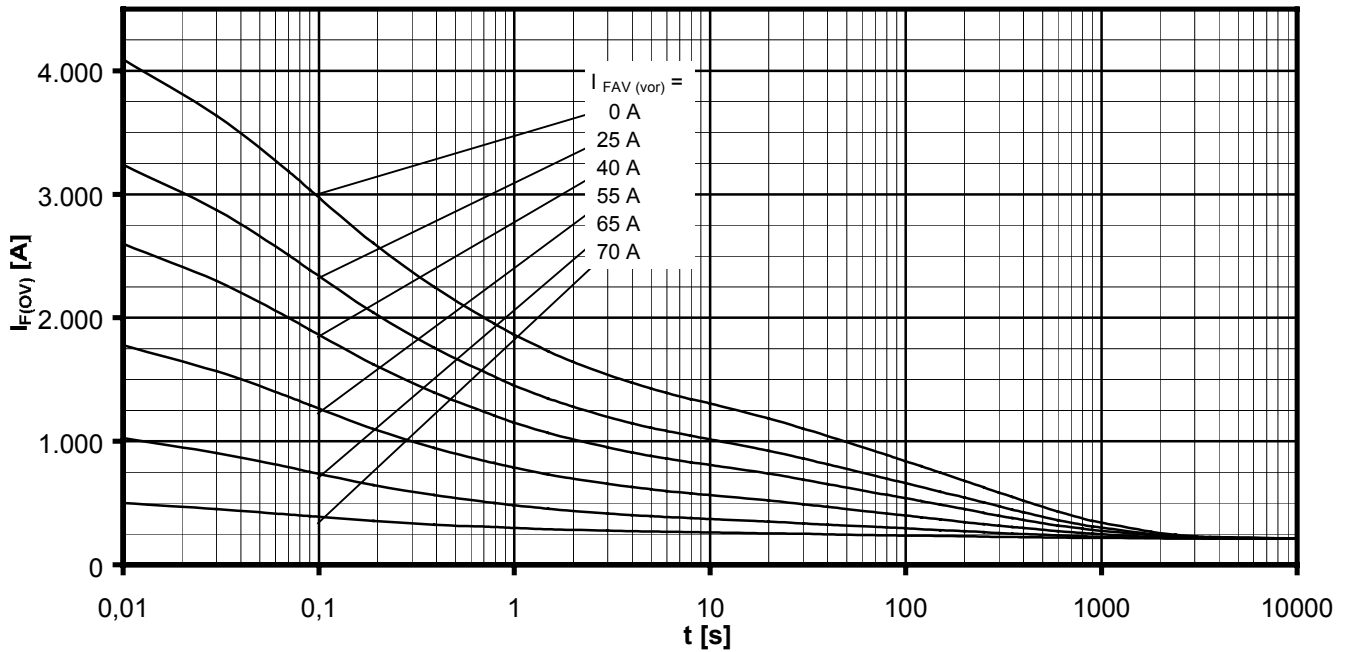

Überstrom je Zweig / Overload on-state current  $I_{F(ov)}$

B6- Sechspuls-Brückenschaltung, 120° Rechteck / Six-pulse bridge circuit, 120° rectangular

Kühlkörper / Heatsink type KM17 (60W) Natürliche Kühlung bei / Natural cooling at  $T_A = 45^\circ\text{C}$

Parameter: Vorlaststrom je Zweig / Pre-load current per arm  $I_{FAV(vor)}$

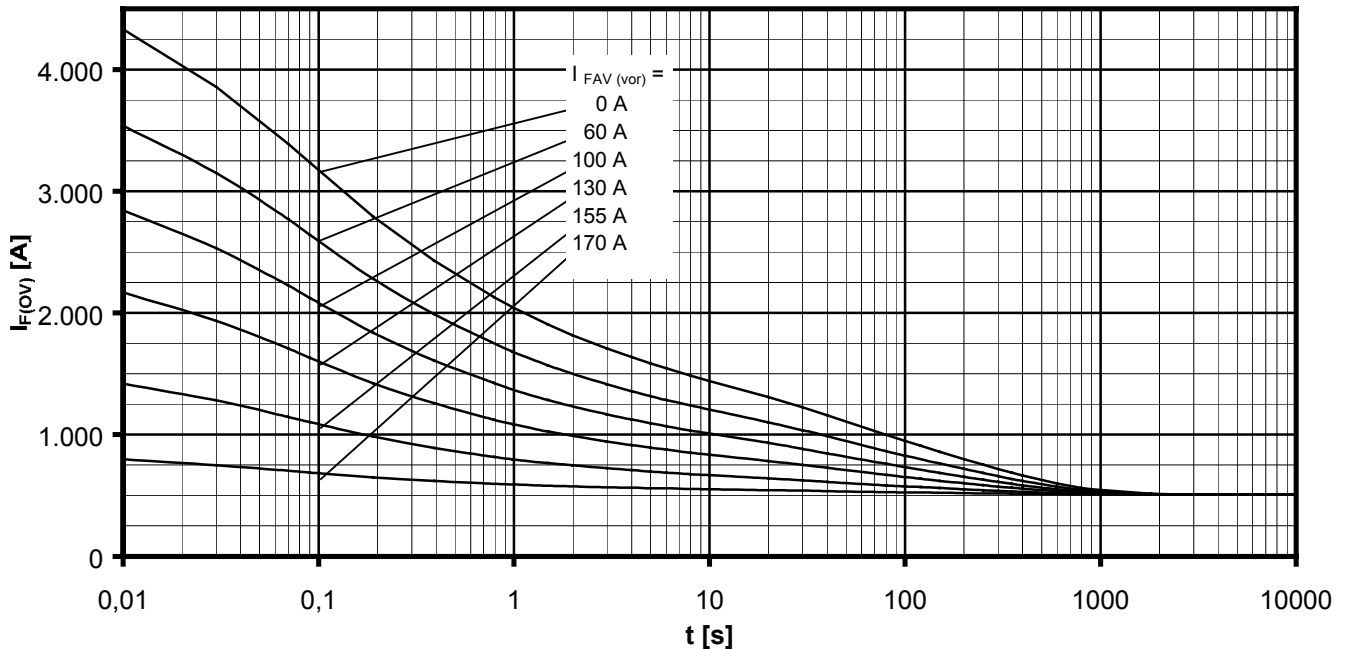

Überstrom je Zweig / Overload on-state current  $I_{F(ov)}$

B6- Sechspuls-Brückenschaltung, 120° Rechteck / Six-pulse bridge circuit 120° rectangular

Kühlkörper / Heatsink type KM17 (Papst 4650) Verstärkte Kühlung bei / Forced cooling at  $T_A = 35^\circ\text{C}$

Parameter: Vorlaststrom je Zweig / Pre-load current per arm  $I_{FAV(vor)}$

## **Terms & Conditions of Usage**

### **Attention**

The present product data is exclusively subscribed to technically experienced staff. This Data Sheet is describing the specification of the products for which a warranty is granted exclusively pursuant the terms and conditions of the supply agreement. There will be no guarantee of any kind for the product and its specifications. Changes to the Data Sheet are reserved.

You and your technical departments will have to evaluate the suitability of the product for the intended application and the completeness of the product data with respect to such application. Should you require product information in excess of the data given in the Data Sheet, please contact your local Sales Office via "[www.eupec.com / sales & contact](http://www.eupec.com / sales & contact)".

### **Warning**

Due to technical requirements the products may contain dangerous substances. For information on the types in question please contact your local Sales Office via "[www.eupec.com / sales & contact](http://www.eupec.com / sales & contact)".