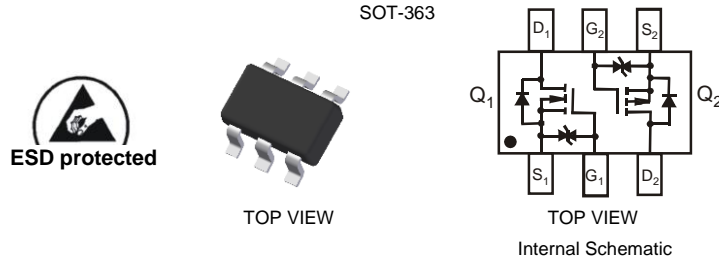

COMPLEMENTARY PAIR ENHANCEMENT MODE FIELD EFFECT TRANSISTOR
NEW PRODUCT
Features

- Low On-Resistance
- Low Gate Threshold Voltage $V_{GS(th)} < 1V$
- Low Input Capacitance
- Fast Switching Speed
- Low Input/Output Leakage
- Complementary Pair MOSFET
- Ultra-Small Surface Mount Package
- **ESD Protected Gate**
- **Totally Lead-Free & Fully RoHS Compliant (Notes 2 & 3)**
- **Halogen and Antimony Free. "Green" Device (Note 4)**
- **For automotive applications requiring specific change control (i.e. parts qualified to AEC-Q100/101/200, PPAP capable, and manufactured in IATF 16949 certified facilities), please [contact us](https://www.diodes.com/quality/product-definitions/) or your local Diodes representative. <https://www.diodes.com/quality/product-definitions/>**

Mechanical Data

- Case: SOT-363
- Case Material: Molded Plastic. UL Flammability Classification Rating 94V-0
- Moisture Sensitivity: Level 1 per J-STD-020C
- Terminals: Solderable per MIL-STD-202, Method 208
- Lead Free Plating (Matte Tin Finish annealed over Alloy 42 leadframe).
- Terminal Connections: See Diagram
- Marking Information: See Page 7
- Ordering & Date Code Information: See Page 7
- Weight: 0.006 grams (approximate)

Maximum Ratings N-CHANNEL – Q₁ @ $T_A = 25^\circ C$ unless otherwise specified

Characteristic	Symbol	Value	Unit
Drain Source Voltage	V_{DSS}	20	V
Gate-Source Voltage	V_{GSS}	± 8	V
Drain Current (Note 1)		$T_A = 25^\circ C$	540
		$T_A = 85^\circ C$	390

Maximum Ratings P-CHANNEL – Q₂ @ $T_A = 25^\circ C$ unless otherwise specified

Characteristic	Symbol	Value	Unit
Drain Source Voltage	V_{DSS}	-20	V
Gate-Source Voltage	V_{GSS}	± 8	V
Drain Current (Note 1)		$T_A = 25^\circ C$	-430
		$T_A = 85^\circ C$	-310

Thermal Characteristics – Total Device @ $T_A = 25^\circ C$ unless otherwise specified

Characteristic	Symbol	Value	Unit
Power Dissipation (Note 1)	P_d	250	mW
Thermal Resistance, Junction to Ambient	$R_{\theta JA}$	500	$^\circ C/W$
Operating and Storage Temperature Range	T_j, T_{STG}	-65 to +150	$^\circ C$

- Notes:
1. Device mounted on FR-4 PCB.
 2. No purposely added lead. Fully EU Directive 2002/95/EC (RoHS), 2011/65/EU (RoHS 2) & 2015/863/EU (RoHS 3) compliant.
 3. See <https://www.diodes.com/quality/lead-free/> for more information about Diodes Incorporated's definitions of Halogen- and Antimony-free, "Green" and Lead-free.
 4. Halogen- and Antimony-free "Green" products are defined as those which contain <900ppm bromine, <900ppm chlorine (<1500ppm total Br + Cl) and <1000ppm antimony compounds.

Electrical Characteristics N-CHANNEL – Q₁ @T_A = 25°C unless otherwise specified

Characteristic	Symbol	Min	Typ	Max	Unit	Test Condition
OFF CHARACTERISTICS (Note 5)						
Drain-Source Breakdown Voltage	BV _{DSS}	20	—	—	V	V _{GS} = 0V, I _D = 10μA
Zero Gate Voltage Drain Current	I _{DSS}	—	—	1	μA	V _{DS} = 16V, V _{GS} = 0V
Gate-Source Leakage	I _{GSS}	—	—	± 1	μA	V _{GS} = ±4.5V, V _{DS} = 0V
ON CHARACTERISTICS (Note 5)						
Gate Threshold Voltage	V _{GS(th)}	0.5	—	1.0	V	V _{DS} = V _{GS} , I _D = 250μA
Static Drain-Source On-Resistance	R _{DS(ON)}	—	0.4	0.55	Ω	V _{GS} = 4.5V, I _D = 540mA
		—	0.5	0.70		V _{GS} = 2.5V, I _D = 500mA
		—	0.7	0.90		V _{GS} = 1.8V, I _D = 350mA
Forward Transfer Admittance	Y _{fs}	200	—	—	mS	V _{DS} = 10V, I _D = 0.2A
Diode Forward Voltage (Note 5)	V _{SD}	0.5	—	1.2	V	V _{GS} = 0V, I _S = 115mA
DYNAMIC CHARACTERISTICS						
Input Capacitance	C _{iss}	—	—	150	pF	V _{DS} = 16V, V _{GS} = 0V f = 1.0MHz
Output Capacitance	C _{oss}	—	—	25	pF	
Reverse Transfer Capacitance	C _{rss}	—	—	20	pF	

Electrical Characteristics P-CHANNEL – Q₂ @T_A = 25°C unless otherwise specified

Characteristic	Symbol	Min	Typ	Max	Unit	Test Condition
OFF CHARACTERISTICS (Note 5)						
Drain-Source Breakdown Voltage	BV _{DSS}	-20	—	—	V	V _{GS} = 0V, I _D = -250μA
Zero Gate Voltage Drain Current	I _{DSS}	—	—	-1.0	μA	V _{DS} = -20V, V _{GS} = 0V
Gate-Source Leakage	I _{GSS}	—	—	± 1.0	μA	V _{GS} = ±4.5V, V _{DS} = 0V
ON CHARACTERISTICS (Note 5)						
Gate Threshold Voltage	V _{GS(th)}	-0.5	—	-1.0	V	V _{DS} = V _{GS} , I _D = -250μA
Static Drain-Source On-Resistance	R _{DS(ON)}	—	0.7	0.9	Ω	V _{GS} = -4.5V, I _D = -430mA
		—	1.1	1.4		V _{GS} = -2.5V, I _D = -300mA
		—	1.7	2.0		V _{GS} = -1.8V, I _D = -150mA
Forward Transfer Admittance	Y _{fs}	200	—	—	mS	V _{DS} = 10V, I _D = 0.2A
Diode Forward Voltage (Note 5)	V _{SD}	-0.5	—	-1.2	V	V _{GS} = 0V, I _S = -115mA
DYNAMIC CHARACTERISTICS						
Input Capacitance	C _{iss}	—	—	175	pF	V _{DS} = -16V, V _{GS} = 0V f = 1.0MHz
Output Capacitance	C _{oss}	—	—	30	pF	
Reverse Transfer Capacitance	C _{rss}	—	—	20	pF	

Notes: 5. Short duration pulse test used to minimize self-heating effect.

Q₁, N-CHANNEL

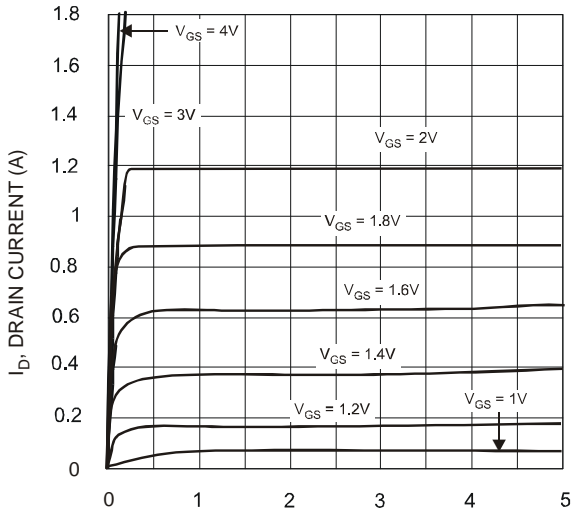

V_{DS} , DRAIN SOURCE VOLTAGE (V)
Fig. 1 Typical Output Characteristics

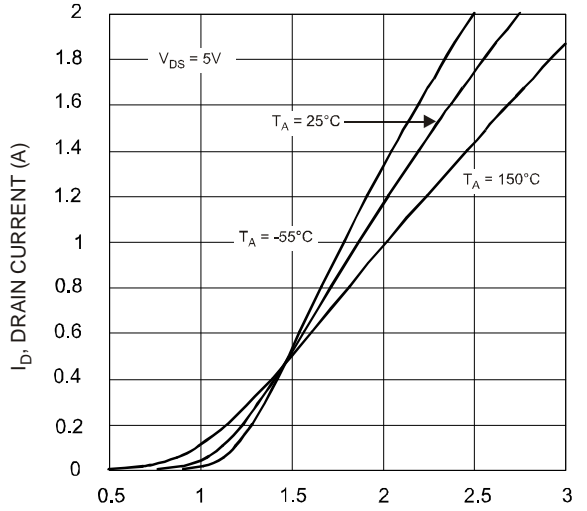

V_{GS} , GATE SOURCE VOLTAGE (V)
Fig. 2 Typical Transfer Characteristics

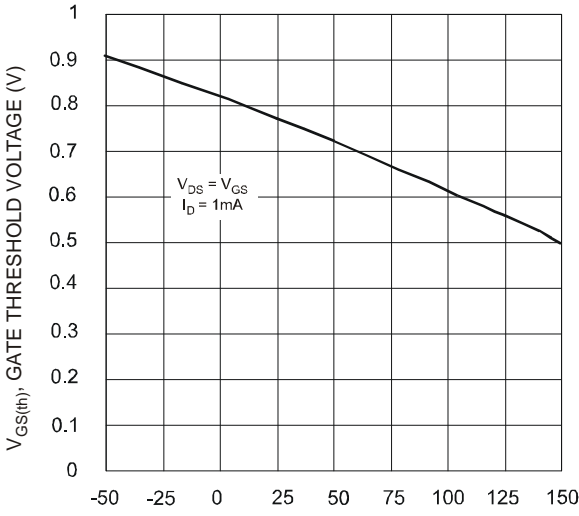

T_A , AMBIENT TEMPERATURE (°C)
Fig. 3 Gate Threshold Voltage vs. Ambient Temperature

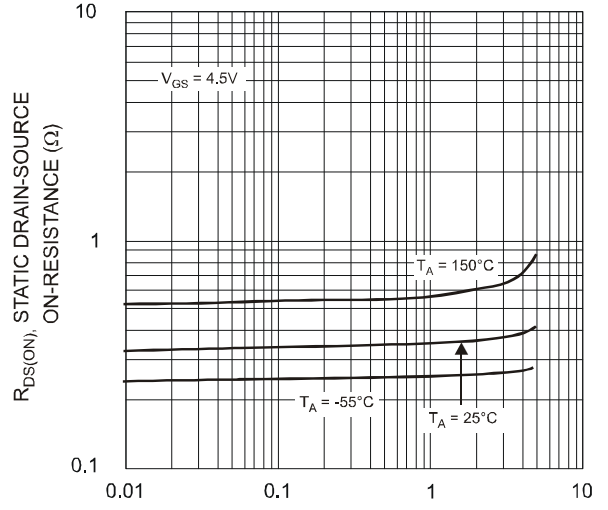

I_D , DRAIN CURRENT (A)
Fig. 4 Static Drain-Source On-Resistance vs. Drain Current

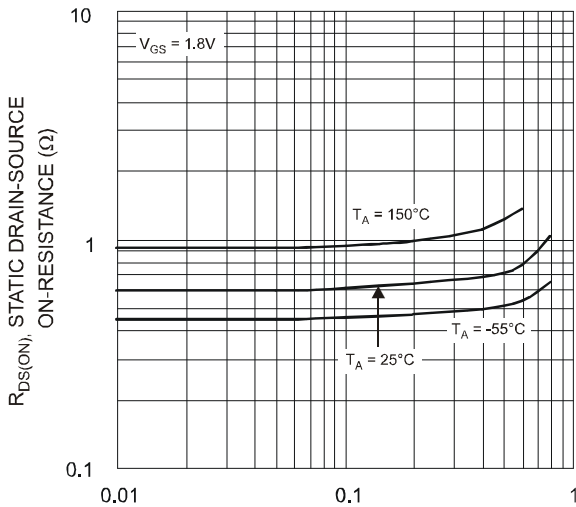

I_D , DRAIN CURRENT (A)
Fig. 5 Static Drain-Source On-Resistance vs. Drain Current

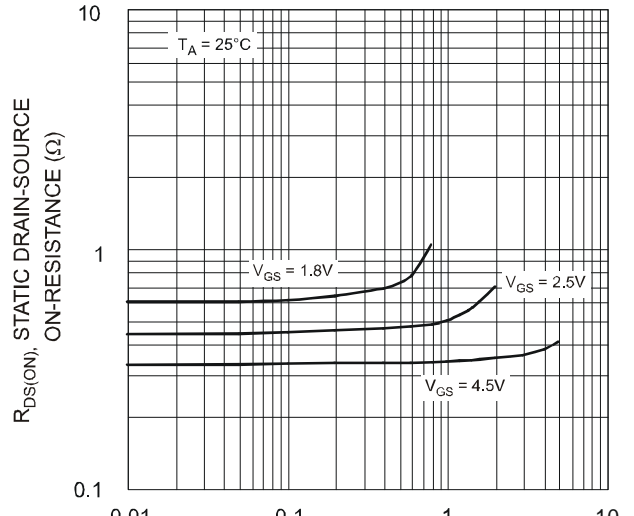

I_D , DRAIN-SOURCE CURRENT (A)
Fig. 6 Static Drain-Source On-Resistance vs. Drain-Source Current vs. Gate Source Voltage

Q₁, N-CHANNEL (continued)

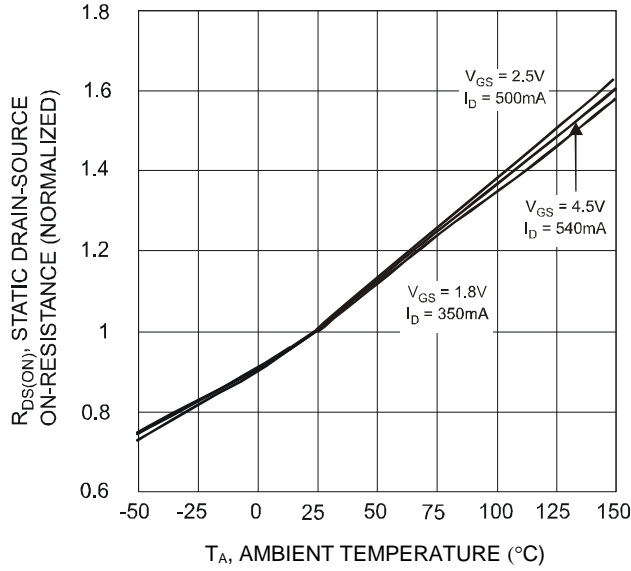

Fig. 7 Static Drain-Source On-State Resistance vs. Ambient Temperature

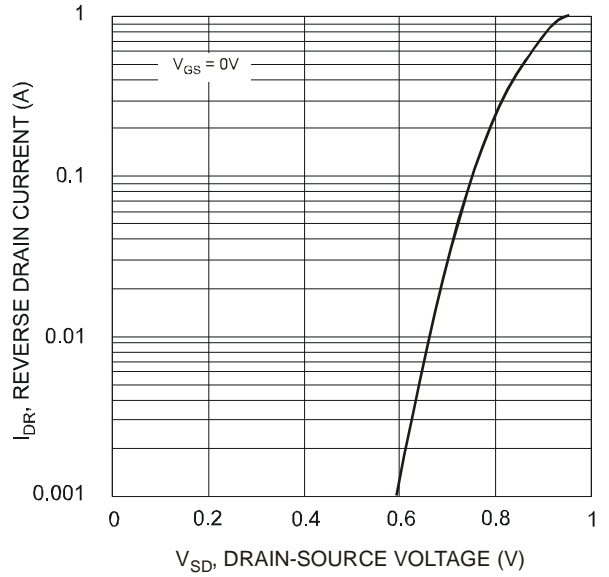

Fig. 8 Reverse Drain Current vs. Source-Drain Voltage

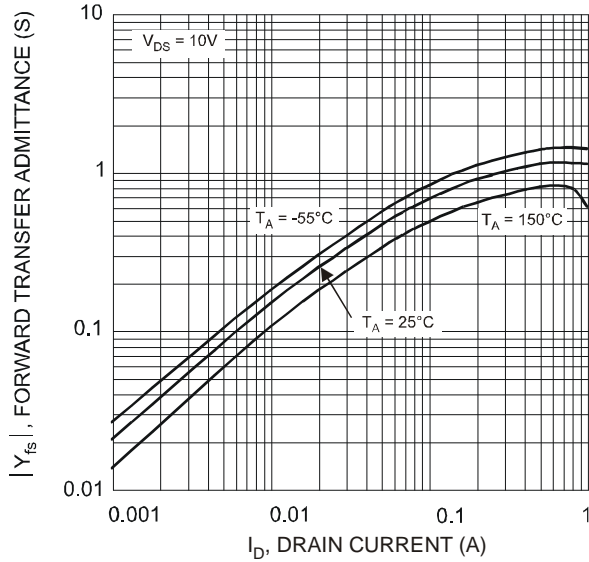

Fig. 9 Forward Transfer Admittance vs. Drain Current

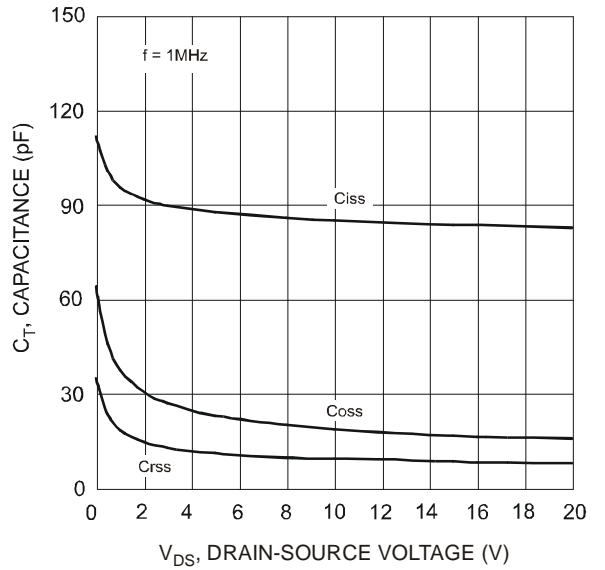

Fig. 10 Typical Capacitance

Q₂, P-CHANNEL

NEW PRODUCT

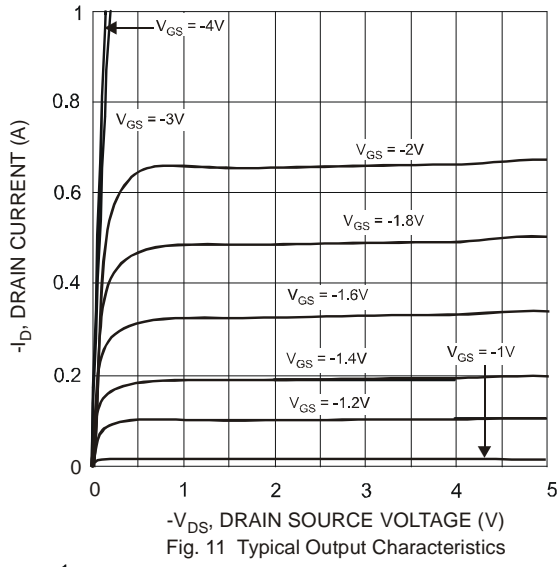

Fig. 11 Typical Output Characteristics

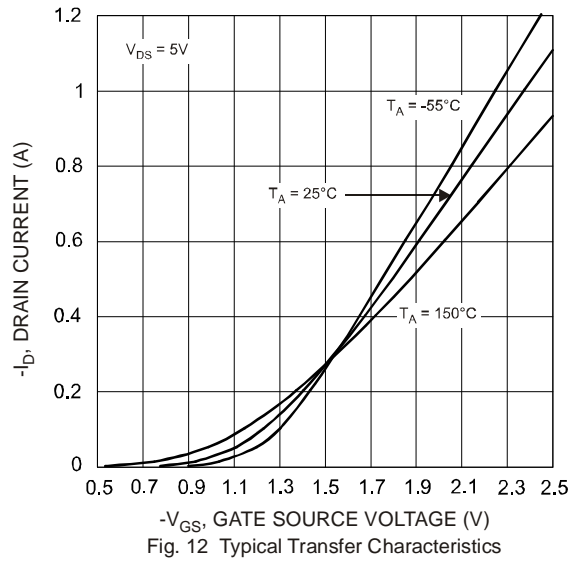

Fig. 12 Typical Transfer Characteristics

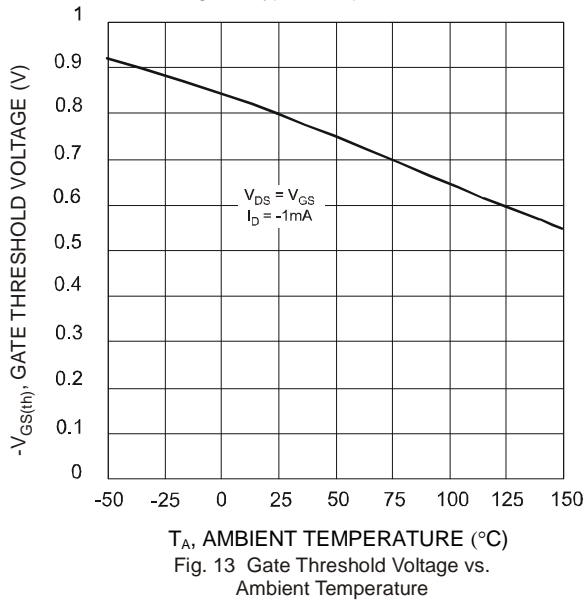

Fig. 13 Gate Threshold Voltage vs. Ambient Temperature

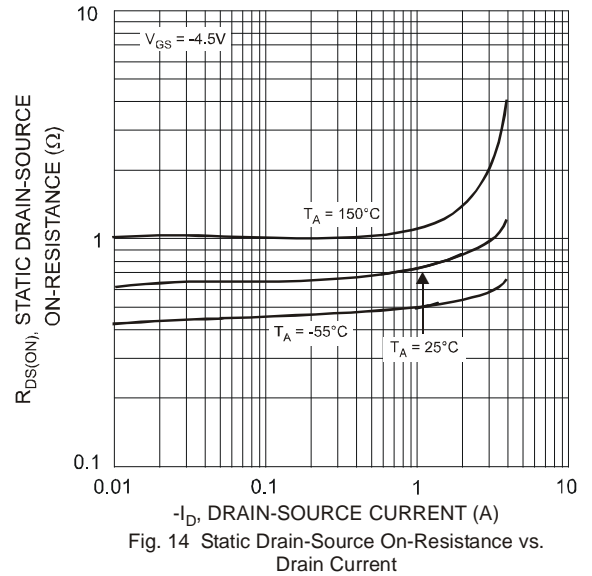

Fig. 14 Static Drain-Source On-Resistance vs. Drain Current

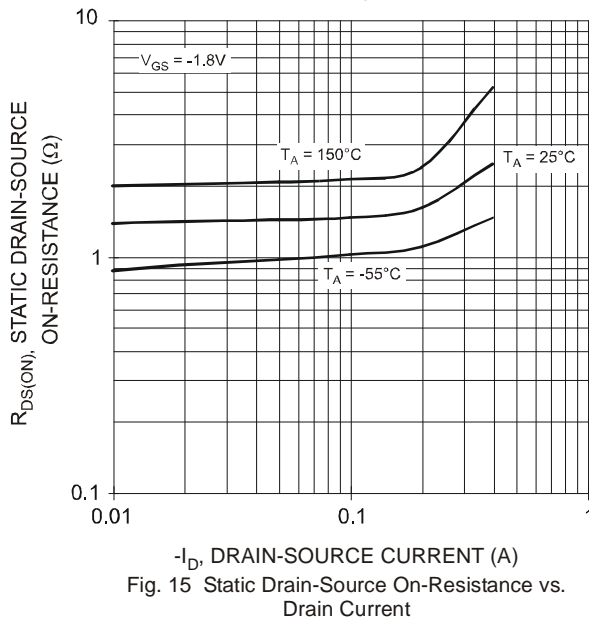

Fig. 15 Static Drain-Source On-Resistance vs. Drain Current

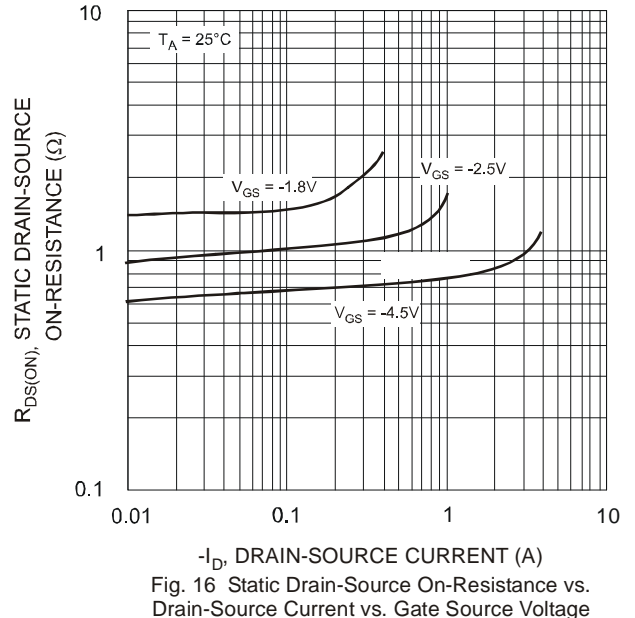

Fig. 16 Static Drain-Source On-Resistance vs. Drain-Source Current vs. Gate Source Voltage

Q₂ P-CHANNEL (continued)

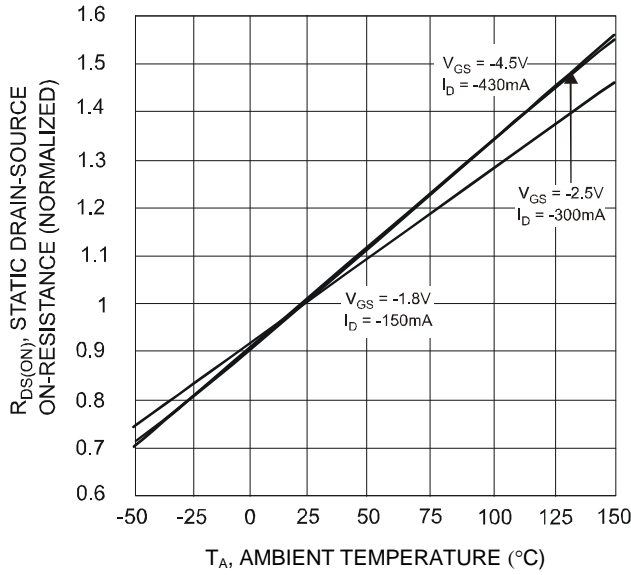

Fig. 17 Static Drain-Source On-State Resistance vs. Ambient Temperature

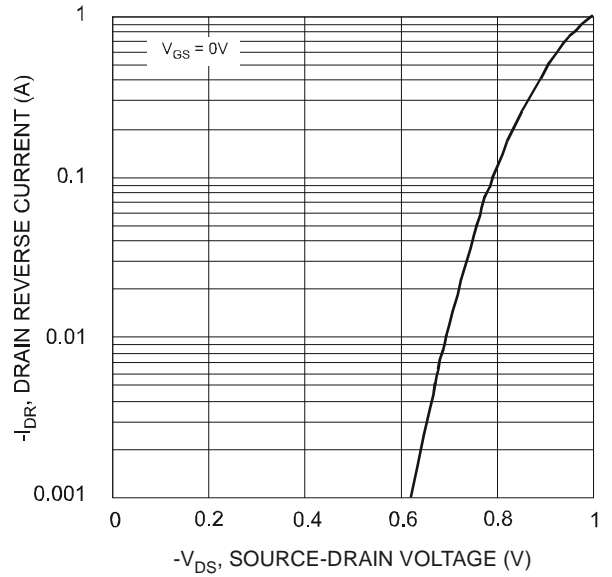

Fig. 18 Reverse Drain Current vs. Source-Drain Voltage

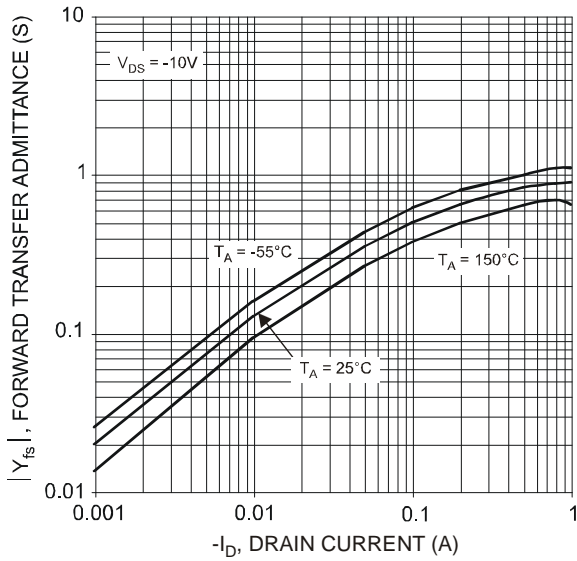

Fig. 19 Forward Transfer Admittance vs. Drain Current

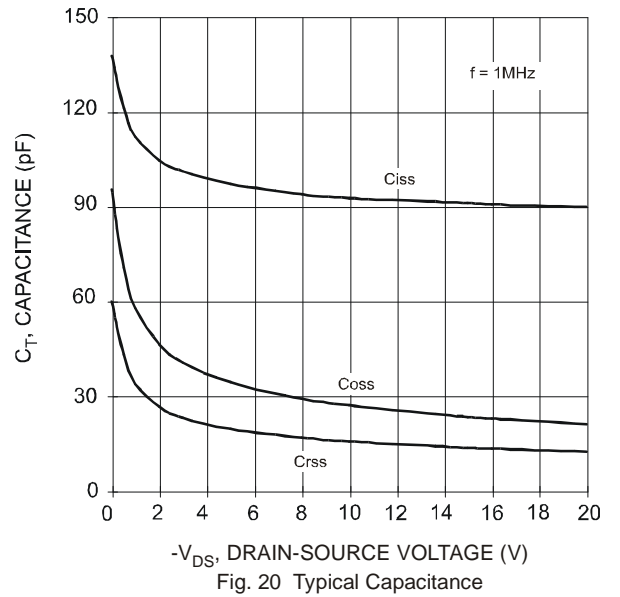

Fig. 20 Typical Capacitance

Ordering Information (Note 6)

Part Number	Case	Packaging
DMC2004DWK-7	SOT-363	3000/Tape & Reel

Notes: 6. For packaging details, go to our website at <https://www.diodes.com/design/support/packaging/diodes-packaging/>.

Marking Information

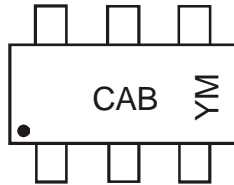

CAB = Marking Code
 YM = Date Code Marking
 Y = Year ex: U = 2007
 M = Month ex: 9 = September

Date Code Key

Year	2007	2008	2009	2010	2011	2012
Code	U	V	W	X	Y	Z

Month	Jan	Feb	Mar	Apr	May	Jun	Jul	Aug	Sep	Oct	Nov	Dec
Code	1	2	3	4	5	6	7	8	9	O	N	D

Package Outline Dimensions

Please see <http://www.diodes.com/package-outlines.html> for the latest version.

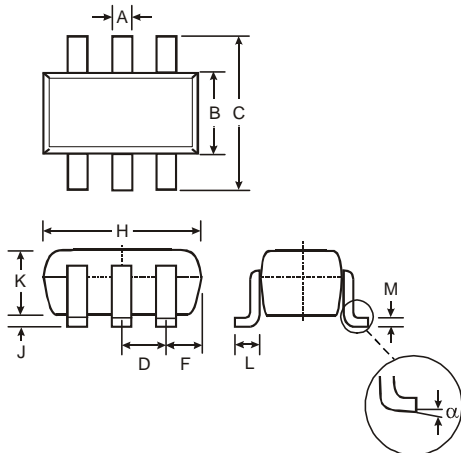

SOT-363		
Dim	Min	Max
A	0.10	0.30
B	1.15	1.35
C	2.00	2.20
D	0.65 Nominal	
F	0.30	0.40
H	1.80	2.20
J	—	0.10
K	0.90	1.00
L	0.25	0.40
M	0.10	0.25
α	0°	8°
All Dimensions in mm		

Suggested Pad Layout

Please see <http://www.diodes.com/package-outlines.html> for the latest version.

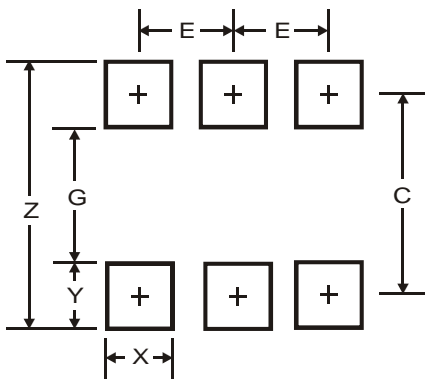

Dimensions	Value (in mm)
Z	2.5
G	1.3
X	0.42
Y	0.6
C	1.9
E	0.65

IMPORTANT NOTICE

DIODES INCORPORATED MAKES NO WARRANTY OF ANY KIND, EXPRESS OR IMPLIED, WITH REGARDS TO THIS DOCUMENT, INCLUDING, BUT NOT LIMITED TO, THE IMPLIED WARRANTIES OF MERCHANTABILITY AND FITNESS FOR A PARTICULAR PURPOSE (AND THEIR EQUIVALENTS UNDER THE LAWS OF ANY JURISDICTION).

Diodes Incorporated and its subsidiaries reserve the right to make modifications, enhancements, improvements, corrections or other changes without further notice to this document and any product described herein. Diodes Incorporated does not assume any liability arising out of the application or use of this document or any product described herein; neither does Diodes Incorporated convey any license under its patent or trademark rights, nor the rights of others. Any Customer or user of this document or products described herein in such applications shall assume all risks of such use and will agree to hold Diodes Incorporated and all the companies whose products are represented on Diodes Incorporated website, harmless against all damages.

Diodes Incorporated does not warrant or accept any liability whatsoever in respect of any products purchased through unauthorized sales channel. Should Customers purchase or use Diodes Incorporated products for any unintended or unauthorized application, Customers shall indemnify and hold Diodes Incorporated and its representatives harmless against all claims, damages, expenses, and attorney fees arising out of, directly or indirectly, any claim of personal injury or death associated with such unintended or unauthorized application.

Products described herein may be covered by one or more United States, international or foreign patents pending. Product names and markings noted herein may also be covered by one or more United States, international or foreign trademarks.

This document is written in English but may be translated into multiple languages for reference. Only the English version of this document is the final and determinative format released by Diodes Incorporated.

LIFE SUPPORT

Diodes Incorporated products are specifically not authorized for use as critical components in life support devices or systems without the express written approval of the Chief Executive Officer of Diodes Incorporated. As used herein:

A. Life support devices or systems are devices or systems which:

1. are intended to implant into the body, or
2. support or sustain life and whose failure to perform when properly used in accordance with instructions for use provided in the labeling can be reasonably expected to result in significant injury to the user.

B. A critical component is any component in a life support device or system whose failure to perform can be reasonably expected to cause the failure of the life support device or to affect its safety or effectiveness.

Customers represent that they have all necessary expertise in the safety and regulatory ramifications of their life support devices or systems, and acknowledge and agree that they are solely responsible for all legal, regulatory and safety-related requirements concerning their products and any use of Diodes Incorporated products in such safety-critical, life support devices or systems, notwithstanding any devices- or systems-related information or support that may be provided by Diodes Incorporated. Further, Customers must fully indemnify Diodes Incorporated and its representatives against any damages arising out of the use of Diodes Incorporated products in such safety-critical, life support devices or systems.

Copyright © 2019, Diodes Incorporated

www.diodes.com