



N-Channel Depletion-Mode Vertical DMOS FET

Features

- ▶ High input impedance
- ▶ Low input capacitance
- ▶ Fast switching speeds
- ▶ Low on resistance
- ▶ Free from secondary breakdown
- ▶ Low input and output leakage

Applications

- ▶ Normally-on switches
- ▶ Solid state relays
- ▶ Converters
- ▶ Linear amplifiers
- ▶ Constant current sources
- ▶ Power supply circuits
- ▶ Telecom

General Description

These depletion-mode (normally-on) transistors utilize an advanced vertical DMOS structure and Supertex's well-proven silicon-gate manufacturing process. This combination produces devices with the power handling capabilities of bipolar transistors and with the high input impedance and positive temperature coefficient inherent in MOS devices. Characteristic of all MOS structures, these devices are free from thermal runaway and thermally-induced secondary breakdown.

Supertex's vertical DMOS FETs are ideally suited to a wide range of switching and amplifying applications where high breakdown voltage, high input impedance, low input capacitance, and fast switching speeds are desired.

Absolute Maximum Ratings

| Parameter | Value |
|-----------------------------------|-----------------------------------|
| Drain-to-source voltage | BV_{DSX} |
| Drain-to-gate voltage | BV_{DGX} |
| Gate-to-source voltage | $\pm 20V$ |
| Operating and storage temperature | $-55^{\circ}C$ to $+150^{\circ}C$ |
| Soldering temperature* | $300^{\circ}C$ |

Absolute Maximum Ratings are those values beyond which damage to the device may occur. Functional operation under these conditions is not implied. Continuous operation of the device at the absolute rating level may affect device reliability. All voltages are referenced to device ground.

*Distance of 1.6mm from case for 10 seconds.

Package Options

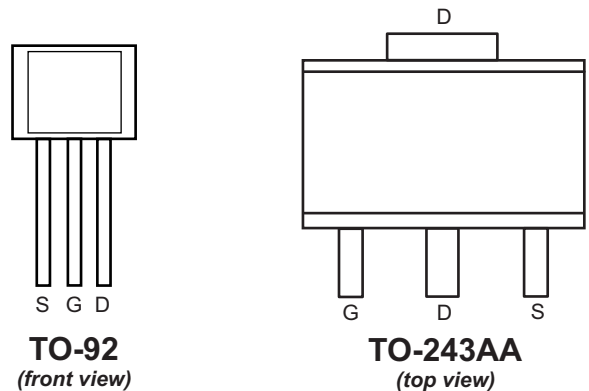

Ordering Information

| BV_{DSX}/BV_{DGX} | $R_{DS(ON)}$ (max) | I_{DSS} (min) | Package Options | |
|---------------------|--------------------|-----------------|-----------------|-------------------|
| | | | TO-92 | TO-243AA (SOT-89) |
| 450V | 20Ω | 200mA | DN3545N3 | DN3545N8 |
| | | | DN3545N3-G | DN3545N8-G |

-G indicates package is RoHS compliant ('Green')



Thermal Characteristics

| Package | I_D (continuous) ¹ | I_D (pulsed) | Power Dissipation @ $T_A = 25^\circ\text{C}$ | θ_{jc} $^\circ\text{C/W}$ | θ_{ja} $^\circ\text{C/W}$ | I_{DR}^1 | I_{DRM} |
|----------|------------------------------------|-------------------|---|-------------------------------------|-------------------------------------|------------|-----------|
| T0-92 | 136mA | 550mA | 0.74W | 125 | 170 | 136mA | 550mA |
| TO-243AA | 200mA | 550mA | 1.6W ² | 15 | 78 ² | 200mA | 550mA |

Notes:

- I_D (continuous) is limited by max rated T_r .
- Mounted on FR4 board, 25mm x 25mm x 1.57mm. Significant P_D increase possible on ceramic substrate.

Electrical Characteristics (@25°C unless otherwise specified)

| Symbol | Parameter | Min | Typ | Max | Units | Conditions |
|----------------------|--|------|-----|------|----------------------|---|
| BV_{DSX} | Drain-to-source breakdown voltage | 450 | - | - | V | $V_{GS} = -5V, I_D = 100\mu\text{A}$ |
| $V_{GS(OFF)}$ | Gate-to-source OFF voltage | -1.5 | - | -3.5 | V | $V_{DS} = 25V, I_D = 10\mu\text{A}$ |
| $\Delta V_{GS(OFF)}$ | Change in $V_{GS(OFF)}$ with temperature | - | - | 4.5 | mV/ $^\circ\text{C}$ | $V_{DS} = 25V, I_D = 10\mu\text{A}$ |
| I_{GSS} | Gate body leakage current | - | - | 100 | nA | $V_{GS} = \pm 20V, V_{DS} = 0V$ |
| $I_{D(OFF)}$ | Drain-to-source leakage current | - | - | 1.0 | μA | $V_{GS} = -5V, V_{DS} = \text{Max Rating}$ |
| | | - | - | 1.0 | mA | $V_{GS} = -5V, V_{DS} = 0.8 \text{ Max Rating}$ $T_A = 125^\circ\text{C}$ |
| I_{DSS} | Saturated drain-to-source current | 200 | - | - | mA | $V_{GS} = 0V, V_{DS} = 15V$ |
| $R_{DS(ON)}$ | Static drain-to-source on-state resistance | - | - | 20 | Ω | $V_{GS} = 0V, I_D = 150\text{mA}$ |
| $\Delta R_{DS(ON)}$ | Change in $R_{DS(ON)}$ with temperature | - | - | 1.1 | %/ $^\circ\text{C}$ | $V_{GS} = 0V, I_D = 150\text{mA}$ |
| G_{FS} | Forward transductance | 150 | - | - | m Ω | $I_D = 100\text{mA}, V_{DS} = 10V$ |
| C_{ISS} | Input capacitance | - | - | 360 | pF | $V_{GS} = -5V, V_{DS} = 25V, f = 1\text{MHz}$ |
| C_{OSS} | Common source output capacitance | - | - | 40 | | |
| C_{RSS} | Reverse transfer capacitance | - | - | 15 | | |
| $t_{d(ON)}$ | Turn-ON delay time | - | - | 20 | ns | $V_{DD} = 25V, I_D = 150\text{mA},$ $R_{GEN} = 25\Omega, V_{GS} = 0V \text{ to } -10V$ |
| t_r | Rise time | - | - | 30 | | |
| $t_{d(OFF)}$ | Turn-OFF delay time | - | - | 30 | | |
| t_f | Fall time | - | - | 40 | | |
| V_{SD} | Diode forward voltage drop | - | - | 1.8 | V | $V_{GS} = -5V, I_{SD} = 150\text{mA}$ |
| t_{rr} | Reverse recovery time | - | 800 | - | ns | $V_{GS} = -5V, I_{SD} = 150\text{mA}$ |

Switching Waveforms and Test Circuit

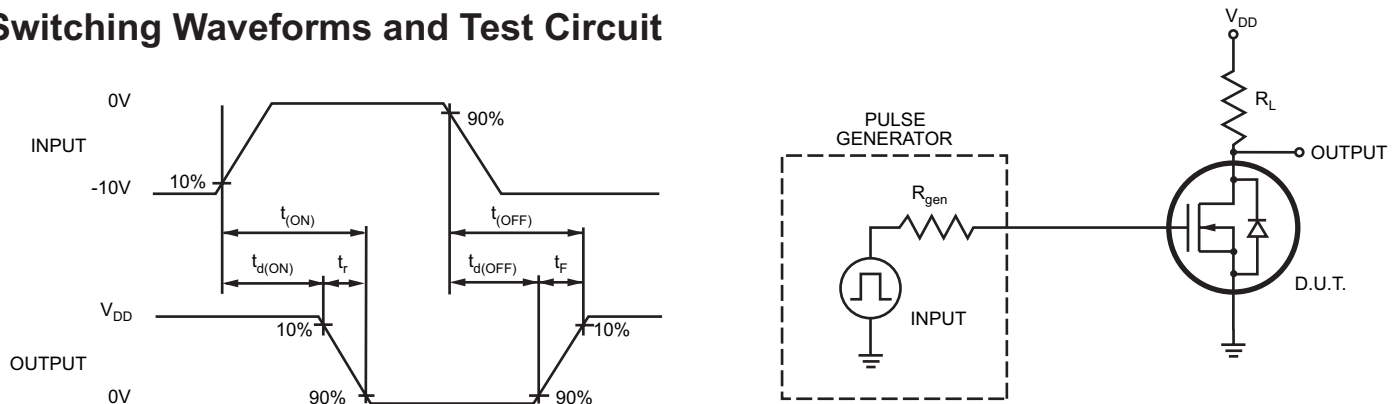

Typical Performance Curves

Output Characteristics

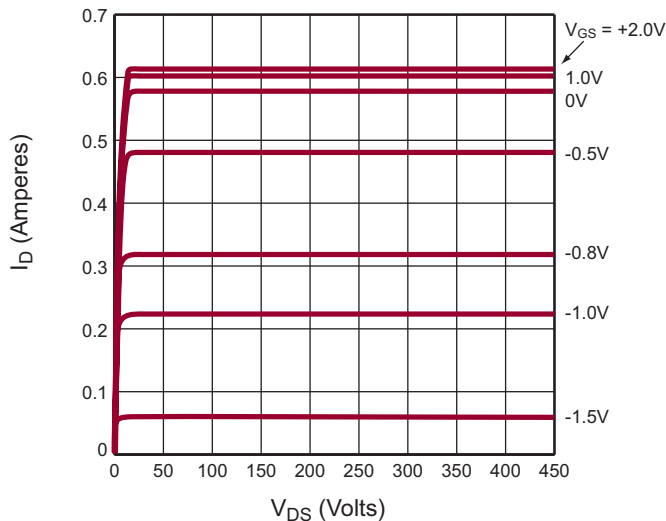

Saturation Characteristics

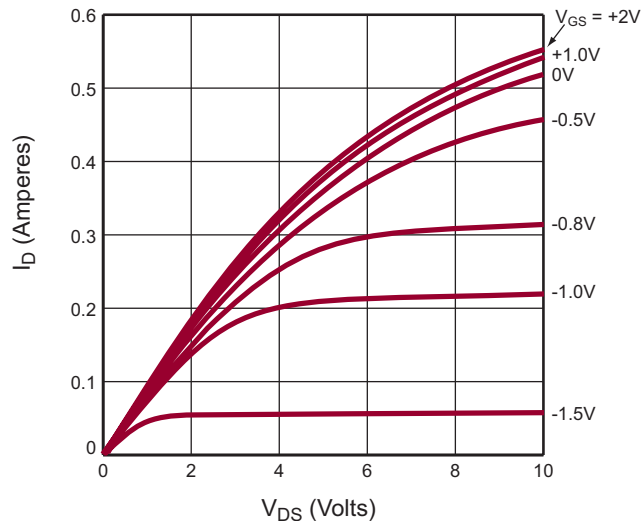

Transconductance vs. Drain Current

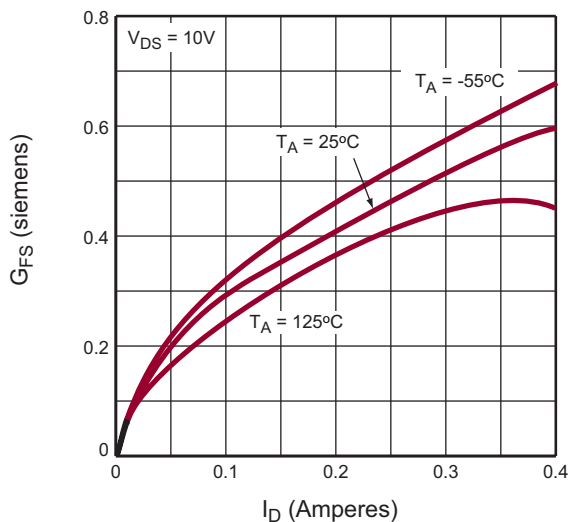

Power Dissipation vs. Ambient Temperature

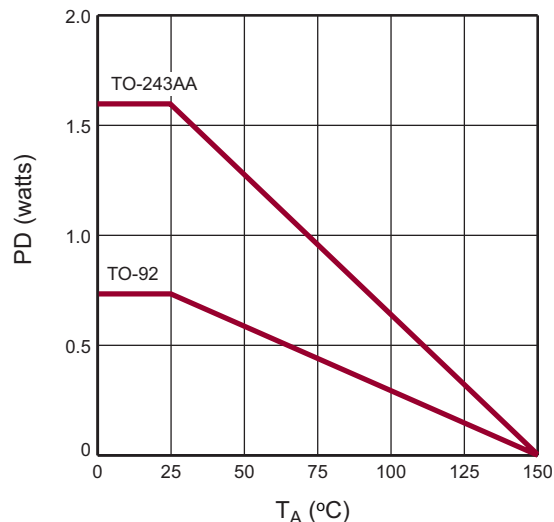

Maximum Rated Safe Operating Area

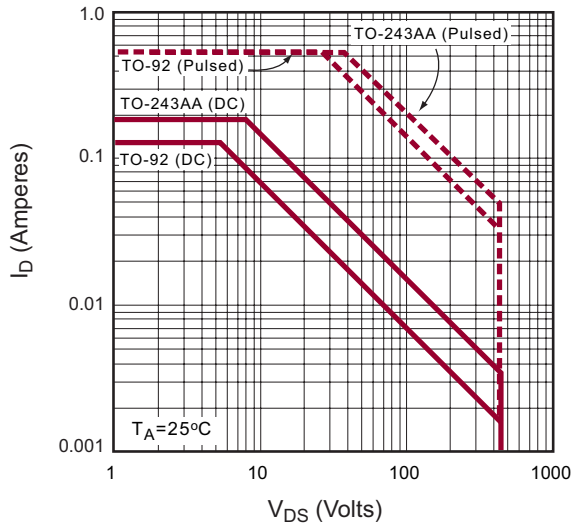

Thermal Response Characteristics

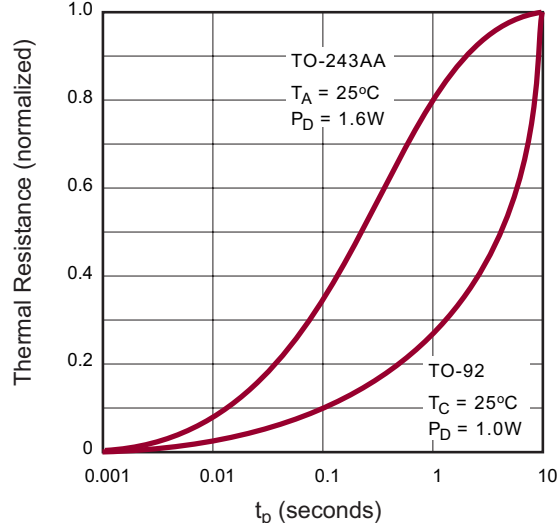

Typical Performance Curves (cont.)

BV_{DSS} Variation with Temperature

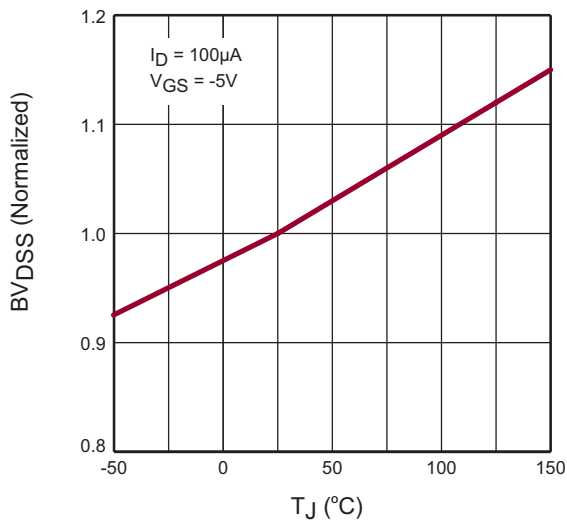

On Resistance vs. Drain Current

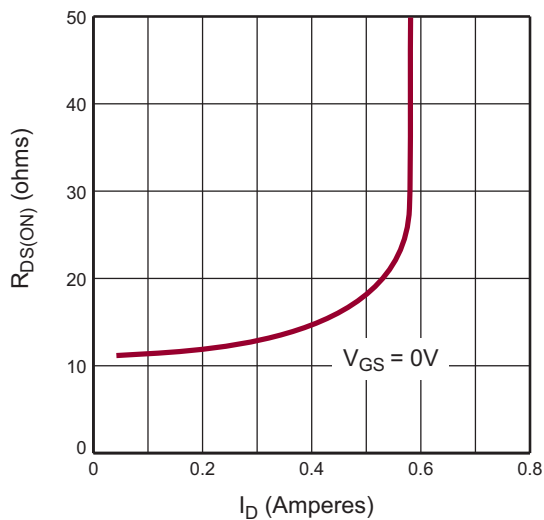

Transfer Characteristics

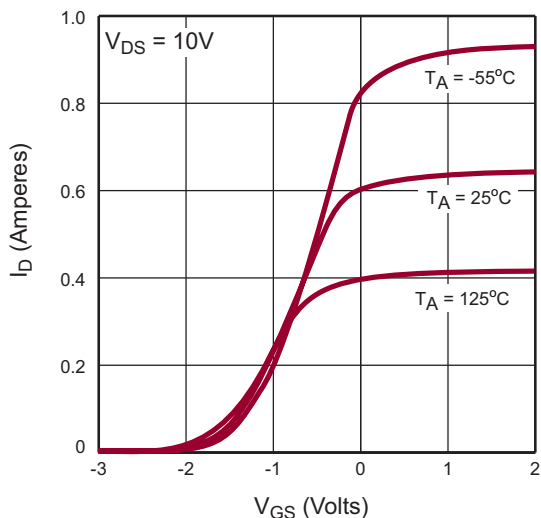

V_{GS(OFF)} and R_{DS(ON)} w/ Temperature

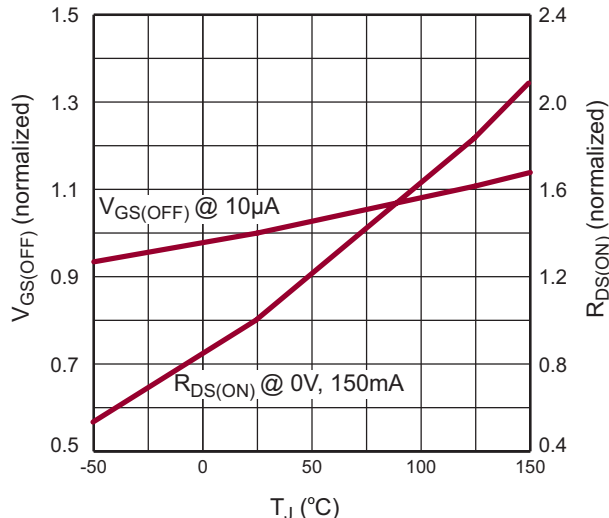

Capacitance vs. Drain Source Voltage

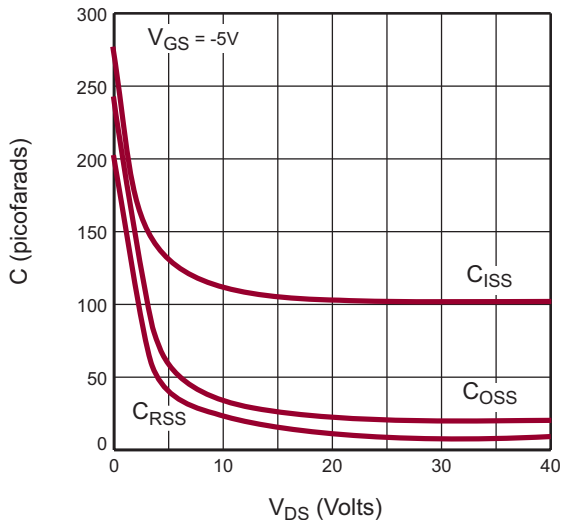

Gate Drive Dynamic Characteristics

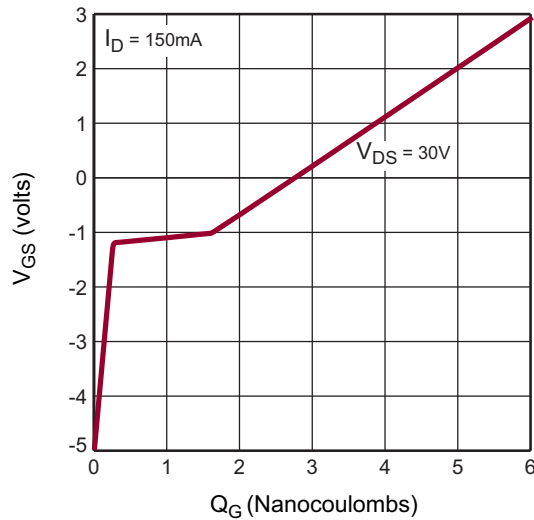

3-Lead TO-92 Surface Mount Package (N3)

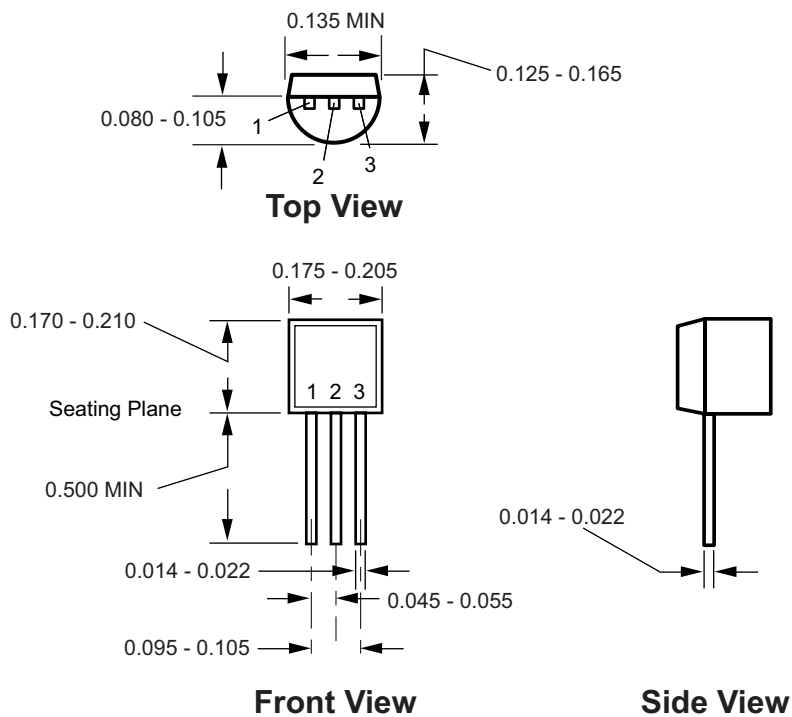

Notes:
 All dimensions are in millimeters; all angles in degrees.

3-Lead TO-243AA (SOT-89) Surface Mount Package (N8)

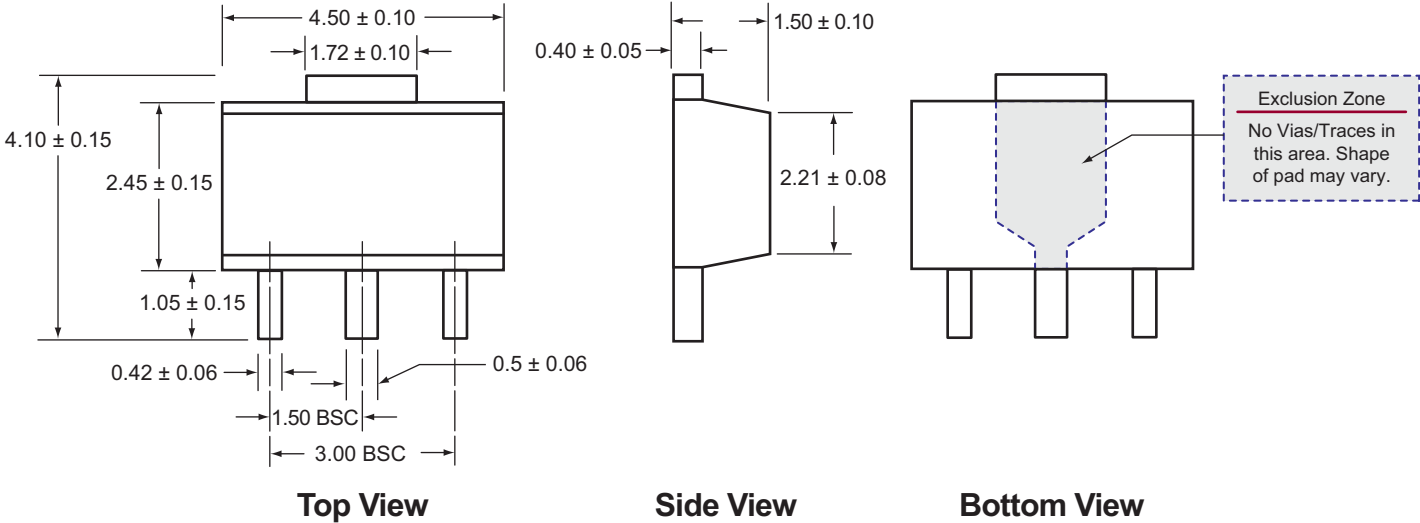

Notes:
 All dimensions are in millimeters; all angles in degrees.

(The package drawing(s) in this data sheet may not reflect the most current specifications. For the latest package outline information go to <http://www.supertex.com/packaging.html>.)

Supertex inc. does not recommend the use of its products in life support applications, and will not knowingly sell its products for use in such applications, unless it receives an adequate "product liability indemnification insurance agreement". **Supertex** does not assume responsibility for use of devices described and limits its liability to the replacement of the devices determined defective due to workmanship. No responsibility is assumed for possible omissions or inaccuracies. Circuitry and specifications are subject to change without notice. For the latest product specifications, refer to the **Supertex** website: <http://www.supertex.com>.

©2007 **Supertex inc.** All rights reserved. Unauthorized use or reproduction is prohibited.