

Rectifier Diode

DS1104



Technical Data

Typical applications :All purpose high power rectifier diodes, Non-controllable and half controlled rectifiers . Free-wheeling diodes & welding.

Type No.	V_{RRM} (Volts)	V_{RSM} (Volts)
DS1104/20	2000	2100
DS1104/24	2400	2500
DS1104/29	2900	3000

Features

- Reverse voltage upto 2900V
- Double side cooling.
- High surge capability.

Symbol	Conditions	Values
$I_{F(AV)}$	Sin 180 ; Tcase = 100 °C	1315 A
I_{FSM}	Tvj = 175 °C ; 10 ms, $V_{RRM} = 50\%$	16 KA
	Tvj = 175 °C ; 10 ms, $V_{RRM} = 0$	20 KA
I^2t	Tvj = 175 °C, $V_{RRM} = 50\%$	1280000 A ² s
	Tvj = 175 °C, $V_{RRM} = 0$	2000000 A ² s
I_{RRM}	Tvj = 175 °C	50 mA max
V_F	Tvj = 25 °C ; $I_F = 1800 A$	1.30 V max
V_0	Tvj = 175 °C	0.67 V
R_0	Tvj = 175 °C	0.31 m
$R_{th(j-c)}$		0.032 °C/W
$R_{th(c-h)}$		0.008 °C/W
T_{vj}		175 °C
T_{stg}		-40.....+ 175 °C
Clamping Force	SI units	12.5-15 KN
Weight	Approx	310 g
Case outline		G



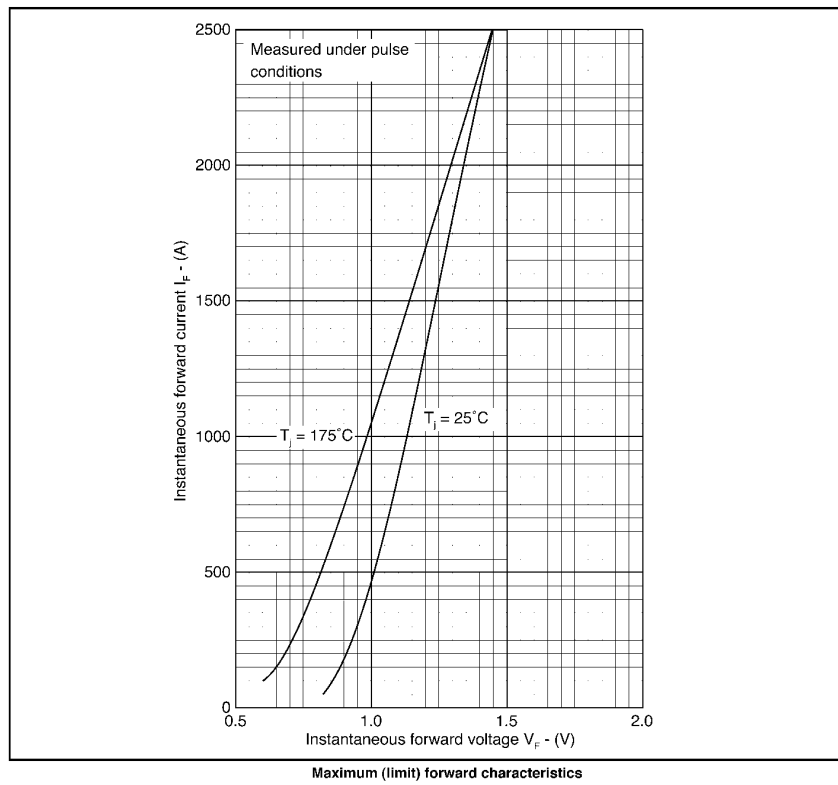
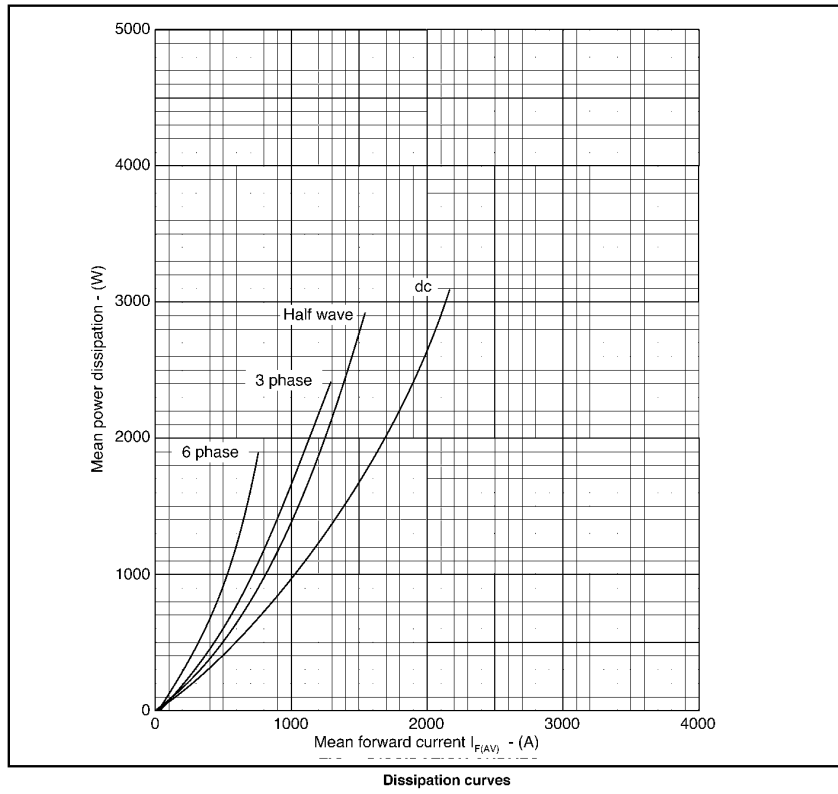

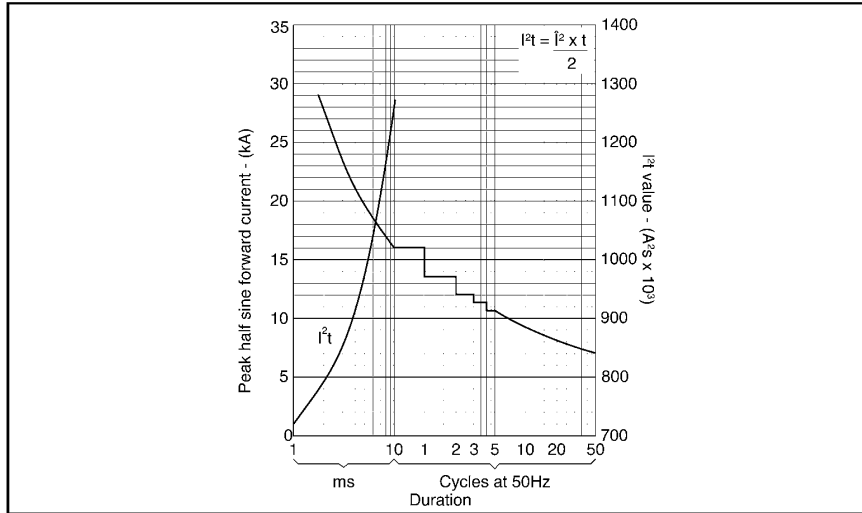

Surge (non-repetitive) forward current vs time (with 50% V_{RRM} , $T_{case} = 175^\circ\text{C}$)

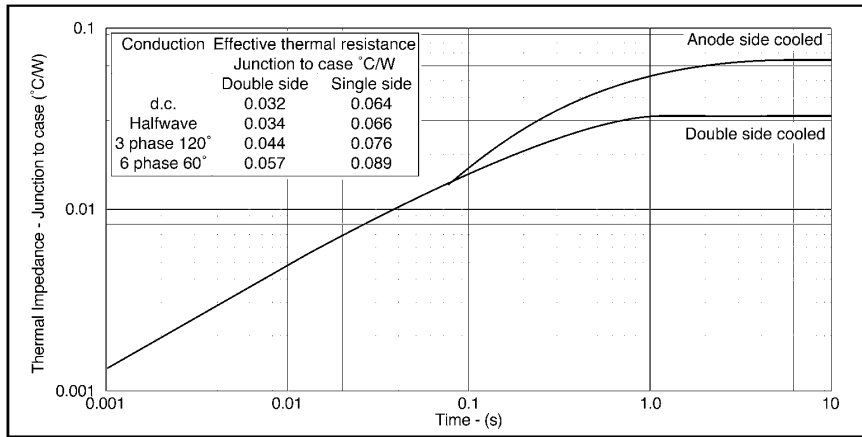

Transient thermal impedance - junction to case - (°C/W)

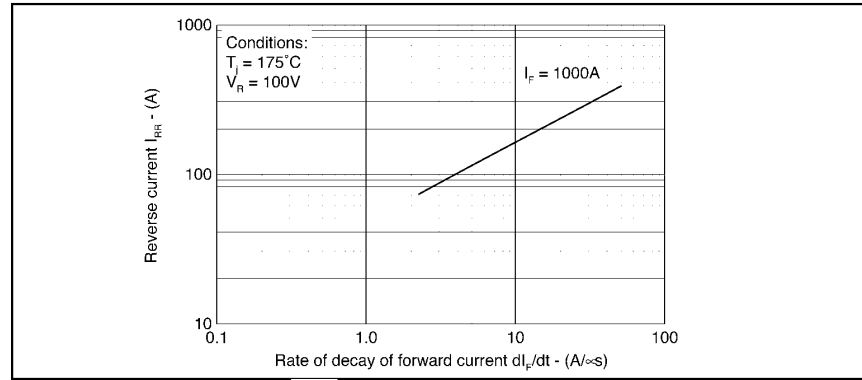

Maximum reverse recovery current

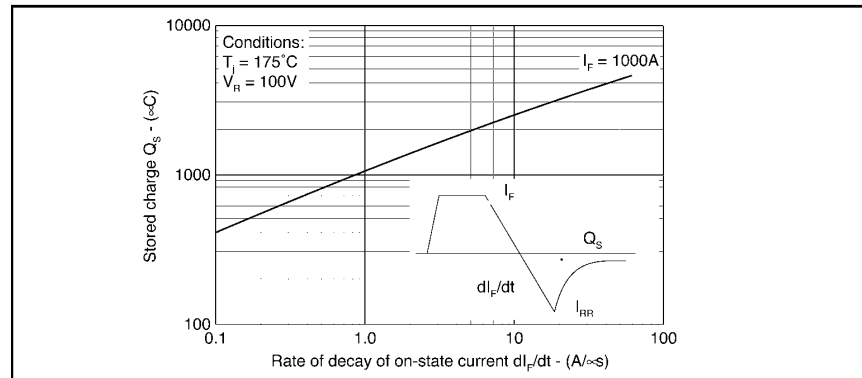

Maximum total stored charge

PACAKAGE DEATILS

DO NOT SCALE

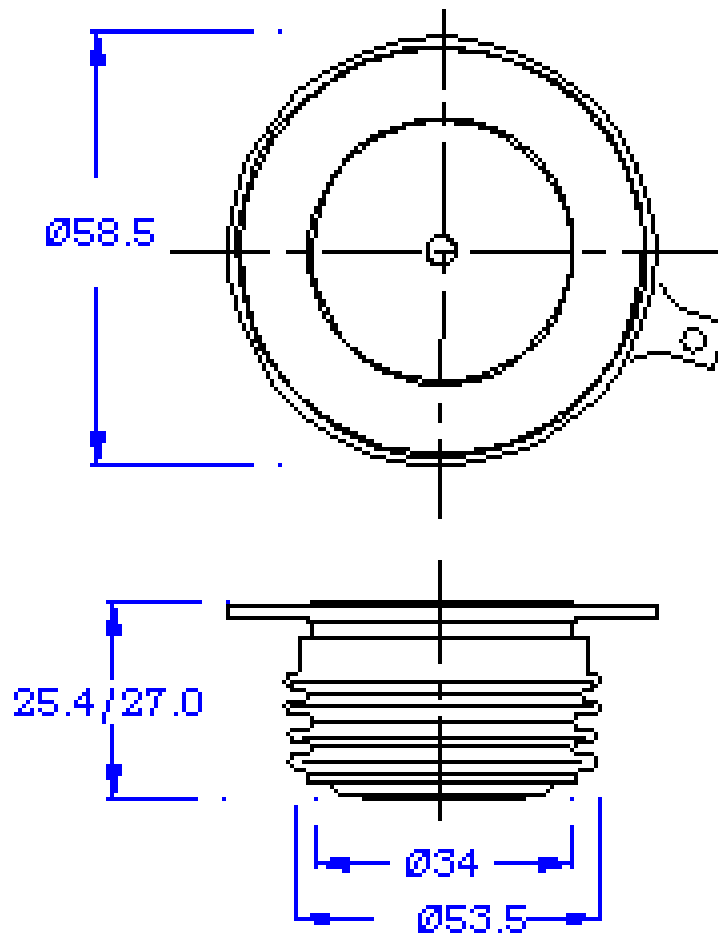

Nominal Weight : 310g
Clamping Force : 12.5-15KN

All Dimensions in mm

Package Outline : G