

Rectifier Diode

DS2004



Technical Data

Typical applications :All purpose high power rectifier diodes, Non-controllable and half controlled rectifiers . Free-wheeling diodes & traction.

Type No.	V_{RRM} (Volts)	V_{RSM} (Volts)
DS2004/18	1800	1900
DS2004/20	2000	2100
DS2004/24	2400	2500
DS2004/28	2800	2900

Features

- Reverse voltage upto 2800V.
- Double side cooling.
- High surge capability.

Symbol	Conditions	Values
$I_{F(AV)}$	Sin 180 ; Tcase = 100 °C	1960 A
I_{FSM}	Tvj = 175 °C ; 10 ms, $V_{RRM} = 50\%$	25 KA
	Tvj = 175 °C ; 10 ms, $V_{RRM} = 0$	31.25 KA
I^2t	Tvj = 175 °C, $V_{RRM} = 50\%$	3120000 A ² s
	Tvj = 175 °C, $V_{RRM} = 0$	4880000 A ² s
I_{RRM}	Tvj = 175 °C	50 mA max
V_F	Tvj = 25 °C ; $I_F = 3400 A$	1.30 V max
V_0	Tvj = 175 °C	0.82 V
R_0	Tvj = 175 °C	0.16 m
$R_{th(j-c)}$		0.022 °C/W
$R_{th(c-h)}$		0.004 °C/W
T_{vj}		175 °C
T_{stg}		-40.....+ 180 °C
Mounting Force	SI units	20-22 KN
Weight	Approx	500 g
Case outline		F



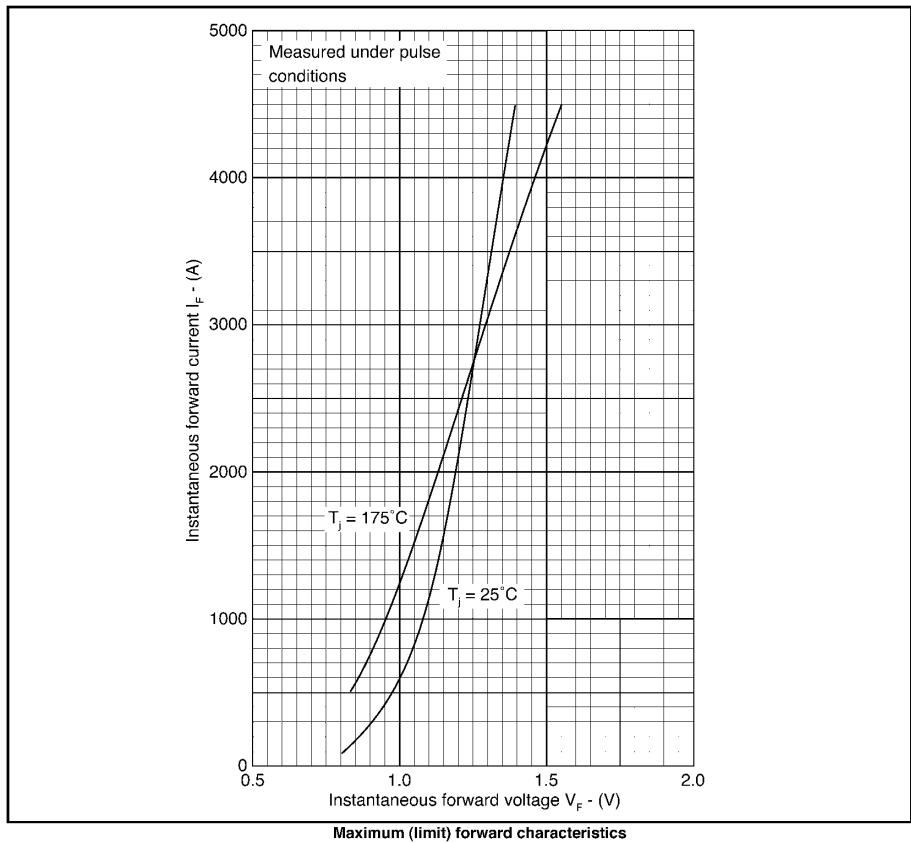
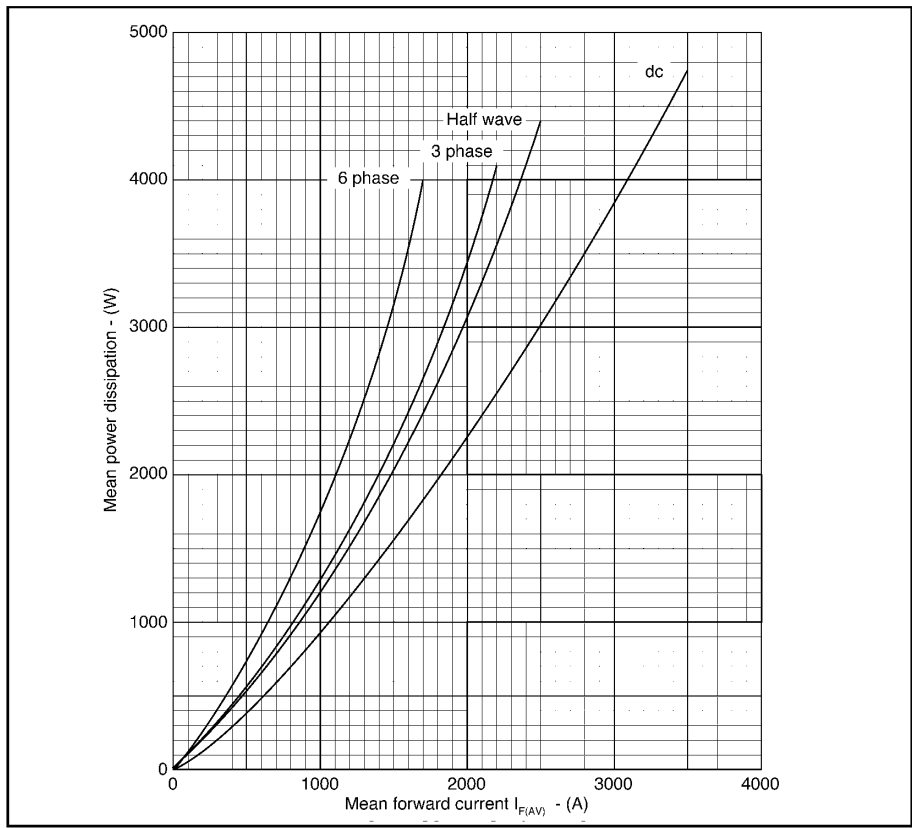

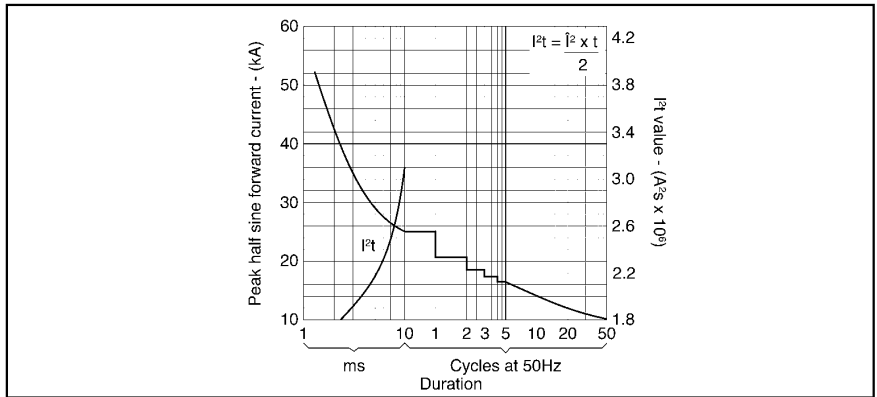

Surge (non-repetitive) forward current vs time ($T_{case} = 175^\circ\text{C}$)

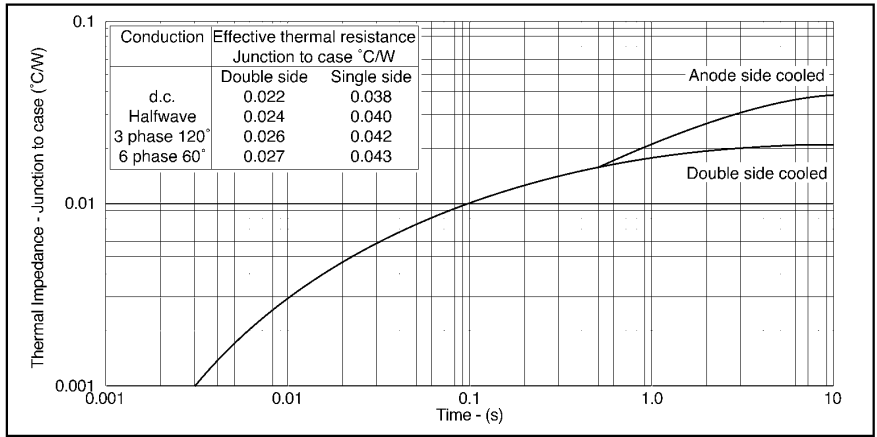

Maximum (limit) transient thermal impedance - junction to case - (°C/W)

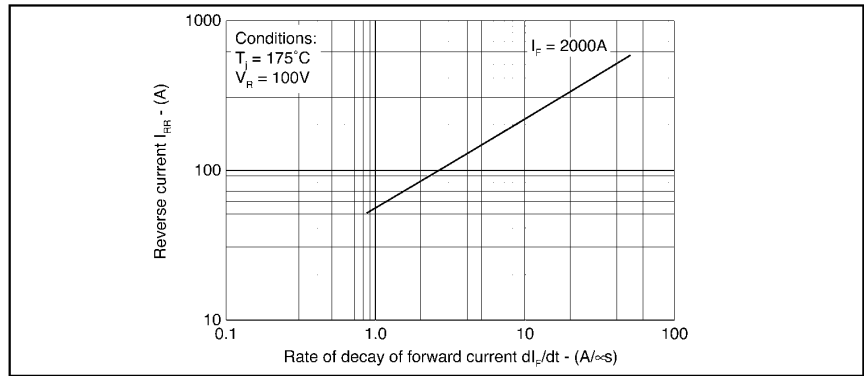

Maximum reverse recovery current

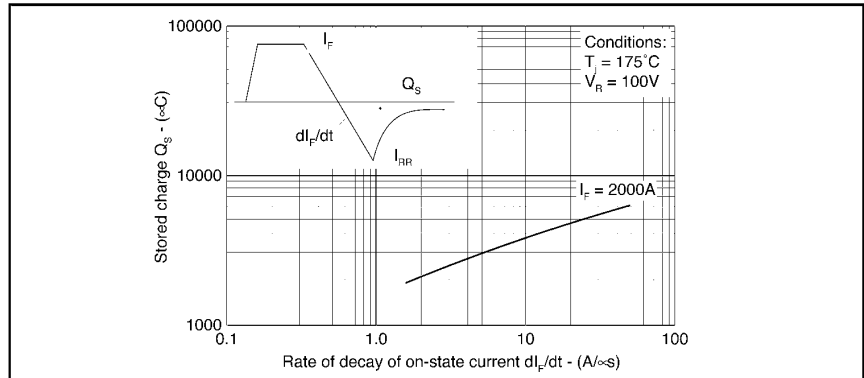

Maximum total stored charge

PACAKAGE DEATILS

DO NOT SCALE

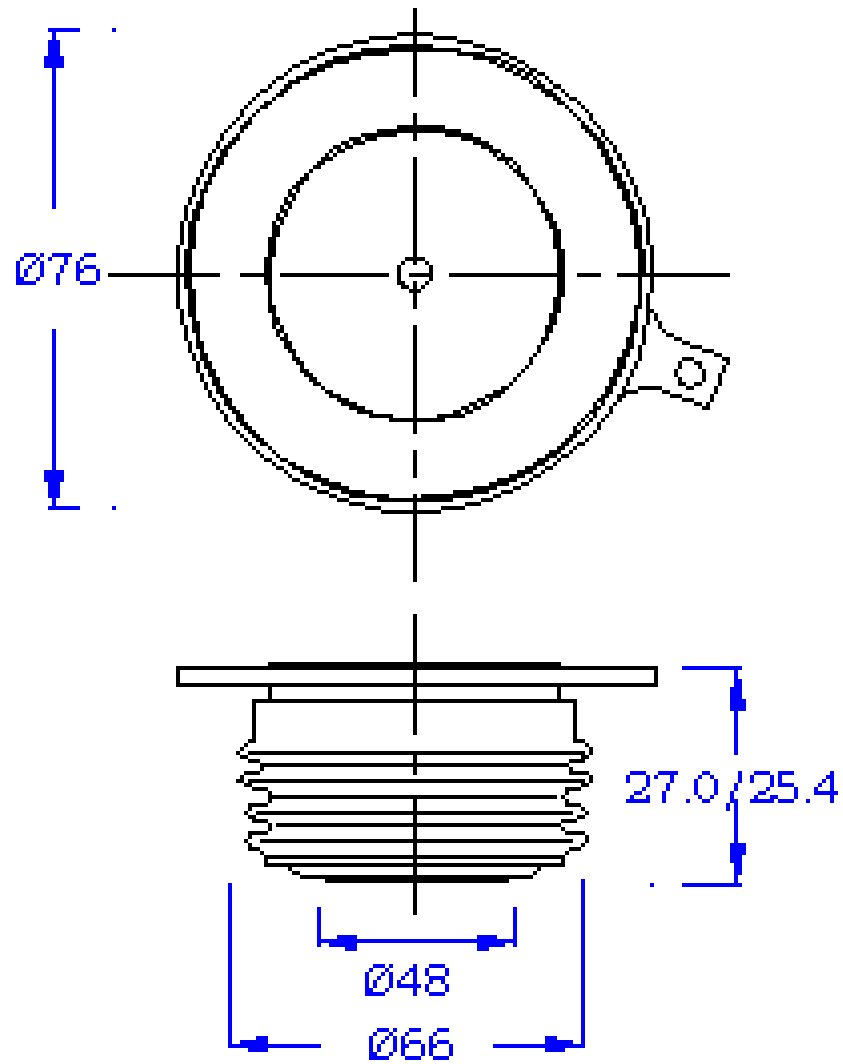

Nominal Weight : 500g
Clamping Force : 20-22KN

All Dimensions in mm

Package Outline : F