



FEATURES

- Double Side Cooling
- High Surge Capability

APPLICATIONS

- Rectification
- Free-wheel Diode
- DC Motor Control
- Power Supplies
- Welding
- Battery Chargers

VOLTAGE RATINGS

Part and Ordering Number	Repetitive Peak Voltages V_{DRM} and V_{DRM} V	Conditions
DS2906SA40	4000	$V_{RSM} = V_{RRM} + 100V$
DS2906SA39	3900	
DS2906SA38	3800	
DS2906SA37	3700	
DS2906SA36	3600	
DS2906SA35	3500	

Lower voltage grades available.

ORDERING INFORMATION

When ordering, select the required part number shown in the Voltage Ratings selection table.

For example:

DS2906SA39

Note: Please use the complete part number when ordering and quote this number in any future correspondence relating to your order.

KEY PARAMETERS

V_{RRM}	4000V
$I_{F(AV)}$	5651A
I_{FSM}	83000A

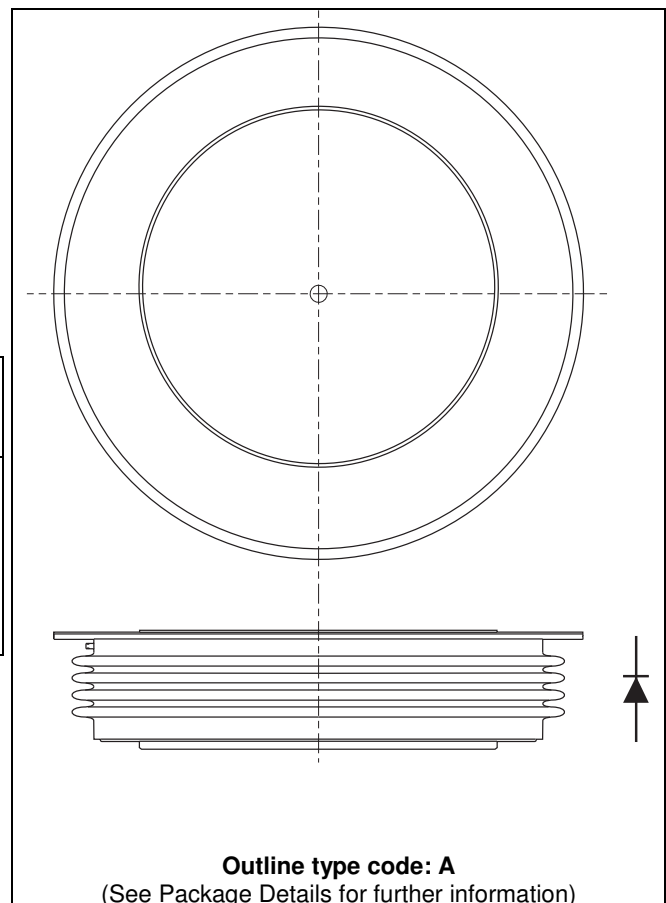

Fig. 1 Package outlines

CURRENT RATINGS

T_{case} = 75°C unless stated otherwise

Symbol	Parameter	Test Conditions	Max.	Units
Double Side Cooled				
I _{F(AV)}	Mean forward current	Half wave resistive load	5651	A
I _{F(RMS)}	RMS value	-	8877	A
I _F	Continuous (direct) on-state current	-	8208	A
Single Side Cooled (Anode side)				
I _{F(AV)}	Mean forward current	Half wave resistive load	3707	A
I _{F(RMS)}	RMS value	-	5821	A
I _F	Continuous (direct) on-state current	-	4976	A

T_{case} = 100°C unless stated otherwise

Symbol	Parameter	Test Conditions	Max.	Units
Double Side Cooled				
I _{F(AV)}	Mean forward current	Half wave resistive load	4350	A
I _{F(RMS)}	RMS value	-	6830	A
I _F	Continuous (direct) on-state current	-	6160	A
Single Side Cooled (Anode side)				
I _{F(AV)}	Mean forward current	Half wave resistive load	2795	A
I _{F(RMS)}	RMS value	-	4390	A
I _F	Continuous (direct) on-state current	-	3640	A

SURGE RATINGS

Symbol	Parameter	Test Conditions	Max.	Units
I_{FSM}	Surge (non-repetitive) on-state current	10ms half sine, $T_{case} = 150^{\circ}C$ $V_R = 50\% V_{RRM} - 1/4$ sine	66.5	kA
I^2t	I^2t for fusing		22	MA ² s
I_{FSM}	Surge (non-repetitive) on-state current	10ms half sine, $T_{case} = 150^{\circ}C$ $V_R = 0$	83	kA
I^2t	I^2t for fusing		34.5	MA ² s

THERMAL AND MECHANICAL RATINGS

Symbol	Parameter	Test Conditions	Min.	Max.	Units	
$R_{th(j-c)}$	Thermal resistance – junction to case	Double side cooled	DC	-	0.0065	$^{\circ}C/W$
		Single side cooled	Anode DC	-	0.013	$^{\circ}C/W$
			Cathode DC	-	0.013	$^{\circ}C/W$
$R_{th(c-h)}$	Thermal resistance – case to heatsink	Clamping force 83.0kN (with mounting compound)	Double side	-	0.001	$^{\circ}C/W$
			Single side	-	0.002	$^{\circ}C/W$
T_{vj}	Virtual junction temperature	On-state (conducting)		-	160	$^{\circ}C$
		Reverse (blocking)		-	150	$^{\circ}C$
T_{stg}	Storage temperature range		-55	150	$^{\circ}C$	
F_m	Clamping force		75.0	91.0	kN	

CHARACTERISTICS

Symbol	Parameter	Test Conditions	Min.	Max.	Units
V_{FM}	Forward voltage	At 3000A peak, $T_{case} = 25^{\circ}C$	-	1.06	V
I_{RM}	Peak reverse current	At V_{DRM} , $T_{case} = 150^{\circ}C$	-	400	mA
V_{TO}	Threshold voltage	At $T_{vj} = 150^{\circ}C$	-	0.78	V
r_T	Slope resistance	At $T_{vj} = 150^{\circ}C$	-	0.0763	m Ω

CURVES

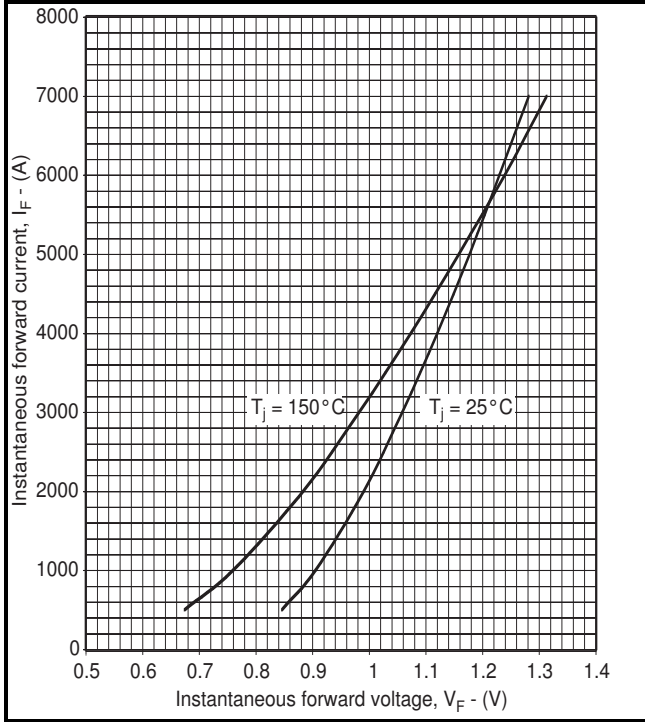

Fig.2 Maximum (limit) forward characteristics

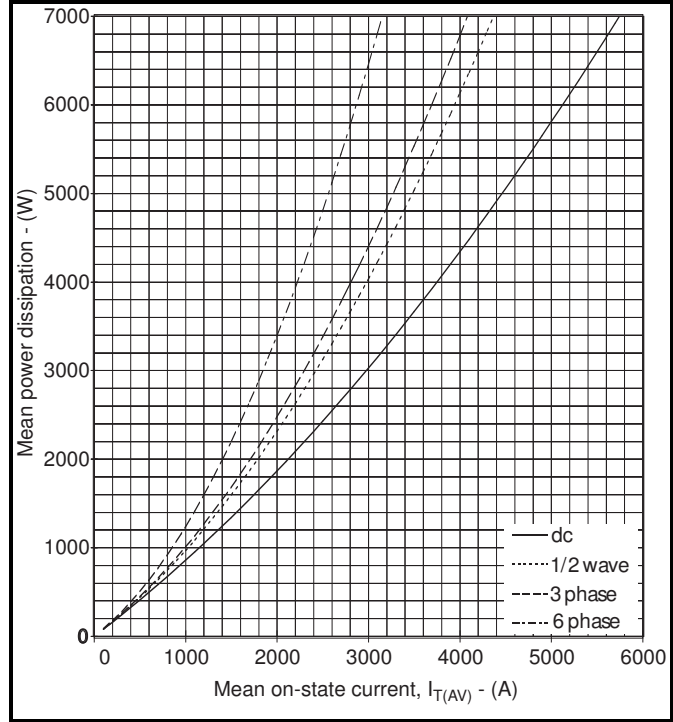

Fig.3 Power loss curves

V_{TM} EQUATION

$$V_{TM} = A + B \ln(I_T) + C \cdot I_T + D \cdot \sqrt{I_T}$$

Where $A = -0.01591$
 $B = 0.113682$
 $C = 8.04 \times 10^{-5}$
 $D = -0.00284$

these values are valid for $T_j = 150^\circ\text{C}$ for I_F 500A to 7000A

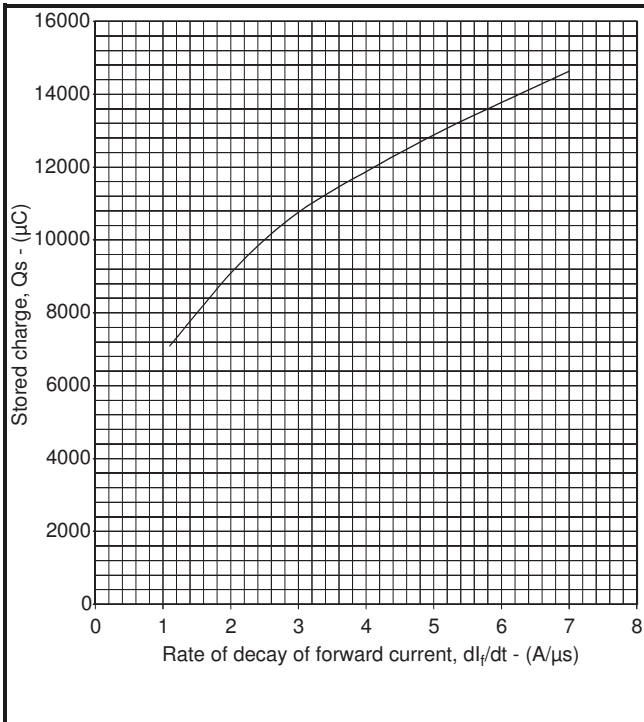

Fig.4 Stored charge

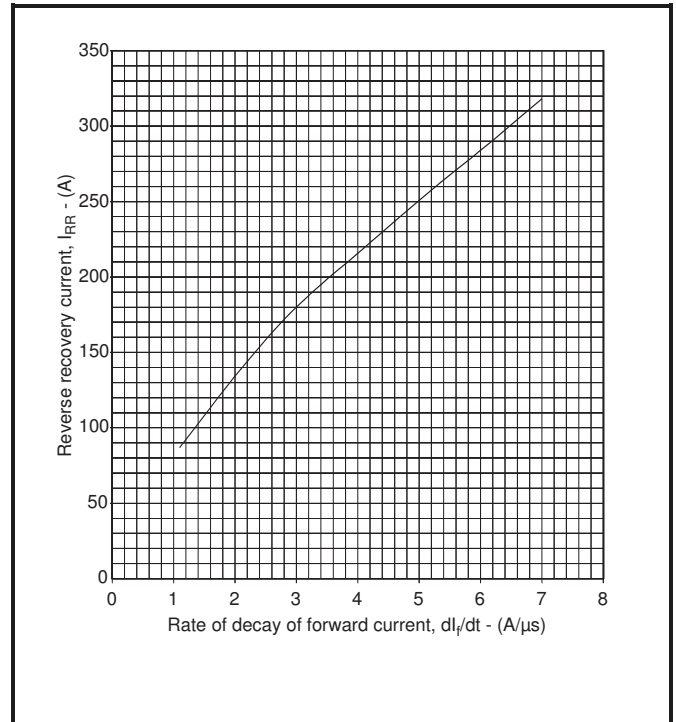

Fig.5 Reverse recovery current

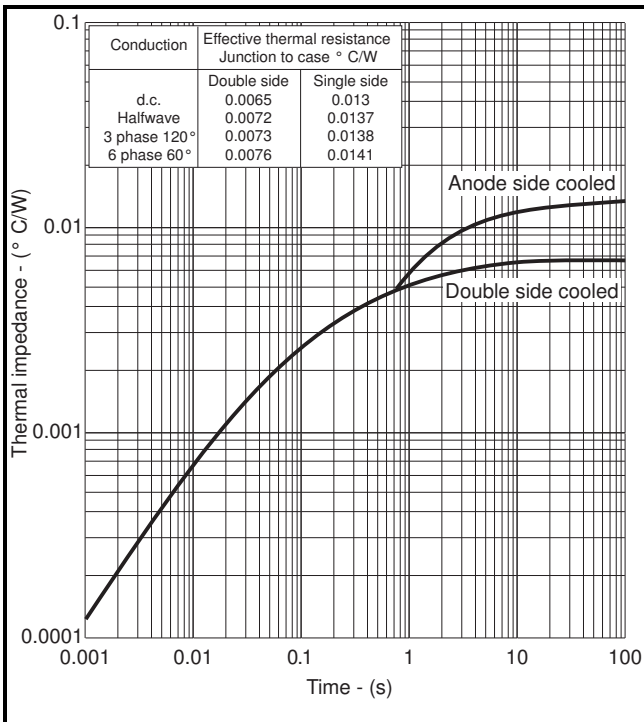

Fig.6 Maximum (limit) transient thermal impedance – junction to case

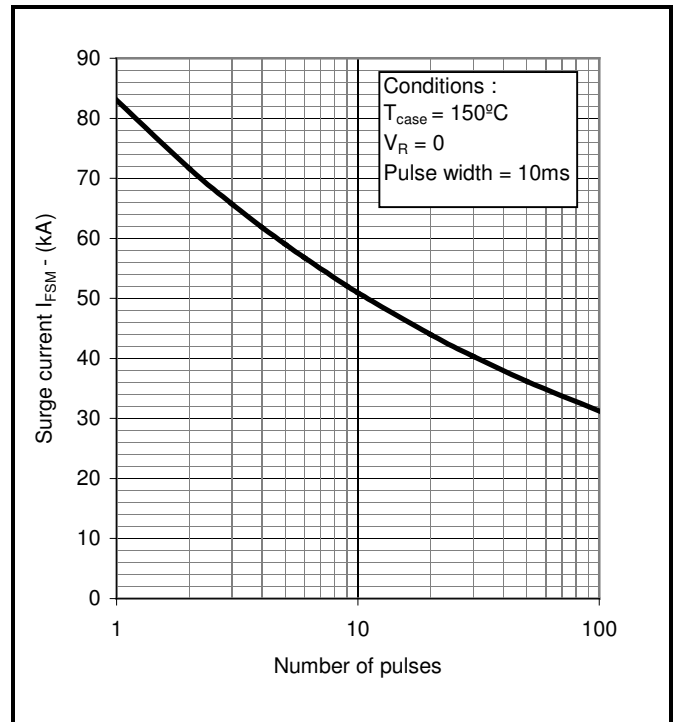

Fig.7 Multi-cycle surge current

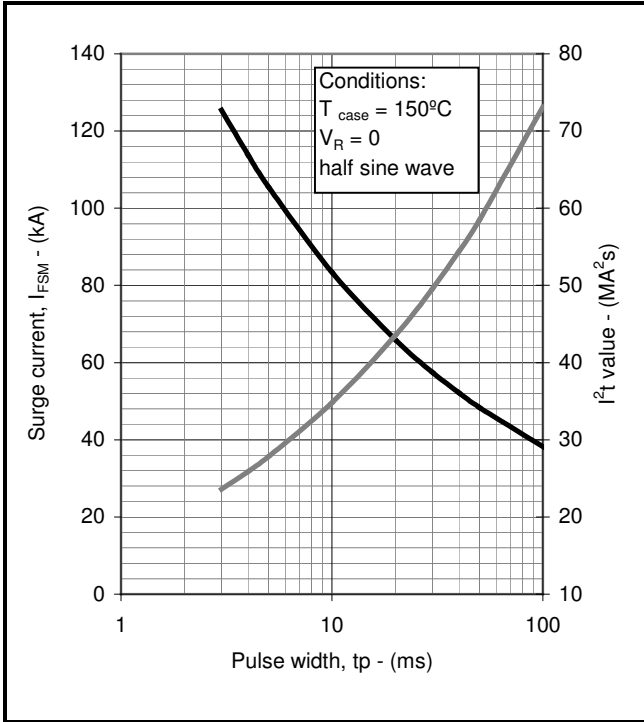
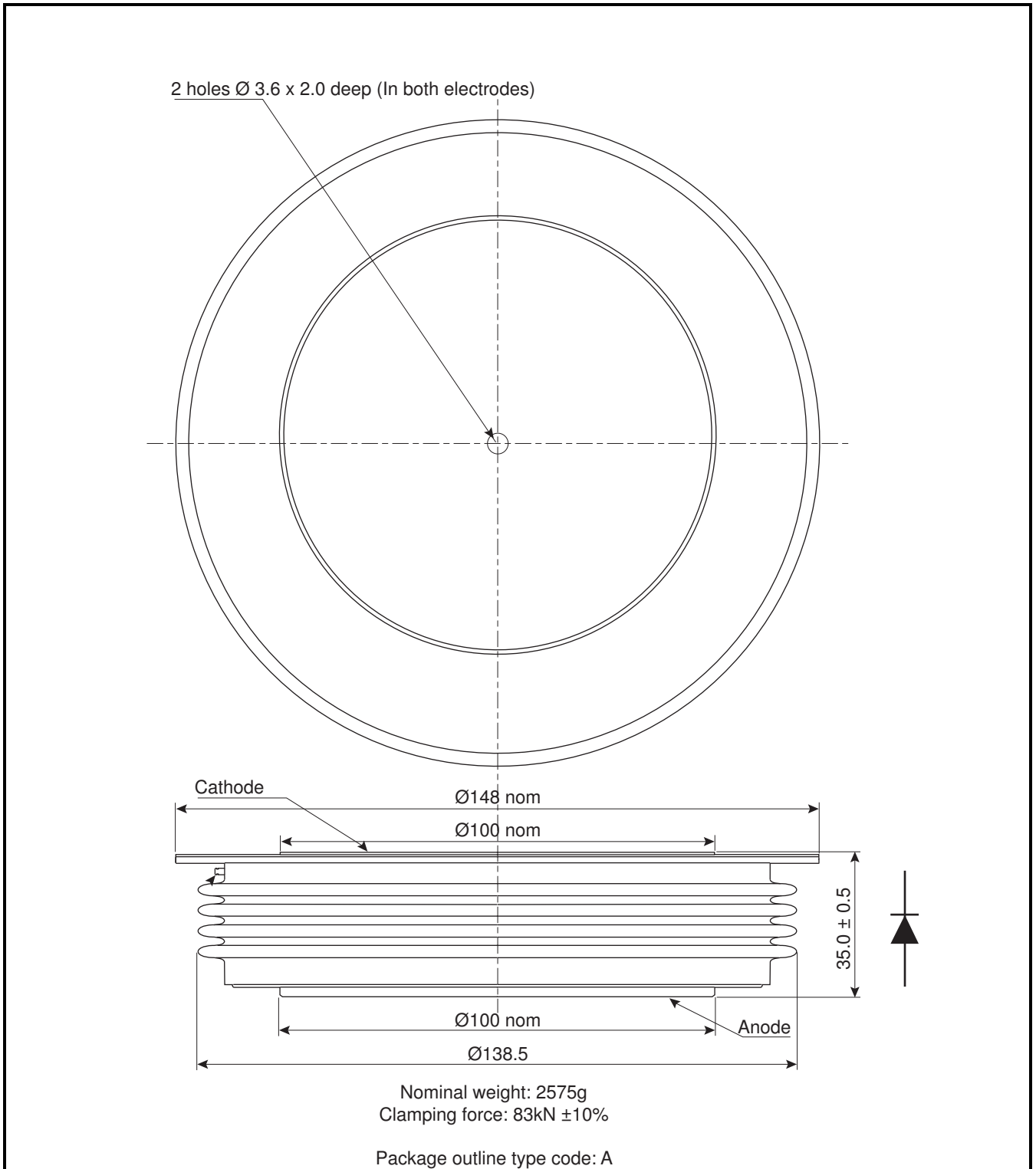

Fig.8 Sub-cycle surge current

PACKAGE DETAILS

For further package information, please contact Customer Services. All dimensions in mm, unless stated otherwise. DO NOT SCALE.



POWER ASSEMBLY CAPABILITY

The Power Assembly group was set up to provide a support service for those customers requiring more than the basic semiconductor, and has developed a flexible range of heatsink and clamping systems in line with advances in device voltages and current capability of our semiconductors.

We offer an extensive range of air and liquid cooled assemblies covering the full range of circuit designs in general use today. The Assembly group offers high quality engineering support dedicated to designing new units to satisfy the growing needs of our customers.

Using the latest CAD methods our team of design and applications engineers aim to provide the Power Assembly Complete Solution (PACs).

HEATSINKS

The Power Assembly group has its own proprietary range of extruded aluminium heatsinks which have been designed to optimise the performance of Dynex semiconductors. Data with respect to air natural, forced air and liquid cooling (with flow rates) is available on request.

For further information on device clamps, heatsinks and assemblies, please contact your nearest sales representative or Customer Services.

Stresses above those listed in this data sheet may cause permanent damage to the device. In extreme conditions, as with all semiconductors, this may include potentially hazardous rupture of the package. Appropriate safety precautions should always be followed.



<http://www.dynexsemi.com>

e-mail: power_solutions@dynexsemi.com

HEADQUARTERS OPERATIONS
DYNEX SEMICONDUCTOR LTD
Doddington Road, Lincoln
Lincolnshire, LN6 3LF. United Kingdom.
Tel: +44(0)1522 500500
Fax: +44(0)1522 500550

CUSTOMER SERVICE
Tel: +44(0)1522 502753 / 502901. Fax: +44(0)1522 500020

© Dynex Semiconductor 2003 TECHNICAL DOCUMENTATION – NOT FOR
RESALE. PRODUCED IN UNITED KINGDOM.

This publication is issued to provide information only which (unless agreed by the Company in writing) may not be used, applied or reproduced for any purpose nor form part of any order or contract nor to be regarded as a representation relating to the products or services concerned. No warranty or guarantee express or implied is made regarding the capability, performance or suitability of any product or service. The Company reserves the right to alter without prior notice the specification, design or price of any product or service. Information concerning possible methods of use is provided as a guide only and does not constitute any guarantee that such methods of use will be satisfactory in a specific piece of equipment. It is the user's responsibility to fully determine the performance and suitability of any equipment using such information and to ensure that any publication or data used is up to date and has not been superseded. These products are not suitable for use in any medical products whose failure to perform may result in significant injury or death to the user. All products and materials are sold and services provided subject to the Company's conditions of sale, which are available on request.

All brand names and product names used in this publication are trademarks, registered trademarks or trade names of their respective owners.