



DS35-B15221

Dx35

MID RANGE DISTANCE SENSORS

SICK
Sensor Intelligence.



Ordering information

Type	Part no.
DS35-B15221	1057655

Other models and accessories → www.sick.com/Dx35



Detailed technical data

Performance

Measuring range	50 mm ... 12,000 mm, 90 % remission ^{1) 2)} 50 mm ... 5,300 mm, 18 % remission 50 mm ... 3,100 mm, 6 % remission
Resolution	0.1 mm
Repeatability	0.5 mm ... 5 mm ^{3) 2) 4)}
Accuracy	Typ. ± 10 mm ⁴⁾
Response time	2.5 ms / 6.5 ms / 12.5 ms / 24.5 ms / 96.5 ms ^{5) 6)}
Switching frequency	333 Hz / 100 Hz / 50 Hz / 25 Hz / 6 Hz ^{5) 6)}
Output time	1 ms/2 ms/4 ms/8 ms/32 ms ^{7) 5)}
Light source	Laser, red ⁸⁾
Laser class	2 (EN 60825-1)
Typ. light spot size (distance)	15 mm x 15 mm (at 2 m)
Additional function	Set speed: Super Fast ... Super Slow, Switching mode: Distance to Object (DtO) / switching window / object between sensor and background (ObSB), teach-in of switching output and switching output invertible, IO-Link, Multifunctional input: laser off / external teach / deactivated, reset to factory default
Laser service life (MTTF at 25 °C)	100,000 h

¹⁾ For speed setting Slow.

²⁾ See characteristic curves repeatability.

³⁾ Equivalent to 1 σ .

⁴⁾ 6 % ... 90 % remission.

⁵⁾ Depending on the set speed: Super Fast ... Super Slow.

⁶⁾ Lateral entry of the object into the measuring range.

⁷⁾ Continuous change of distance in measuring range.

⁸⁾ Wavelength: 658 nm; max. output: 250 mW; pulse duration: 3 ns; duty cycle: 1/250.

Interfaces

Switching output	2 x push-pull: PNP/NPN (100 mA), IO-Link ^{1) 2) 3)}
Multifunctional input (MF)	1 x ⁴⁾
Hysteresis	0 mm ... 11,950 mm ⁵⁾
Data interface	IO-Link

¹⁾ Output Q short-circuit protected.

²⁾ Voltage drop < 3 V.

³⁾ Output Q₂, adaptable: 4 mA ... 20 mA/0 V ... 10 V/switching output/Q₁ not/deactivated.

⁴⁾ Response time ≤ 60 ms.

⁵⁾ Configurable via IO-Link.

Mechanics/electronics

Supply voltage V_s	DC 12 V ... 30 V ^{1) 2)}
Ripple	≤ 5 V _{pp} ³⁾
Power consumption	≤ 1.7 W ^{4) 5)}
Initialization time	≤ 500 ms
Warm-up time	≤ 20 min
Housing material	Plastic (ABS and PC) Acrylic glass (PMMA)
Connection type	Male connector, M12, 5-pin
Indication	LEDs
Weight	65 g

¹⁾ Limit values, reverse-polarity protected, operation in short-circuit protected network: max. 8 A.

²⁾ When using IO-Link output V_s > 18 V.

³⁾ May not fall short of or exceed V_s tolerances.

⁴⁾ At 20 °C.

⁵⁾ Without load.

Ambient data

Enclosure rating	IP 65, IP 67
Protection class	III
Ambient temperature	Operation: -30 °C ... +55 °C ¹⁾ Storage: -40 °C ... +75 °C
Typ. Ambient light immunity	40 klx
Vibration resistance	EN 60068-2-6 / EN 60068-2-64
Shock resistance	EN 60068-2-27

¹⁾ U_v ≤ 24 V.

Dimensional drawing (Dimensions in mm (inch))

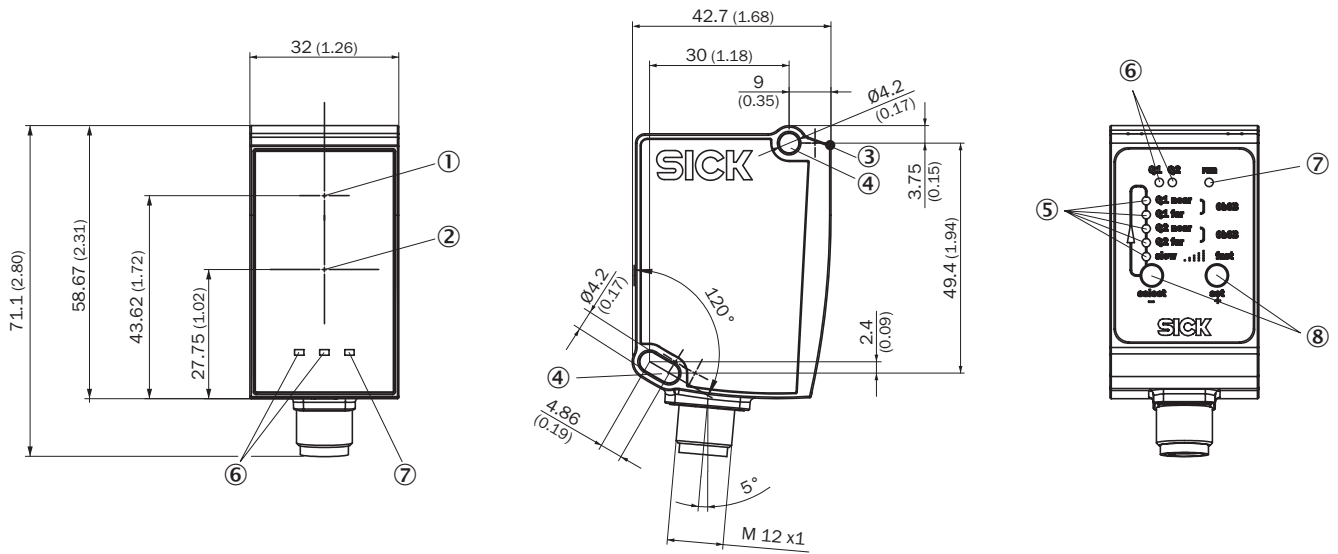

- ① Optical axis, sender
- ② Optical axis, receiver
- ③ Zero level
- ④ Mounting hole M4
- ⑤ Status indicator output Qa/Q2
- ⑥ Status LEDs output Q₁
- ⑦ Operating indicator
- ⑧ Operating elements

Connection type

Male connector M12, 5-pin

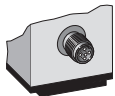

Connection diagram

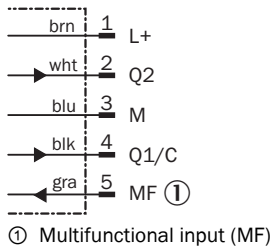

Repeatability

DT35, DS35

Super Slow

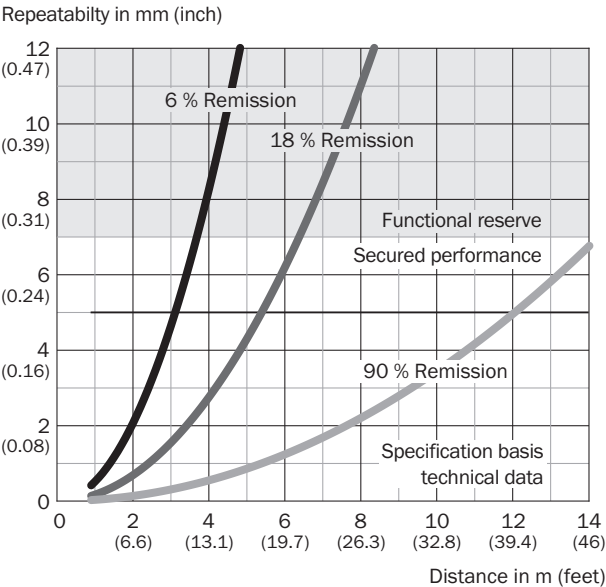

DT35, DS35

Super Fast

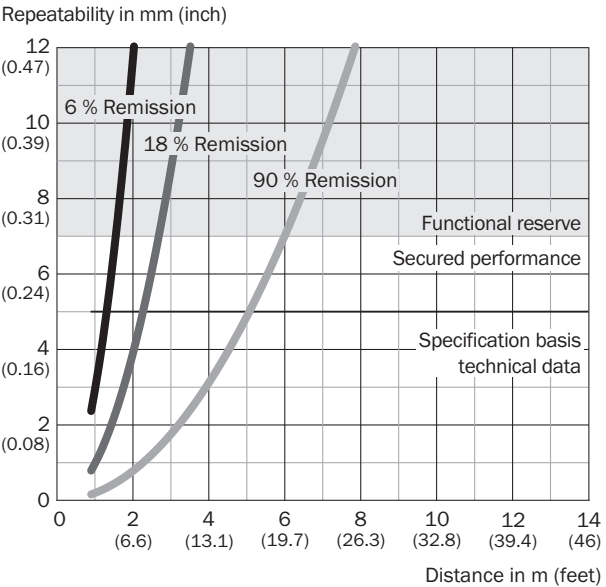

DT35, DS35

Slow

Repeatability in mm (inch)

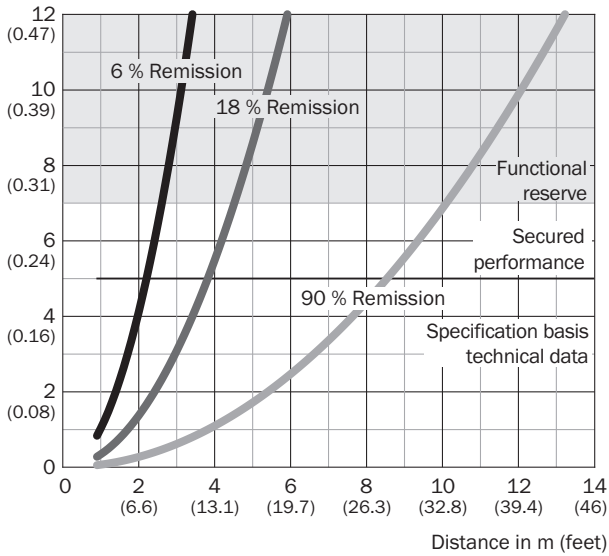

DT35, DS35

Medium

Repeatability in mm (inch)

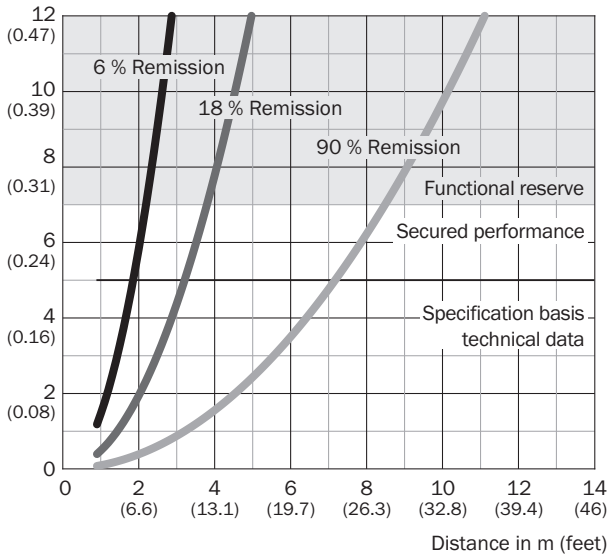

DT35, DS35



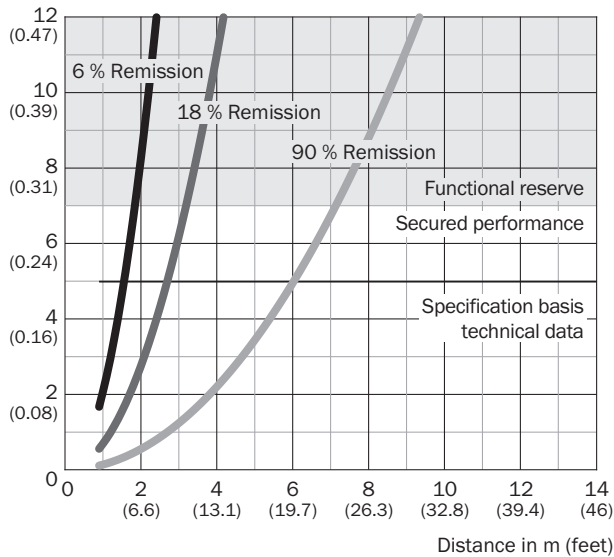

Fast

Repeatability in mm (inch)



Recommended accessories

Other models and accessories → www.sick.com/Dx35

	Brief description	Type	Part no.
Universal bar clamp systems			
	Plate N02 for universal clamp bracket, Zinc plated steel (sheet), Zinc die cast (clamping bracket), Universal clamp (5322626), mounting hardware	BEF-KHS-N02	2051608
Mounting brackets and mounting plates			
	Mounting bracket: horizontal sending axis for ceiling or floor installation or vertical sending axis for wall installation, steel, zinc coated, incl. mounting material, steel, zinc coated, mounting hardware for the sensor included	BEF-WN-DX35	2069592
Terminal and alignment brackets			
	Alignment unit, steel, zinc coated, mounting hardware for the sensor included	BEF-AH-DX50	2048397
Plug connectors and cables			
	Head A: female connector, M12, 5-pin, straight Head B: cable Cable: PVC, unshielded, 2 m	DOL-1205-G02M	6008899
	Head A: female connector, M12, 5-pin, angled Head B: cable Cable: PVC, unshielded, 2 m	DOL-1205-W02M	6008900
	Head A: female connector, M12, 5-pin, straight, A-coded Head B: male connector, M12, 5-pin, straight, A-coded Cable: digital I/Os, drag chain use, PUR, halogen-free, unshielded, 2 m	DSL-1205-G02MC	6025931

SICK AT A GLANCE

SICK is one of the leading manufacturers of intelligent sensors and sensor solutions for industrial applications. A unique range of products and services creates the perfect basis for controlling processes securely and efficiently, protecting individuals from accidents and preventing damage to the environment.

We have extensive experience in a wide range of industries and understand their processes and requirements. With intelligent sensors, we can deliver exactly what our customers need. In application centers in Europe, Asia and North America, system solutions are tested and optimized in accordance with customer specifications. All this makes us a reliable supplier and development partner.

Comprehensive services complete our offering: SICK LifeTime Services provide support throughout the machine life cycle and ensure safety and productivity.

For us, that is “Sensor Intelligence.”

WORLDWIDE PRESENCE:

Contacts and other locations –www.sick.com