

Fast Recovery Epitaxial Diode (FRED)

$I_{FAVM} = 2x30 \text{ A}$
 $V_{RRM} = 1000 \text{ V}$
 $t_{rr} = 35 \text{ ns}$

V_{RSM}	V_{RRM}	Type
V	V	
1000	1000	DSEI 2x 30-10P

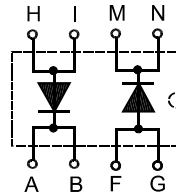

Symbol	Conditions	Maximum Ratings (per diode)	
I_{FRMS}	$T_{VJ} = T_{VJM}$	70	A
I_{FAVM} ①	$T_C = 50^\circ\text{C}$; rectangular; $d = 0.5$	30	A
I_{FRM}	$t_p < 10 \mu\text{s}$; rep. rating; pulse width limited by T_{VJM}	375	A
I_{FSM}	$T_{VJ} = 45^\circ\text{C}$; $t = 10 \text{ ms}$ (50 Hz), sine	200	A
T_{VJ}		-40...+150	$^\circ\text{C}$
T_{VJM}		150	$^\circ\text{C}$
T_{stg}		-40...+150	$^\circ\text{C}$
P_{tot}	$T_C = 25^\circ\text{C}$	100	W
V_{ISOL}	50/60 Hz, RMS	$t = 1 \text{ min}$	2500 V~
	$I_{ISOL} \leq 1 \text{ mA}$	$t = 1 \text{ s}$	3000 V~
M_d	Mounting torque (M4)	1.5 - 2.0	Nm
		14 - 18	lb.in.
Weight		18	g

Features

- 2 independent FRED in 1 package
- Isolation voltage 3000 V~
- Planar passivated chips
- Leads suitable for PC board soldering
- Very short recovery time
- Soft recovery behaviour

Applications

- Antiparallel diode for high frequency switching devices
- Anti saturation diode
- Snubber diode
- Free wheeling diode in converters and motor control circuits
- Rectifiers in switch mode power supplies (SMPS)
- Inductive heating and melting
- Uninterruptible power supplies (UPS)
- Ultrasonic cleaners and welders

Advantages

- Easy to mount with two screws
- Space and weight savings
- Improved temperature and power cycling capability
- Low noise switching
- Small and light weight

Symbol	Conditions	Characteristic Values (per diode)	
		typ.	max.
I_R	$T_{VJ} = 25^\circ\text{C}$ $V_R = V_{RRM}$		750 μA
	$T_{VJ} = 25^\circ\text{C}$ $V_R = 0.8 \cdot V_{RRM}$		250 μA
	$T_{VJ} = 125^\circ\text{C}$ $V_R = 0.8 \cdot V_{RRM}$		7 mA
V_F	$I_F = 30 \text{ A}$; $T_{VJ} = 150^\circ\text{C}$ $T_{VJ} = 25^\circ\text{C}$		2.0 V
			2.4 V
V_{T0}	For power-loss calculations only		1.5 V
r_T	$T_{VJ} = T_{VJM}$		12.5 $\text{m}\Omega$
R_{thJC}			1.25 K/W
R_{thCK}		0.05	K/W
t_{rr}	$I_F = 1 \text{ A}$; $-di/dt = 100 \text{ A}/\mu\text{s}$ $V_R = 30 \text{ V}$; $T_{VJ} = 25^\circ\text{C}$	35	50 ns
I_{RM}	$V_R = 540 \text{ V}$; $I_F = 30 \text{ A}$; $-di_F/dt = 240 \text{ A}/\mu\text{s}$ $L \leq 0.05 \mu\text{H}$; $T_{VJ} = 100^\circ\text{C}$	16	18 A
d_S	Creeping distance on surface	min. 11.2	mm
d_A	Creeping distance in air	min. 11.2	mm
a	Allowable acceleration	max. 50	m/s^2

① I_{FAVM} rating includes reverse blocking losses at T_{VJM} , $V_R = 0.8 V_{RRM}$, duty cycle $d = 0.5$
Data according to IEC 60747

**Recommended replacement:
DSEI 2x31-10P, DSEI 2x31-10B**

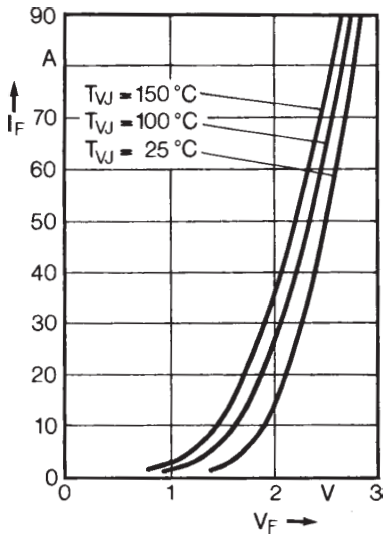

Fig. 1 Forward current versus voltage drop.

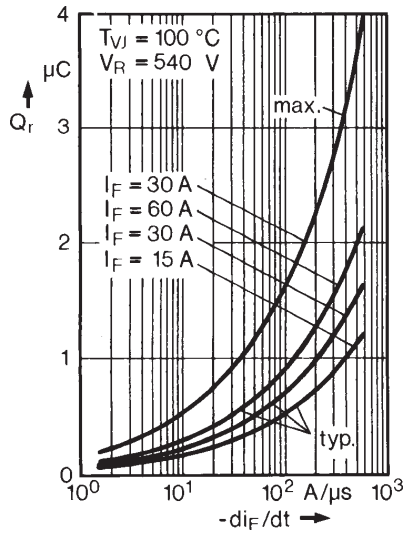

Fig. 2 Recovery charge versus $-di_F/dt$.

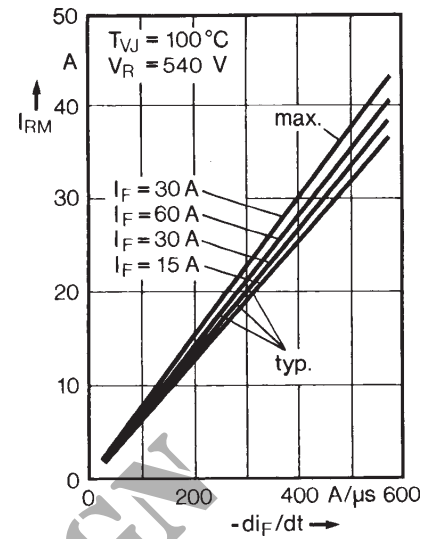

Fig. 3 Peak reverse current versus $-di_F/dt$.

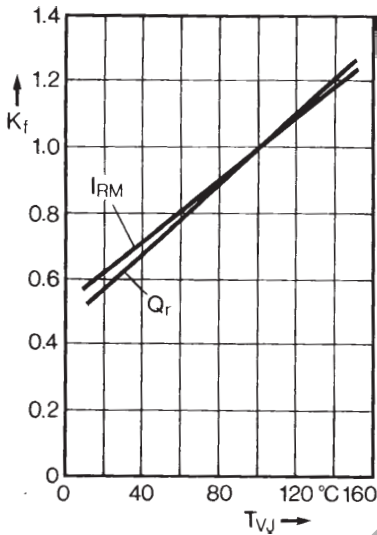

Fig. 4 Dynamic parameters versus junction temperature.

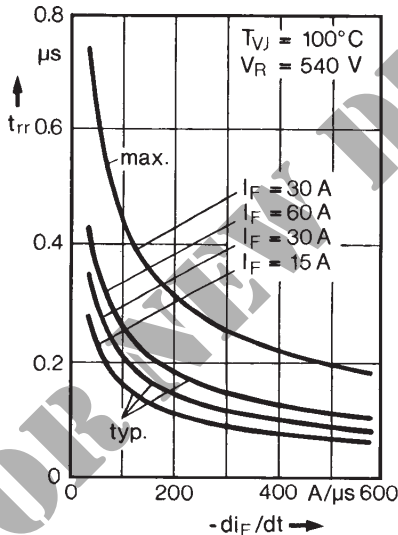

Fig. 5 Recovery time versus $-di_F/dt$.

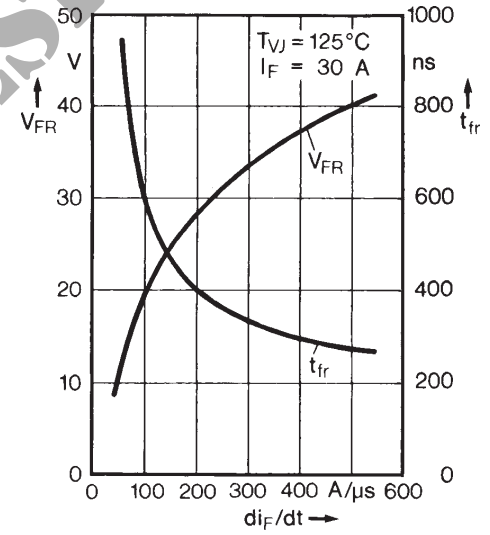

Fig. 6 Peak forward voltage versus di_F/dt .

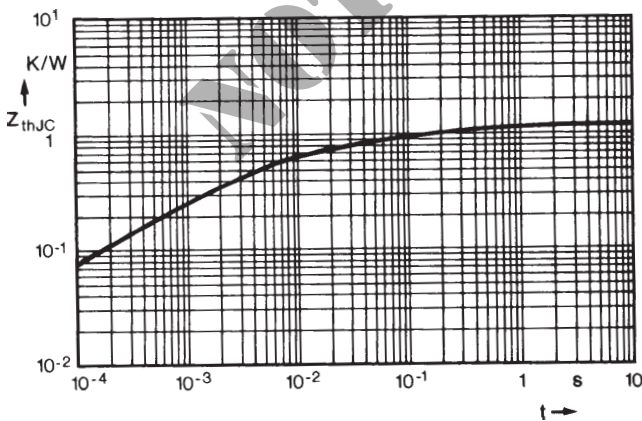

Fig. 7 Transient thermal impedance junction to case.

