



FRED

$V_{RRM} = 1000\text{ V}$
 $I_{FAV} = 30\text{ A}$
 $t_{rr} = 45\text{ ns}$

Fast Recovery Epitaxial Diode Single Diode

Part number

DSEI30-10AR

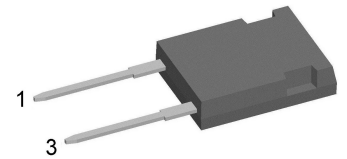

Backside: isolated

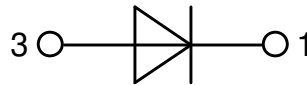

Features / Advantages:

- Planar passivated chips
- Low leakage current
- Very short recovery time
- Improved thermal behaviour
- Very low I_{rm} -values
- Very soft recovery behaviour
- Avalanche voltage rated for reliable operation
- Soft reverse recovery for low EMI/RFI
- Low I_{rm} reduces:
 - Power dissipation within the diode
 - Turn-on loss in the commutating switch

Applications:

- Antiparallel diode for high frequency switching devices
- Antisaturation diode
- Snubber diode
- Free wheeling diode
- Rectifiers in switch mode power supplies (SMPS)
- Uninterruptible power supplies (UPS)

Package: ISOPLUS247

- Isolation Voltage: 3600 V~
- Industry standard outline
- RoHS compliant
- Epoxy meets UL 94V-0
- Soldering pins for PCB mounting
- Backside: DCB ceramic
- Reduced weight
- Advanced power cycling

Disclaimer Notice

Information furnished is believed to be accurate and reliable. However, users should independently evaluate the suitability of and test each product selected for their own applications. Littelfuse products are not designed for, and may not be used in, all applications. Read complete Disclaimer Notice at www.littelfuse.com/disclaimer-electronics.



Fast Diode				Ratings			
Symbol	Definition	Conditions	min.	typ.	max.	Unit	
V_{RSM}	max. non-repetitive reverse blocking voltage	$T_{VJ} = 25^{\circ}C$			1000	V	
V_{RRM}	max. repetitive reverse blocking voltage	$T_{VJ} = 25^{\circ}C$			1000	V	
I_R	reverse current, drain current	$V_R = 1000\text{ V}$	$T_{VJ} = 25^{\circ}C$		750	μA	
		$V_R = 800\text{ V}$	$T_{VJ} = 125^{\circ}C$		7	mA	
V_F	forward voltage drop	$I_F = 30\text{ A}$	$T_{VJ} = 25^{\circ}C$		2.36	V	
		$I_F = 60\text{ A}$			2.67	V	
		$I_F = 30\text{ A}$	$T_{VJ} = 150^{\circ}C$		2.00	V	
		$I_F = 60\text{ A}$			2.50	V	
I_{FAV}	average forward current	$T_C = 70^{\circ}C$ rectangular $d = 0.5$	$T_{VJ} = 150^{\circ}C$		30	A	
V_{FO}	threshold voltage	} for power loss calculation only	$T_{VJ} = 150^{\circ}C$		1.53	V	
r_F	slope resistance				15.5	m Ω	
R_{thJC}	thermal resistance junction to case				1.1	K/W	
R_{thCH}	thermal resistance case to heatsink			0.25		K/W	
P_{tot}	total power dissipation		$T_C = 25^{\circ}C$		115	W	
I_{FSM}	max. forward surge current	$t = 10\text{ ms}; (50\text{ Hz}), \text{ sine}; V_R = 0\text{ V}$	$T_{VJ} = 45^{\circ}C$		200	A	
C_J	junction capacitance	$V_R = 600\text{ V}$ $f = 1\text{ MHz}$	$T_{VJ} = 25^{\circ}C$		16	pF	
I_{RM}	max. reverse recovery current	} $I_F = 30\text{ A}; V_R = 540\text{ V}$ $-di_F/dt = 200\text{ A}/\mu\text{s}$	$T_{VJ} = 25^{\circ}C$		9	A	
			$T_{VJ} = 100^{\circ}C$		13	A	
t_{rr}	reverse recovery time		$T_{VJ} = 25^{\circ}C$		90	ns	
			$T_{VJ} = 100^{\circ}C$		150	ns	



Package ISOPLUS247		Ratings				
Symbol	Definition	Conditions	min.	typ.	max.	Unit
I_{RMS}	RMS current	per terminal			70	A
T_{VJ}	virtual junction temperature		-40		150	°C
T_{op}	operation temperature		-40		125	°C
T_{stg}	storage temperature		-40		150	°C
Weight				6		g
F_C	mounting force with clip		20		120	N
$d_{Spp/ App}$	creepage distance on surface / striking distance through air	terminal to terminal	5.4			mm
$d_{Spb/ Apb}$		terminal to backside	4.1			mm
V_{ISOL}	isolation voltage	t = 1 second t = 1 minute	3600 3000			V
		50/60 Hz, RMS; $I_{ISOL} \leq 1$ mA				

Product Marking

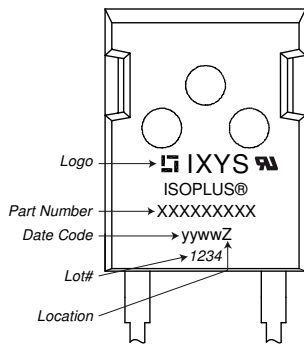

Ordering	Ordering Number	Marking on Product	Delivery Mode	Quantity	Code No.
Standard	DSEI30-10AR	DSEI30-10AR	Tube	30	481947

Similar Part	Package	Voltage class
DSEI30-10A	TO-247AD (2)	1000
DSEI30-12A	TO-247AD (2)	1200

Equivalent Circuits for Simulation

* on die level

$T_{VJ} = 150^{\circ}C$

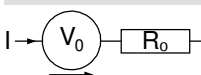

Fast Diode

$V_{0 \max}$	threshold voltage	1.53	V
$R_{0 \max}$	slope resistance *	13	mΩ



Outlines ISOPLUS247

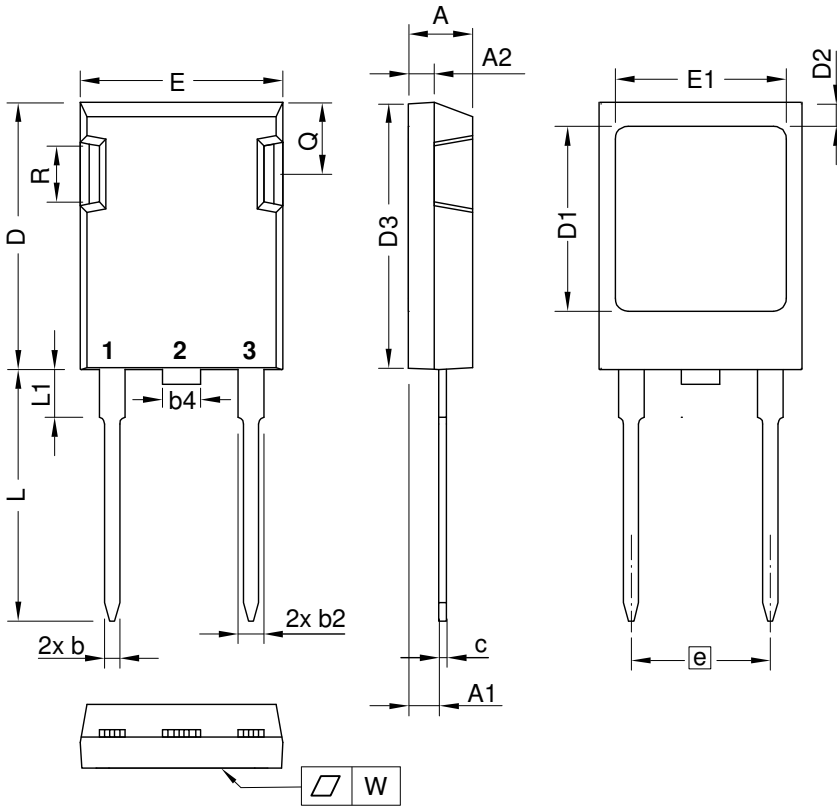

Dim.	Millimeter		Inches	
	min	max	min	max
A	4.83	5.21	0.190	0.205
A1	2.29	2.54	0.090	0.100
A2	1.91	2.16	0.075	0.085
b	1.14	1.40	0.045	0.055
b2	1.91	2.20	0.075	0.087
b4	2.92	3.24	0.115	0.128
c	0.61	0.83	0.024	0.033
D	20.80	21.34	0.819	0.840
D1	15.75	16.26	0.620	0.640
D2	1.65	2.15	0.065	0.085
D3	20.30	20.70	0.799	0.815
E	15.75	16.13	0.620	0.635
E1	13.21	13.72	0.520	0.540
e	10.90 BSC		0.429 BSC	
L	19.81	20.60	0.780	0.811
L1	3.81	4.38	0.150	0.172
Q	5.59	6.20	0.220	0.244
R	4.25	5.50	0.167	0.217
W	-	0.10	-	0.004

Die konvexe Form des Substrates ist typ. < 0.04 mm über der Kunststoffoberfläche der Bauteilunterseite
The convex bow of substrate is typ. < 0.04 mm over plastic surface level of device bottom side

Die Gehäuseabmessungen entsprechen dem Typ TO-247 AD gemäß JEDEC außer Schraubloch und L_{max} .
This drawing will meet all dimensions requirement of JEDEC outline TO-247 AD except screw hole and except L_{max} .

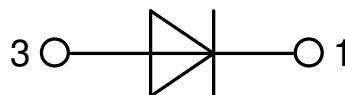

Fast Diode

 Fig. 1 Forward current I_F versus max. forward voltage drop V_F

 Fig. 2 Typ. reverse recov. charge Q_r versus $-di_F/dt$

 Fig. 3 Typ. peak reverse current I_{RM} versus $-di_F/dt$

 Fig. 4 Dynamic parameters Q_r , I_{RM} versus T_{VJ}

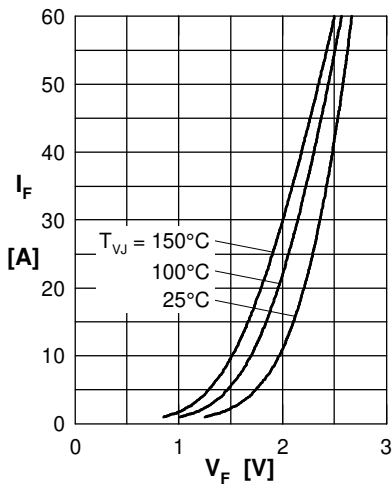
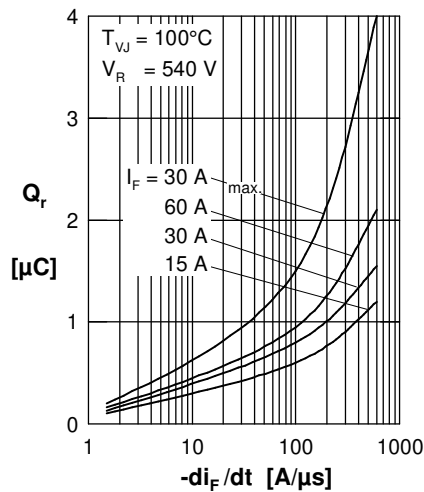
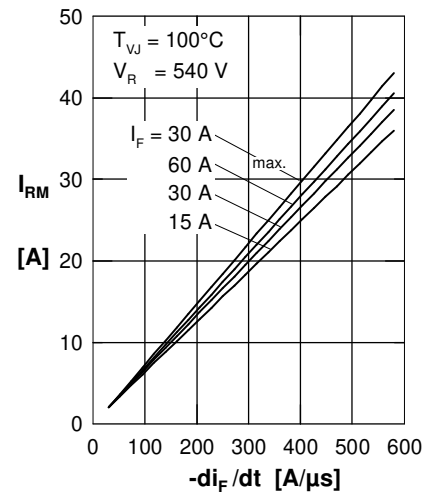
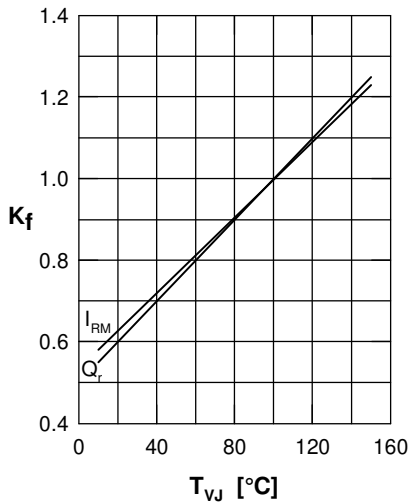
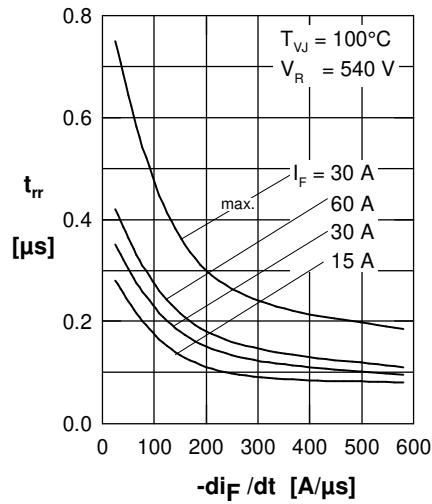
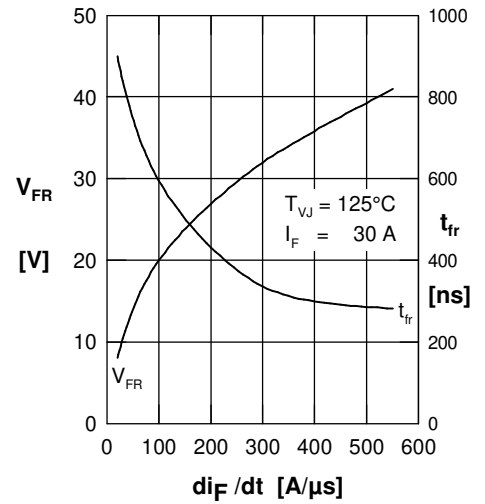
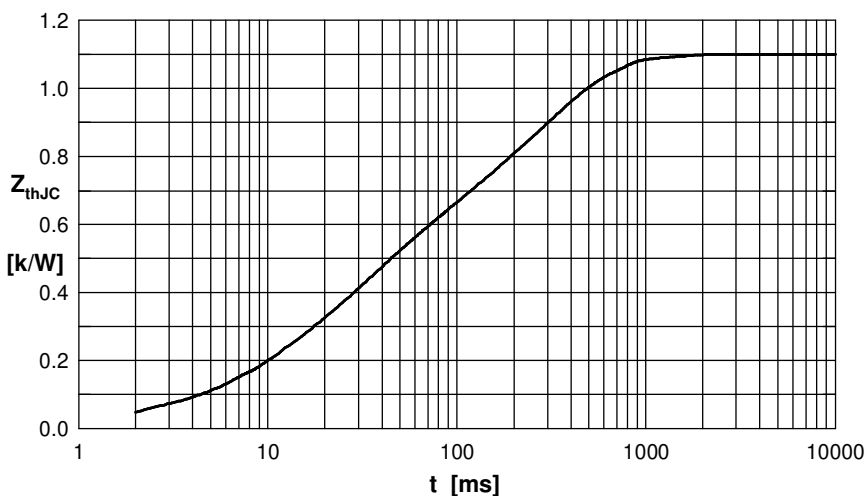
 Fig. 5 Typ. recovery time t_{rr} versus $-di_F/dt$

 Fig. 6 Typ. peak forward voltage V_{FR} and t_{fr} versus di_F/dt

Fig. 7 Transient thermal impedance junction to case

 Constants for Z_{thJC} calculation:

i	R_{thi} (K/W)	t_i (s)
1	0.030	0.0100
2	0.100	0.0120
3	0.360	0.0300
4	0.610	0.2700