

DSP1 SERIES DUAL OUTPUT

DESCRIPTION

The DSP1 Series is specifically designed to convert a nominal 5 volt input into two isolated output voltages. The dual semi-regulated output voltages are designed to allow analog circuits and three terminal regulators to operate within their most efficient input voltage range. This series achieves high power densities through the use of 350KHz fixed frequency switching converters.

FEATURES

- Up to 1 Watt Unregulated Output Power
- Single In Line Package
- Four Terminal Operation
- Efficiencies to 70%
- Output Voltages: 5V, 7V, 12V, 14V, 15V, 17V
- 700V Isolation
- -40°C to +85°C Operation

Selection Chart					
Model	Input Range VDC		Output VDC	Output mA	Power W
	Min	Max			
DSP1N5D5	4.5	5.5	±5	±75	0.75
DSP1N5D7	4.5	5.5	±7	±70	1
DSP1N5D12	4.5	5.5	±12	±40	1
DSP1N5D14	4.5	5.5	±14	±35	1
DSP1N5D15	4.5	5.5	±15	±33	1
DSP1N5D17	4.5	5.5	±17	±30	1

General Specifications (1)				
All Models				Units
Isolation				
Isolation Voltage	MIN	500	VDC	
Input to Output Capacitance	TYP	10	pF	
Environmental				
Case Operating Range, Tc (2)	MIN MAX	-40 +85	° C	
Storage Range	MIN MAX	-55 105	° C	
Line Regulation	TYP	1	%	
Load Regulation 20% to 100% Load	TYP	5	%	
General				
MTBF (Calculated)	TYP	700,000	HRS	
Unit Weight	TYP	0.1/28	oz/gm	
Case Material	Non Conductive Plastic			

NOTES

- (1) All parameters measured at Tc=25 °C case temperature, nominal input voltage and full rated load unless otherwise noted.
- (2) Derate output power linearly to 0.6 watts from 70°C to 85°C.

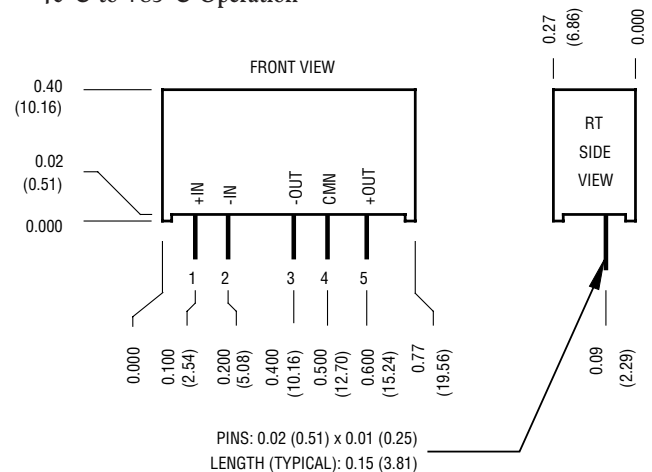

Mechanical tolerances unless otherwise noted:

X.XX dimensions: ±0.020 inches

X.XXX dimensions: ±0.010 inches

Pin	Function
1	+INPUT
2	-INPUT
3	-OUT
4	COMMON
5	+OUT

DSP1 SERIES APPLICATION NOTES:

External Capacitance Requirements

Output filtering is required for operation. A minimum of 10µF is specified for optimal performance. Output capacitance may be increased for additional filtering, and should not exceed 400µF. To meet the reflected ripple requirements of the converter, an input impedance of less than 0.5 Ohms from DC to 350KHz is required. If a capacitive input source is farther than 2" from the converter, it is recommended to use a 10µF, 25V solid tantalum capacitor.

Regulation

This converter uses a semi-regulated design. The output will vary as the load is changed, with output decreasing with increasing load. Additionally, output voltage will change in proportion to a change in input voltage. The typical output voltage will change 1% for each 1% change in input voltage.

DSP1 SERIES – DUAL OUTPUT

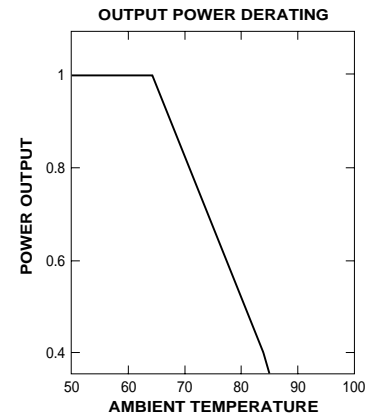
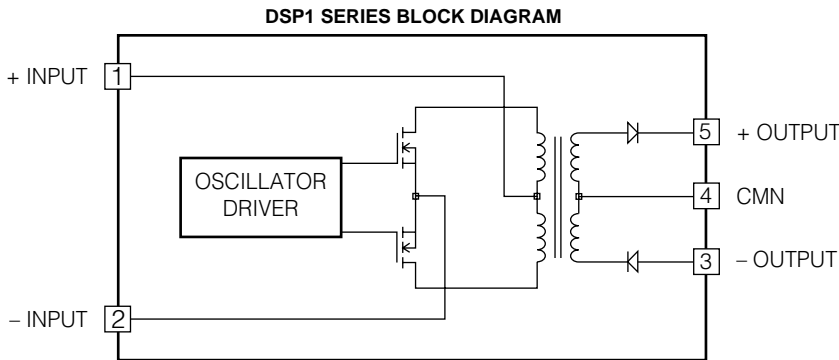

Typical Performance: (Tc=25°C)

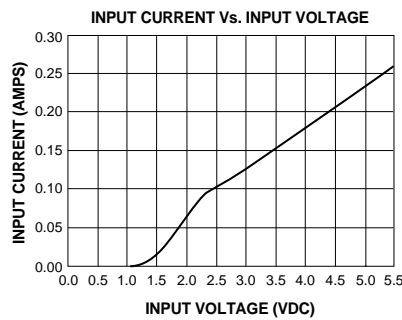
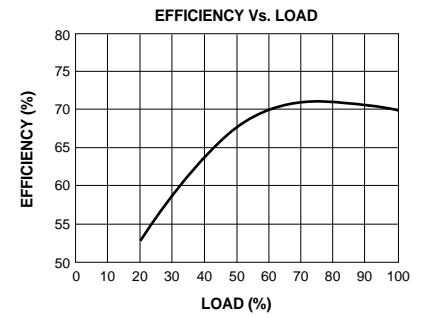
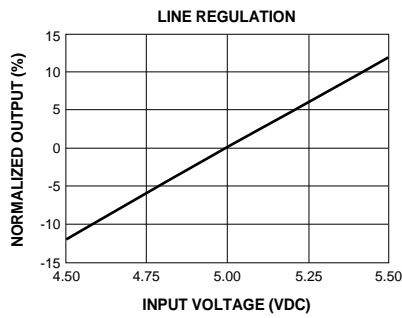
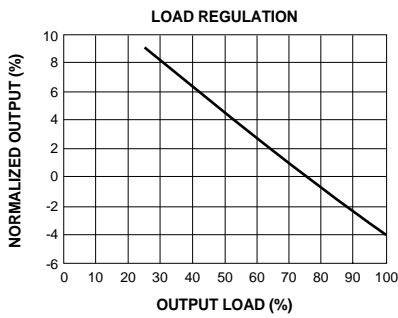

For the Most Up-To-Date Information

www.power-one.com

24 Hours/Day—7 Days/Week



NUCLEAR AND MEDICAL APPLICATIONS Power-One products are not authorized for use as critical components in life support systems, equipment used in hazardous environments, or nuclear control systems without the express written consent of the President of Power-One, Inc.

TECHNICAL REVISIONS The appearance of products, including safety agency certifications pictured on labels, may change depending on the date manufactured. Specifications are subject to change without notice.