

# Standard Rectifier

$$V_{RRM} = 2 \times 1600 \text{ V}$$

$$I_{FAV} = 45 \text{ A}$$

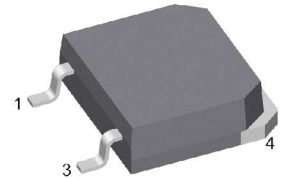
$$V_F = 1.23 \text{ V}$$

Phase leg

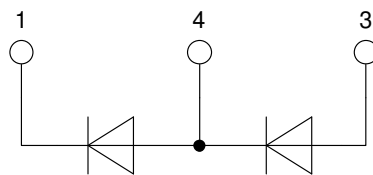
Part number

**DSP45-16AZ**

Marking on Product: DSP45-16AZ



Backside: anode/cathode



### Features / Advantages:

- Planar passivated chips
- Very low leakage current
- Very low forward voltage drop
- Improved thermal behaviour

### Applications:

- Diode for main rectification
- For single and three phase bridge configurations

### Package: TO-268AA (D3Pak-HV)

- Industry standard outline
- RoHS compliant
- Epoxy meets UL 94V-0

### Disclaimer Notice

Information furnished is believed to be accurate and reliable. However, users should independently evaluate the suitability of and test each product selected for their own applications. Littelfuse products are not designed for, and may not be used in, all applications. Read complete Disclaimer Notice at [www.littelfuse.com/disclaimer-electronics](http://www.littelfuse.com/disclaimer-electronics).

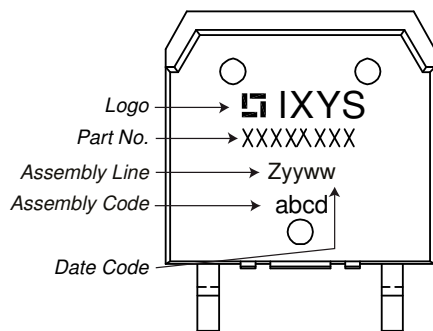


Rectifier				Ratings			
Symbol	Definition	Conditions	min.	typ.	max.	Unit	
$V_{RSM}$	max. non-repetitive reverse blocking voltage				1700	V	
$V_{RRM}$	max. repetitive reverse blocking voltage				1600	V	
$I_R$	reverse current	$V_R = 1600$ V			40	$\mu$ A	
		$V_R = 1600$ V			1.5	mA	
$V_F$	forward voltage drop	$I_F = 45$ A			1.26	V	
		$I_F = 90$ A			1.52	V	
		$I_F = 45$ A	$T_{VJ} = 150^\circ\text{C}$			1.23	V
		$I_F = 90$ A				1.57	V
$I_{FAV}$	average forward current	$T_C = 130^\circ\text{C}$ 180° sine			45	A	
$V_{F0}$	threshold voltage	} for power loss calculation only			0.86	V	
$r_F$	slope resistance				7.8	m $\Omega$	
$R_{thJC}$	thermal resistance junction to case				0.55	K/W	
$R_{thCH}$	thermal resistance case to heatsink			0.15		K/W	
$P_{tot}$	total power dissipation				270	W	
$I_{FSM}$	max. forward surge current	t = 10 ms; (50 Hz), sine	$T_{VJ} = 45^\circ\text{C}$		480	A	
		t = 8,3 ms; (60 Hz), sine	$V_R = 0$ V		520	A	
		t = 10 ms; (50 Hz), sine	$T_{VJ} = 150^\circ\text{C}$		410	A	
		t = 8,3 ms; (60 Hz), sine	$V_R = 0$ V		440	A	
$I^2t$	value for fusing	t = 10 ms; (50 Hz), sine	$T_{VJ} = 45^\circ\text{C}$		1.15	kA <sup>2</sup> s	
		t = 8,3 ms; (60 Hz), sine	$V_R = 0$ V		1.13	kA <sup>2</sup> s	
		t = 10 ms; (50 Hz), sine	$T_{VJ} = 150^\circ\text{C}$		840	A <sup>2</sup> s	
		t = 8,3 ms; (60 Hz), sine	$V_R = 0$ V		805	A <sup>2</sup> s	
$C_J$	junction capacitance	$V_R = 400$ V; f = 1 MHz	$T_{VJ} = 25^\circ\text{C}$		19	pF	



Package TO-268AA (D3Pak-HV)			Ratings			
Symbol	Definition	Conditions	min.	typ.	max.	Unit
$I_{RMS}$	RMS current	per terminal			70	A
$T_{VJ}$	virtual junction temperature		-40		175	°C
$T_{op}$	operation temperature		-40		150	°C
$T_{stg}$	storage temperature		-40		150	°C
<b>Weight</b>				4		g
$F_C$	mounting force with clip		20		120	N
$d_{Spp/App}$	creepage distance on surface / striking distance through air	terminal to terminal	9.4			mm
$d_{Spb/Apb}$		terminal to backside	5.6			mm

**Product Marking**



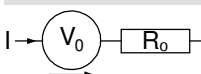
Ordering	Ordering Number	Marking on Product	Delivery Mode	Quantity	Code No.
Standard	DSP45-16AZ-TUB	DSP45-16AZ	Tube	30	514141

Similar Part	Package	Voltage class
DSP45-12AZ	TO-268AA (D3Pak) (2HV)	1200
DSP45-12A	TO-247AD (3)	1200
DSP45-16A	TO-247AD (3)	1600
DSP45-16AR	ISOPLUS247 (3)	1600
DSP45-18A	TO-247AD (3)	1800

**Equivalent Circuits for Simulation**

\* on die level

$T_{VJ} = 175\text{ °C}$

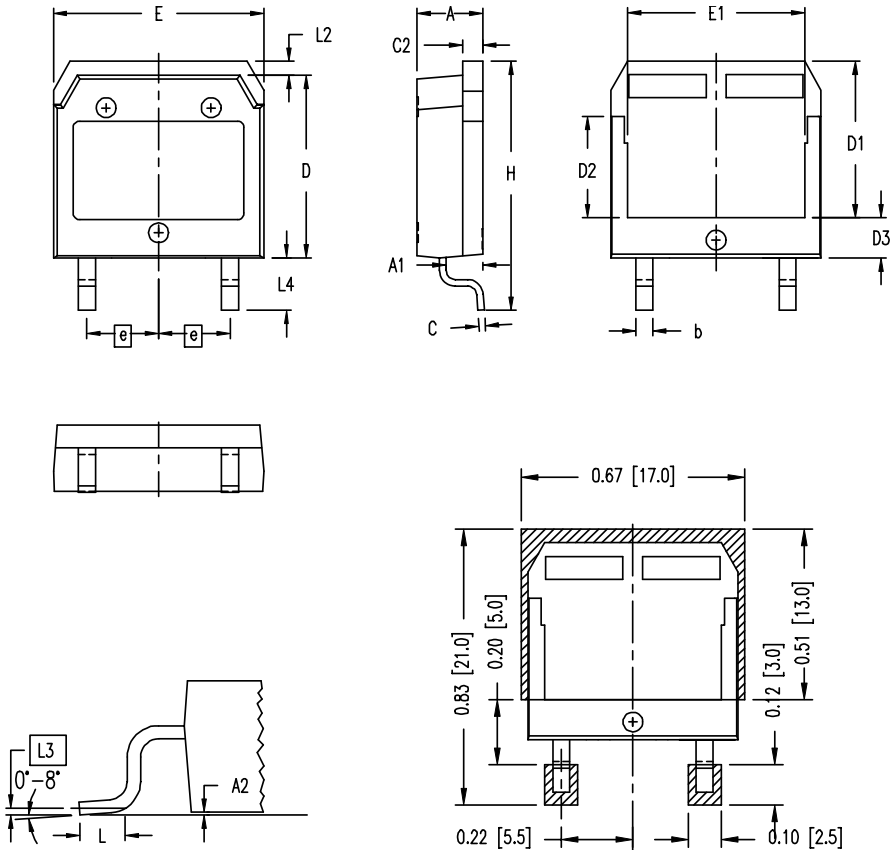


**Rectifier**

$V_{0\ max}$	threshold voltage	0.86	V
$R_{0\ max}$	slope resistance *	6.5	mΩ

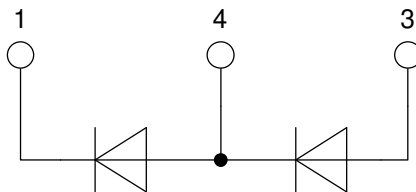


**Outlines TO-268AA (D3Pak-HV)**



Dim.	Millimeter		Inches	
	min	max	min	max
A	4.90	5.10	0.193	0.201
A1	2.70	2.90	0.106	0.114
A2	0.02	0.25	0.001	0.010
b	1.15	1.45	0.045	0.057
C	0.40	0.65	0.016	0.026
C2	1.45	1.60	0.057	0.063
D	13.80	14.00	0.543	0.551
D1	11.80	12.10	0.465	0.476
D2	7.50	7.80	0.295	0.307
D3	2.90	3.20	0.114	0.126
E	15.85	16.05	0.624	0.632
E1	13.30	13.60	0.524	0.535
e	5.450 BSC		0.215 BSC	
H	18.70	19.10	0.736	0.752
L	1.70	2.00	0.067	0.079
L2	1.00	1.15	0.039	0.045
L3	0.250 BSC		0.010 BSC	
L4	3.80	4.10	0.150	0.161

**RECOMMENDED MINIMUM FOOT PRINT**



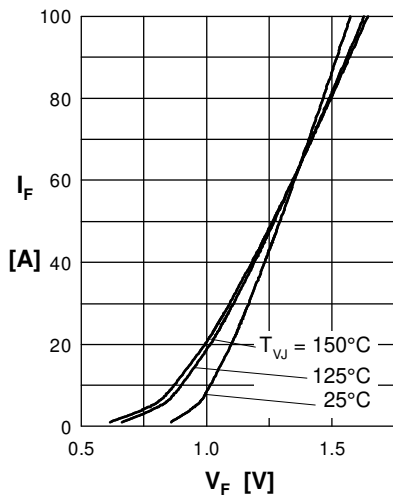
**Rectifier**


Fig. 1 Forward current versus voltage drop per diode

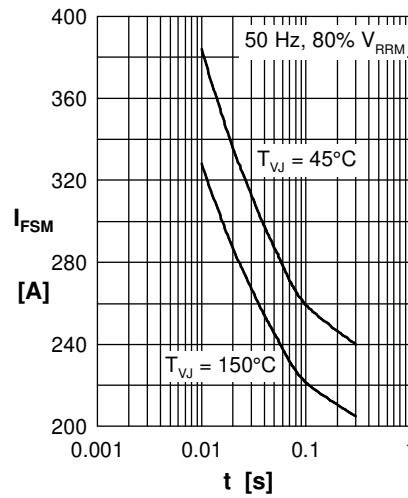


Fig. 2 Surge overload current

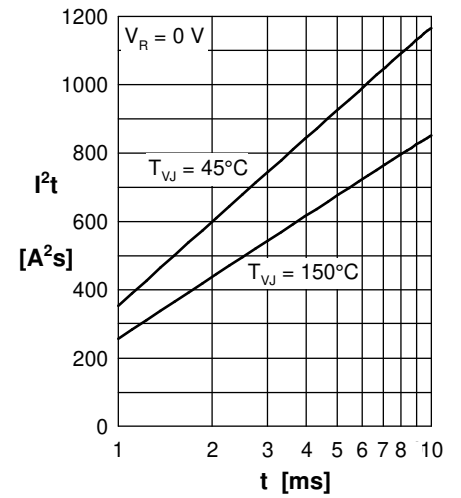
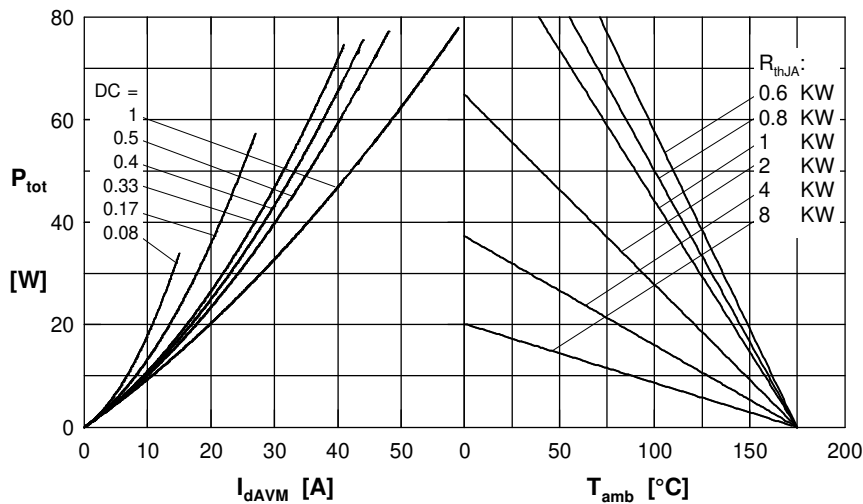

 Fig. 3  $I^2t$  versus time per diode


Fig. 4 Power dissipation vs. direct output current &amp; ambient temperature

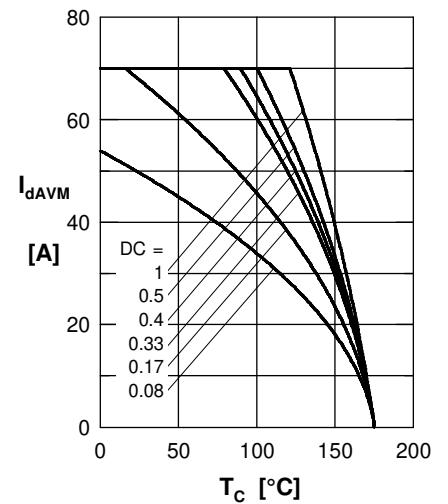


Fig. 5 Max. forward current vs. case temperature

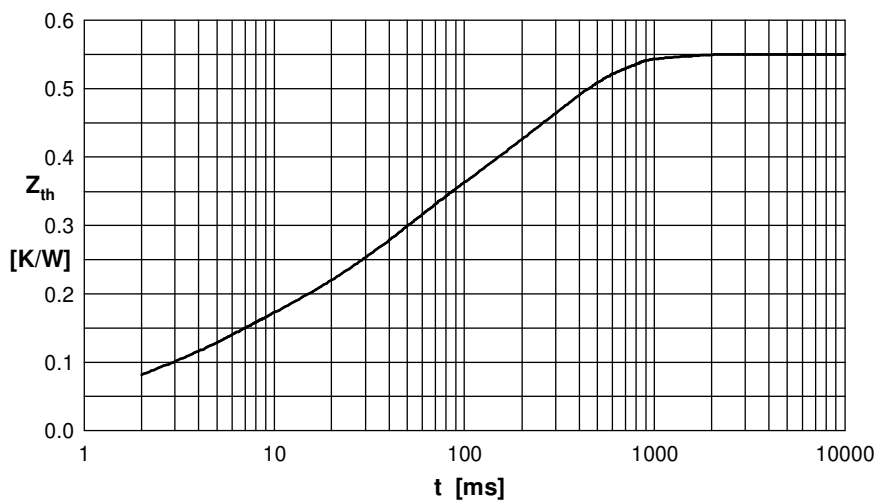


Fig. 6 Transient thermal impedance junction to case

i	R <sub>i</sub>	t <sub>i</sub>
1	0.033	0.0006
2	0.095	0.0039
3	0.164	0.033
4	0.258	0.272