



DTB113Z

PNP SILICON TRANSISTOR

DIGITAL TRANSISTOR (BUILT-IN RESISTORS)

■ FEATURES

- * Built-in Bias Resistors that Implies Easy ON/OFF Applications.
- * The Bias Resistors Are Thin-Film Resistors with Complete Isolation to Allow Positive Input.

■ EQUIVALENT CIRCUIT

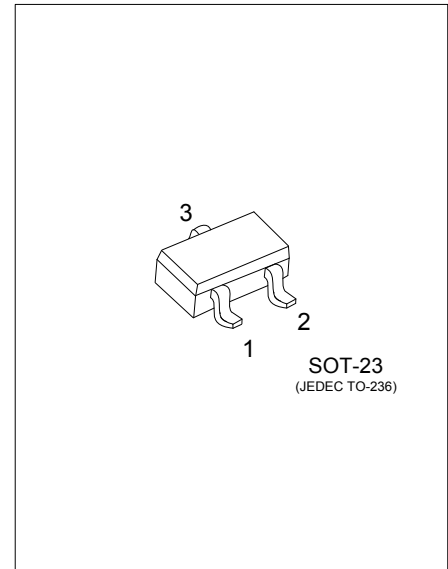
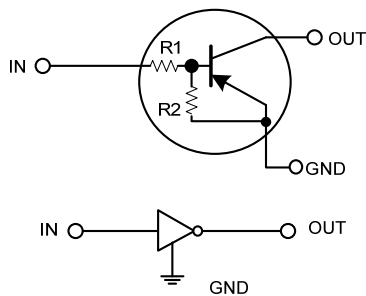

SOT-23
(JEDEC TO-236)

■ ORDERING INFORMATION

Order Number		Package	Pin Assignment			Packing
Lead Free	Halogen Free		1	2	3	
DTB113ZL-AE3-R	DTB113ZG-AE3-R	SOT-23	I	G	O	Tape Reel

Note: Pin Assignment: I: IN G: GND O: OUT

DTB113ZG-AE3-R	(1)Packing Type (2)Package Type (3)Green Package	(1) R: Tape Reel (2) AE3: SOT-23 (3) G: Halogen Free and Lead Free, L: Lead Free
----------------	--	--

■ MARKING

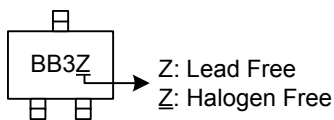

■ ABSOLUTE MAXIMUM RATING ($T_A=25^{\circ}\text{C}$, unless otherwise specified)

PARAMETER	SYMBOL	RATINGS	UNIT
Supply Voltage	V_{CC}	-50	V
Input Voltage	V_{IN}	-10 ~ +5	V
Output Current	I_C	-500	mA
Power Dissipation	P_D	200	mW
Junction Temperature	T_J	+150	$^{\circ}\text{C}$
Storage Temperature	T_{STG}	-55 ~ +150	$^{\circ}\text{C}$

Note: Absolute maximum ratings are those values beyond which the device could be permanently damaged. Absolute maximum ratings are stress ratings only and functional device operation is not implied.

■ ELECTRICAL CHARACTERISTICS ($T_A=25^{\circ}\text{C}$, unless otherwise specified)

PARAMETER	SYMBOL	TEST CONDITIONS	MIN	TYP	MAX	UNIT
Input Voltage	$V_{IN(OFF)}$	$V_{CC} = -5\text{V}, I_{OUT} = -100\mu\text{A}$			-0.3	V
	$V_{IN(ON)}$	$V_{OUT} = -0.3\text{V}, I_{OUT} = -20\text{mA}$	-3			
Output Voltage	$V_{OUT(ON)}$	$I_{OUT}/I_{IN} = -50\text{mA}/-2.5\text{mA}$			-0.3	V
Input Current	I_{IN}	$V_{IN} = -5\text{V}$			-7.2	mA
Output Current	$I_{OUT(OFF)}$	$V_{CC} = -50\text{V}, V_{IN} = 0\text{V}$			-0.5	μA
DC Current Gain	h_{FE}	$V_{OUT} = -5\text{V}, I_{OUT} = -50\text{mA}$	56			
Input Resistance	R_1		0.7	1	1.3	$\text{K}\Omega$
Resistance Ratio	R_2/R_1		8	10	12	
Transition Frequency	f_T	$V_{CE} = -10\text{V}, I_E = 50\text{mA}, f = 100\text{MHz}(\text{Note})$		200		MHz

Note: Transition frequency of the device

■ TYPICAL CHARACTERISTICS

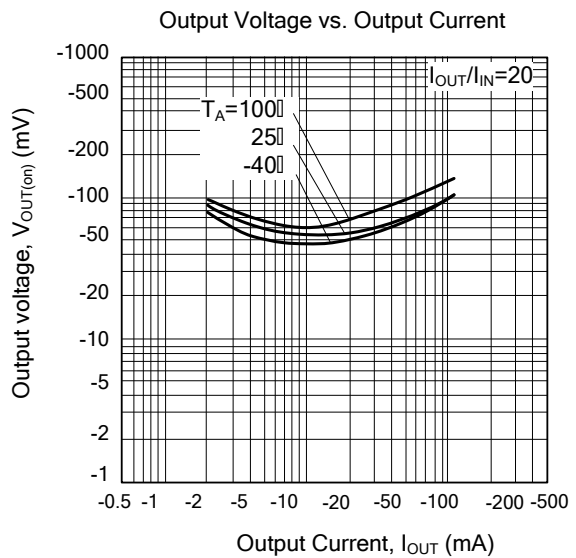
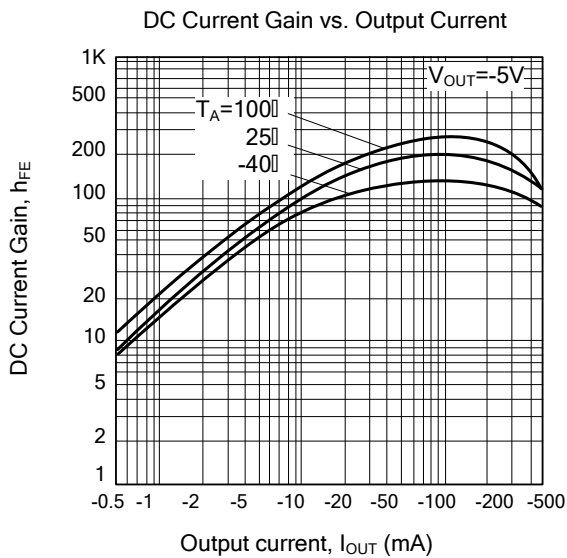
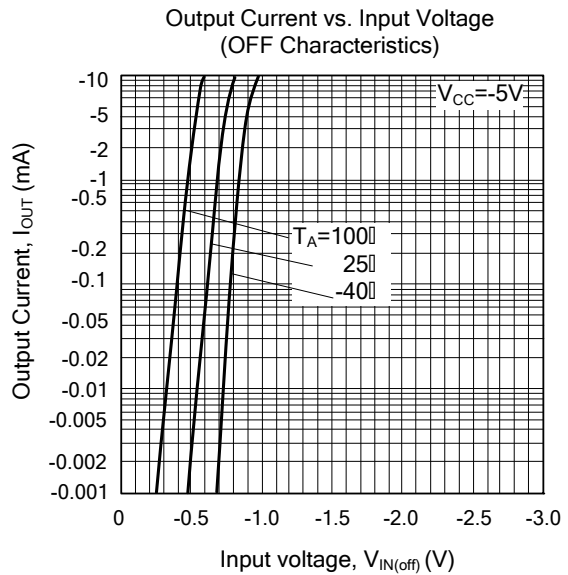
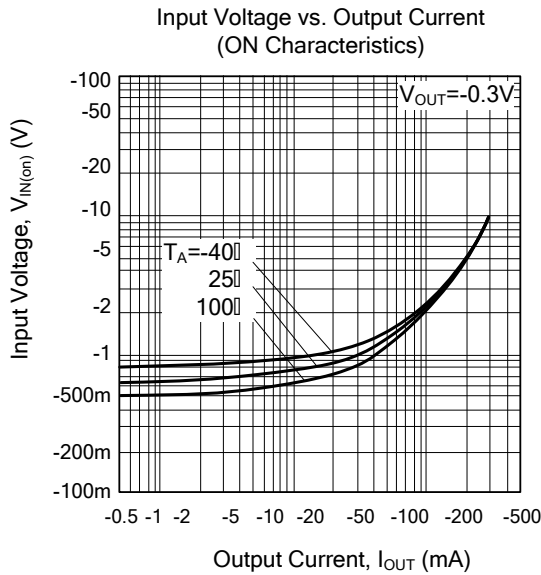

UTC assumes no responsibility for equipment failures that result from using products at values that exceed, even momentarily, rated values (such as maximum ratings, operating condition ranges, or other parameters) listed in products specifications of any and all UTC products described or contained herein. UTC products are not designed for use in life support appliances, devices or systems where malfunction of these products can be reasonably expected to result in personal injury. Reproduction in whole or in part is prohibited without the prior written consent of the copyright owner. UTC reserves the right to make changes to information published in this document, including without limitation specifications and product descriptions, at any time and without notice. This document supersedes and replaces all information supplied prior to the publication hereof.