

FEATURES

- * Built-in bias resistors enable the configuration of an inverter circuit without connecting external input resistors (see equivalent circuit).
- * Only the on/off conditions need to be set for operation making device design easy.
- * The bias resistors consist of thin-film resistors with complete isolation to allow negative biasing of the input. They also have the advantage of almost completely eliminating parasitic effects.

●Equivalent circuit

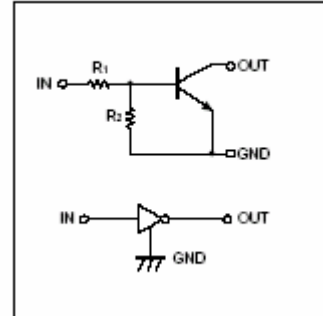

Pin Connections And Marking

DTC113ZE

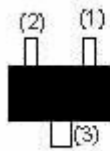

1.IN
2.GND
3.OUT

SOT-523

Abbreviated symbol: E21

DTC113ZUA

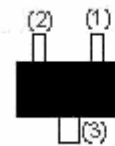

1.IN
2.GND
3.OUT

SOT-323

Abbreviated symbol: E21

DTC113ZKA

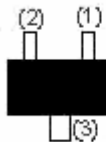

1.IN
2.GND
3.OUT

SOT-23
SOT-23-3L

Abbreviated symbol: E21

DTC113ZCA



1.IN
2.GND
3.OUT

SOT-23

Abbreviated symbol: E21

DTC113ZSA

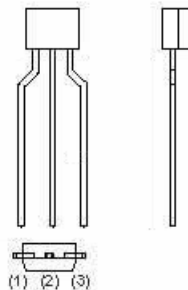

1.GND
2.OUT
3.IN

TO-92S

Absolute maximum ratings(Ta=25°C)

Parameter	Symbol	Limits (DTC113Z□)					Unit
		E	UA	CA	KA	SA	
Supply voltage	V _{CC}	50					V
Input voltage	V _{IN}	-5~+10					V
Output current	I _O	100					mA
	I _{C(MAX)}	100					
Power dissipation	P _d	150		200		300	mW
Junction temperature	T _j	150					°C
Storage temperature	T _{stg}	-55~150					°C

Electrical characteristics (Ta=25°C)

Parameter	Symbol	Min.	Typ	Max.	Unit	Conditions
Input voltage	V _{I(off)}			0.3	V	V _{CC} =5V, I _O =100μA
	V _{I(on)}	3				V _O =0.3V, I _O =20 mA
Output voltage	V _{O(on)}			0.3	V	I _O /I _I =10mA/0.5mA
Input current	I _I			7.2	mA	V _I =5V
Output current	I _{O(off)}			0.5	μA	V _{CC} =50V, V _I =0
DC current gain	G _I	33				V _O =5V, I _O =5mA
Input resistance	R ₁	0.7	1	1.3	KΩ	
Resistance ratio	R ₂ /R ₁	8	10	12		
Transition frequency	f _T		250		MHz	V _{CE} =10V, I _E =-5mA, f=100MHz

Typical Characteristics

● Electrical characteristic curves

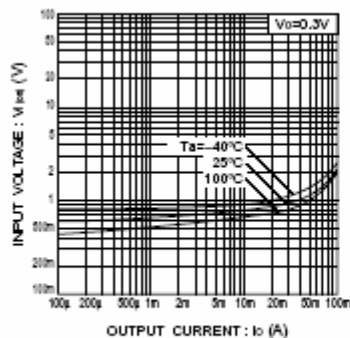

Fig.1 Input voltage vs. output current (ON characteristics)

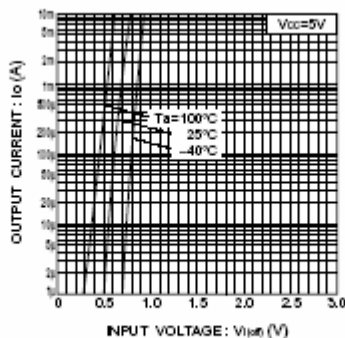

Fig.2 Output current vs. input voltage (OFF characteristics)

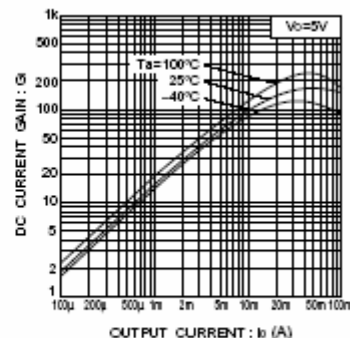

Fig.3 DC current gain vs. output current

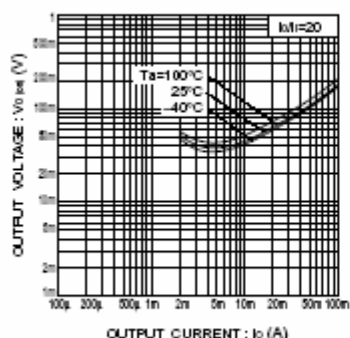

Fig.4 Output voltage vs. output current