

RoHS Compliant Product
A suffix of "-C" specifies halogen & lead-free

FEATURES

- Built-in bias resistors enable the configuration of an inverter circuit without connecting external input resistors (see equivalent circuit).
- The bias resistors consist of thin-film resistors with complete isolation to allow positive biasing of the input. They also have the advantage of almost completely eliminating parasitic effects.
- Only the on/off conditions need to be set for operation, making device design easy.

EQUIVALENT CIRCUIT

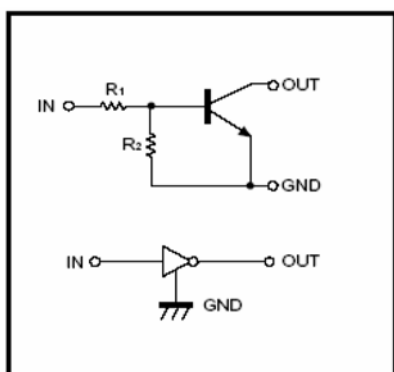

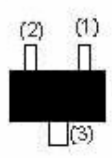
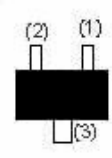
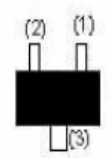
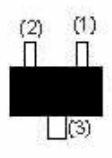
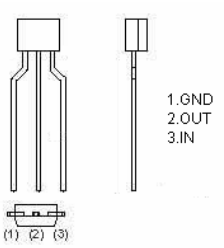
<p>DTC114EE (SOT-523)</p>  <p>1.IN 2.GND 3.OUT</p> <p>Abbreviated symbol : 24</p>	<p>DTC114EUA (SOT-323)</p>  <p>1.IN 2.GND 3.OUT</p> <p>Abbreviated symbol : 24</p>
<p>DTC114EM (SOT-723)</p>  <p>1.IN 2.GND 3.OUT</p> <p>Abbreviated symbol : 24</p>	<p>DTC114ECA (SOT-23)</p>  <p>1.IN 2.GND 3.OUT</p> <p>Abbreviated symbol : 24</p>
<p>DTC114ESA (TO-92S)</p>  <p>1.GND 2.OUT 3.IN</p>	

ABSOLUTE MAXIMUM RATINGS (T_A=25°C unless otherwise noted)

Parameter	Symbol	Limits (DTC114E□)					Unit
		M	E	UA	CA	SA	
Collector-Base Voltage	V _{CC}	50					V
Input voltage	V _{IN}	-10~40					V
Output current	I _O	50					mA
	I _{C(MAX)}	100					
Power dissipation	P _D	100	150	200	300	mW	
Junction & Storage temperature	T _J , T _{STG}	150, -55~150					°C

ELECTRICAL CHARACTERISTICS ($T_A=25^\circ\text{C}$ unless otherwise noted)

Parameter	Symbol	Min.	Typ.	Max.	Unit	Test Conditions
Input voltage	$V_{I(off)}$	0.5	-	-	V	$V_{CC}=5\text{V}, I_O=100\mu\text{A}$
	$V_{I(on)}$	-	-	3		$V_O=0.3\text{V}, I_O=10\text{mA}$
Output voltage	$V_{O(on)}$	-	-	0.3	V	$I_O/I_I=10\text{mA}/0.5\text{mA}$
Input current	I_I	-	-	0.88	mA	$V_I=5\text{V}$
Output current	$I_{O(off)}$	-	-	0.5	μA	$V_{CC}=50\text{V}, V_I=0$
DC current gain	G_I	30	-	-		$V_O=5\text{V}, I_O=5\text{mA}$
Input resistance	R_1	7	10	13	K Ω	
Resistance ratio	R_2/R_1	0.8	1	1.2		
Transition frequency	f_T	-	250	-	MHz	$V_O=10\text{V}, I_O=5\text{mA}, f=100\text{MHz}$

CHARACTERISTIC CURVES

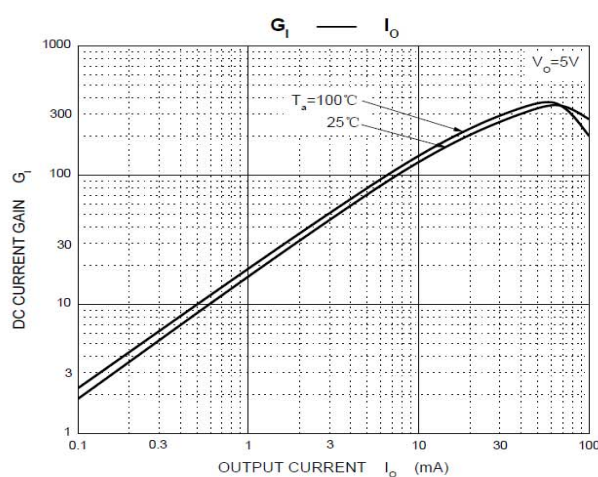
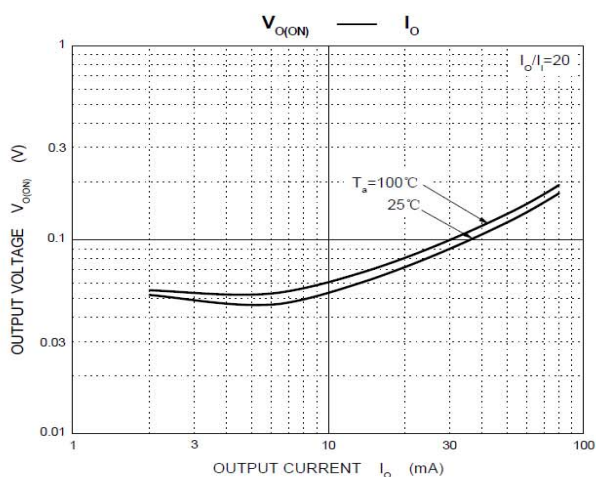
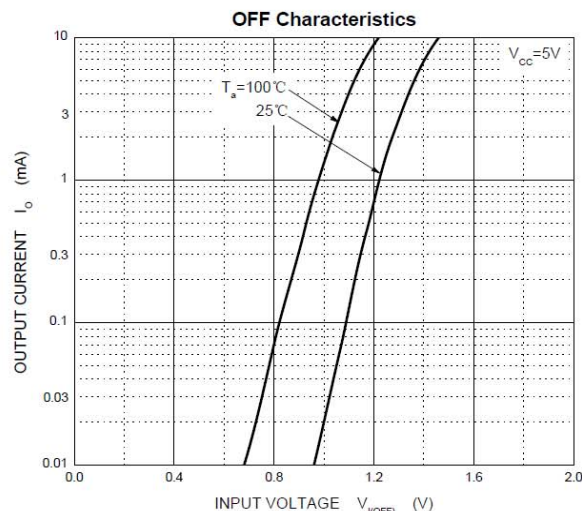
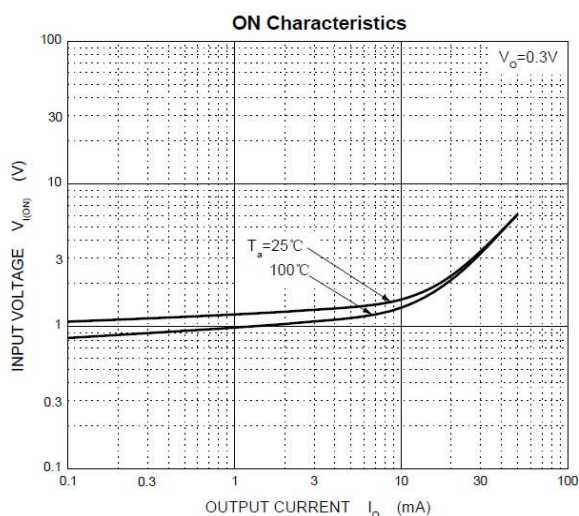

CHARACTERISTIC CURVES

