

Bias Resistor Transistor

NPN Silicon Surface Mount Transistor with Monolithic Bias Resistor Network

This new series of digital transistors is designed to replace a single device and its external resistor bias network. The BRT (Bias Resistor Transistor) contains a single transistor with a monolithic bias network resistor. The BRT eliminates these individual components by integrating them into a single device. The use of a BRT can reduce both system cost and board space. The device is housed in the SOT-23 package which is designed for low power surface mount applications.

- Simplifies Circuit Design
- Reduces Board Space and Component Count
- The SOT-23 package can be soldered using wave or reflow. The modified gull-winged leads absorb thermal stress during soldering eliminating the possibility of damage to the die.

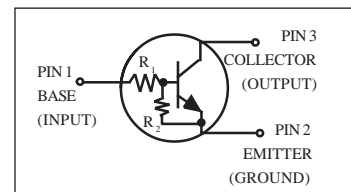
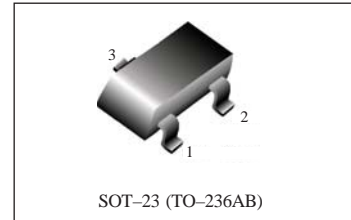

MAXIMUM RATINGS (T_A = 25 C unless otherwise noted)

Rating	Symbol	Value	Unit
Collector-Base Voltage	V _{CB0}	50	Vdc
Collector-Emitter Voltage	V _{CEO}	50	Vdc
Collector Current	I _C	100	mAdc
Total Power Dissipation @ T _A = 25 C (Note 1.) Derate above 25 C	P _D	246 1.5	mW C/W

DEVICE MARKING AND RESISTOR VALUES

Device	Marking	R1(K)	R2(K)	Shipping
DTC101	A8J	4.7	4.7	3000/Tape & Reel
DTC102	A8A	10	10	3000/Tape & Reel
DTC103	A8B	22	22	3000/Tape & Reel
DTC104	A8C	47	47	3000/Tape & Reel
DTC105	A8M	2.2	47	3000/Tape & Reel
DTC106	A8K	4.7	47	3000/Tape & Reel
DTC107	A8D	10	47	3000/Tape & Reel
DTC108	A8L	22	47	3000/Tape & Reel
DTC110	A8F	4.7	∞	3000/Tape & Reel
DTC111	A8E	10	∞	3000/Tape & Reel
DTC112	A8U	100	∞	3000/Tape & Reel
DTC114	A8T	47	∞	3000/Tape & Reel
DTC117	A8H	2.2	2.2	3000/Tape & Reel
DTC123	A8G	1.0	1.0	3000/Tape & Reel
DTC124	A8R	2.2	∞	3000/Tape & Reel

1. Device mounted on a FR-4 glass epoxy printed circuit board using the minimum recommended footprint.



THERMAL CHARACTERISTICS

Rating	Symbol	Value	Unit
Thermal Resistance – Junction-to-Ambient (Note 1.)	$R_{\theta JA}$	508	C/W
Operating and Storage Temperature Range	T_J, T_{stg}	-55 to +150	C
Maximum Temperature for Soldering Purposes, Time in Solder Bath	T_L	260 10	C Sec

ELECTRICAL CHARACTERISTICS ($T_A = 25$ C unless otherwise noted)

Characteristic	Symbol	Min	Typ	Max	Unit
OFF CHARACTERISTICS					
Collector-Base Cutoff Current ($V_{CB} = 50$ V, $I_E = 0$)	I_{CBO}	–	–	100	nAdc
Collector-Emitter Cutoff Current ($V_{CE} = 50$ V, $I_B = 0$)	I_{CEO}	–	–	500	nAdc
Emitter-Base Cutoff Current ($V_{EB} = 6.0$ V, $I_C = 0$)	I_{EBO}	–	–	1.5	mAdc
DTC101		–	–	0.5	
DTC102		–	–	0.2	
DTC103		–	–	0.1	
DTC104		–	–	0.2	
DTC105		–	–	0.18	
DTC106		–	–	0.2	
DTC107		–	–	0.13	
DTC108		–	–	1.9	
DTC110		–	–	0.9	
DTC111		–	–	0.1	
DTC112		–	–	0.2	
DTC114		–	–	2.3	
DTC117		–	–	4.3	
DTC123		–	–	4.0	
DTC124		–	–		
Collector-Base Breakdown Voltage ($I_C = 10\mu A$, $I_E = 0$)	$V_{(BR)CBO}$	50	–	–	Vdc
Collector-Emitter Breakdown Voltage (Note 2.), ($I_C = 2.0$ mA, $I_B = 0$)	$V_{(BR)CEO}$	50	–	–	Vdc
ON CHARACTERISTICS					
DC Current Gain ($V_{CE} = 10$ V, $I_C = 5.0$ mA)	h_{FE}	15	30	–	
DTC101		35	60	–	
DTC102		60	100	–	
DTC103		80	140	–	
DTC104		80	140	–	
DTC105		80	200	–	
DTC106		80	140	–	
DTC107		80	150	–	
DTC108		160	350	–	
DTC110		160	350	–	
DTC111		160	350	–	
DTC112		160	350	–	
DTC114		8.0	15	–	
DTC117		3.0	5.0	–	
DTC123		160	350	–	
DTC124					
Collector-Emitter Saturation Voltage ($I_C = 10$ mA, $I_B = 0.3$ mA) ($I_C = 10$ mA, $I_B = 5$ mA) DTC117 / DTC123 ($I_C = 10$ mA, $I_B = 1$ mA) DTC101 / DTC105 / DTC106 / DTC108 / DTC111 / DTC114 / DTC110 / DTC124	$V_{CE(sat)}$	–	–	0.25	Vdc

2. Pulse Test: Pulse Width < 300 μ s, Duty Cycle < 2.0%.



ELECTRICAL CHARACTERISTICS (T_A = 25 C unless otherwise noted)

Characteristic	Symbol	Min	Typ	Max	Unit	
ON CHARACTERISTICS (Note 3.)						
Output Voltage (on) (V _{CC} = 5.0 V, V _B = 2.5V, R _L = 1.0KΩ)	DTC101 DTC102 DTC103 DTC105 DTC106 DTC107 DTC108 DTC110 DTC111 DTC117 DTC123 DTC124 (V _{CC} = 5.0 V, V _B = 3.5V, R _L = 1.0KΩ) DTC104 DTC114 (V _{CC} = 5.0 V, V _B = 5.0V, R _L = 1.0KΩ) DTC112	V _{OL}	–	–	0.2	Vdc
Output Voltage (off) (V _{CC} = 5.0 V, V _B = 0.5V, R _L = 1.0KΩ) (V _{CC} = 5.0 V, V _B = 0.05V, R _L = 1.0KΩ) (V _{CC} = 5.0 V, V _B = 0.25V, R _L = 1.0KΩ)	DTC123 DTC111 DTC106 DTC110 DTC124	V _{OH}	4.9	–	–	Vdc
Input Resistor	DTC101 DTC102 DTC103 DTC104 DTC105 DTC106 DTC107 DTC108 DTC110 DTC111 DTC112 DTC114 DTC117 DTC123 DTC124	R _I	3.3 7.0 15.4 32.9 1.54 3.3 7.0 15.4 3.3 7.0 70 32.9 1.5 0.7 1.54	4.7 10 22 47 2.2 4.7 10 22 4.7 10 100 47 2.2 1.0 2.2	6.1 13 28.6 61.1 2.86 6.1 13 28.6 6.1 13 130 61.1 2.9 1.3 2.88	KΩ
Resistor Ratio	DTC101 / DTC123 / DTC117 DTC102 / DTC103 / DTC104 DTC105 DTC106 DTC107 DTC108 DTC110 / DTC111 / DTC124 DTC112 / DTC114	R ₁ /R ₂	0.8 0.8 0.038 0.055 0.17 0.38 – –	1.0 1.0 0.047 0.1 0.21 0.47 – –	1.2 1.2 0.056 0.185 0.25 0.56 – –	

3. Pulse Test: Pulse Width < 300μs, Duty Cycle < 2.0%.

TYPICAL ELECTRICAL CHARACTERISTICS
DTC101

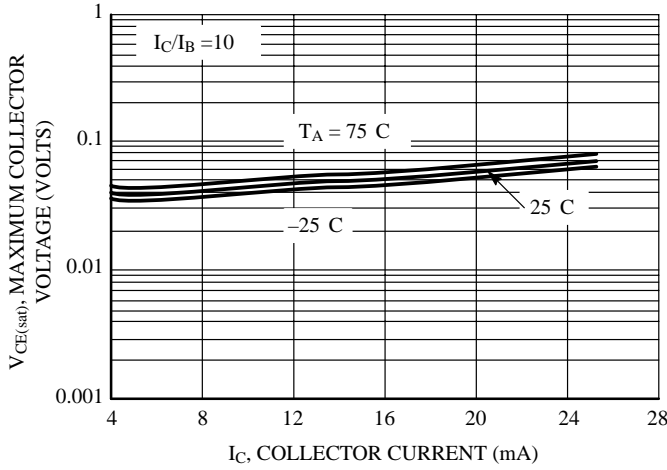

Figure 22. $V_{CE(sat)}$ vs. I_C

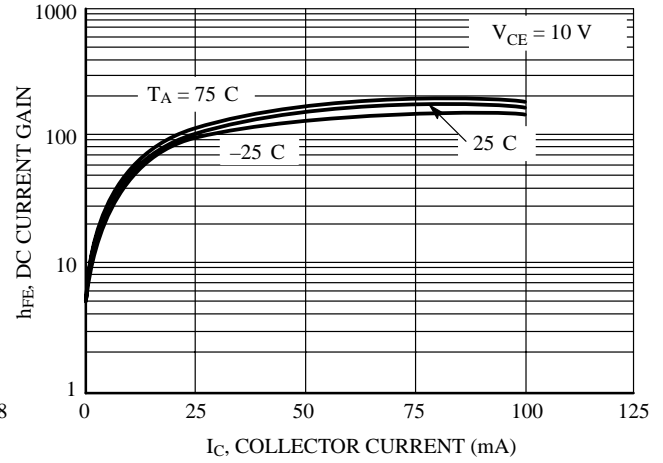

Figure 23. DC Current Gain

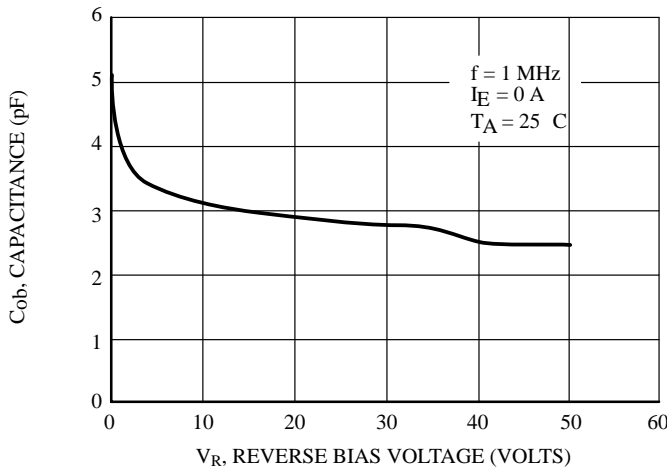

Figure 24. Output Capacitance

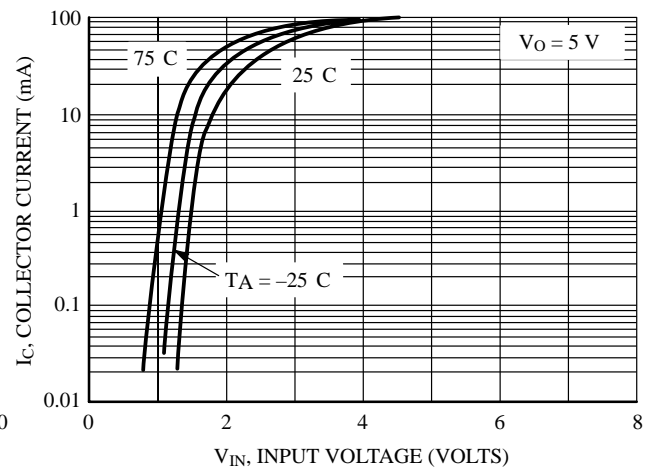

Figure 25. Output Current vs. Input Voltage

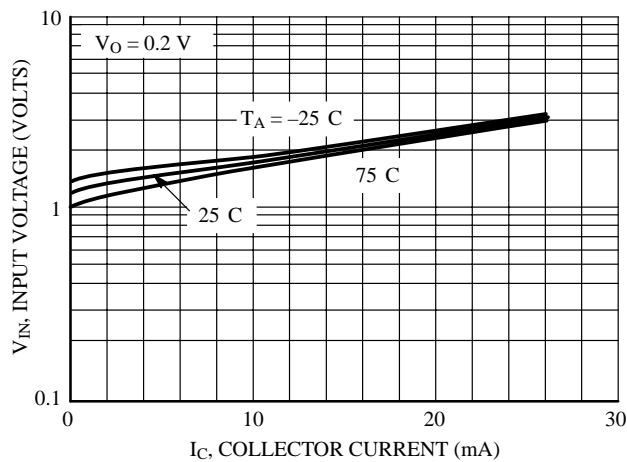

Figure 26. Output Voltage vs. Input Current

TYPICAL ELECTRICAL CHARACTERISTICS
DTC102

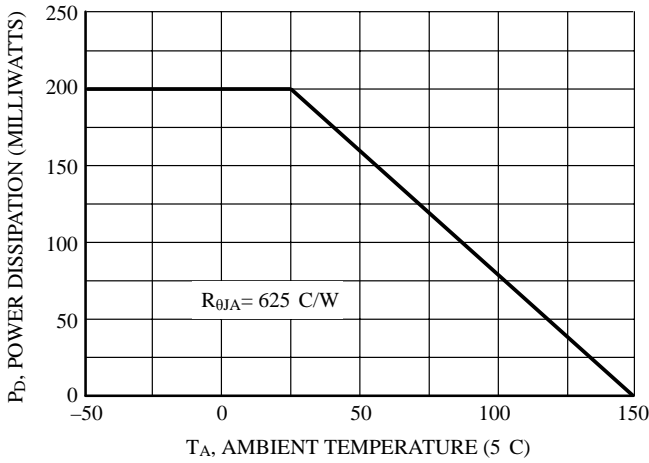

Figure 1. Derating Curve

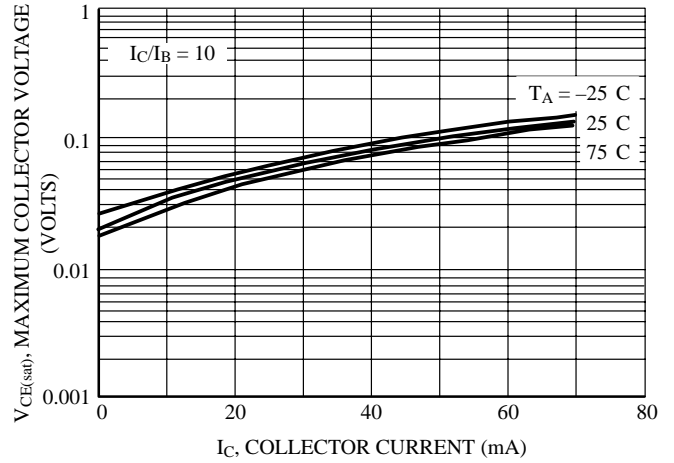

Figure 2. $V_{CE(sat)}$ vs. I_C

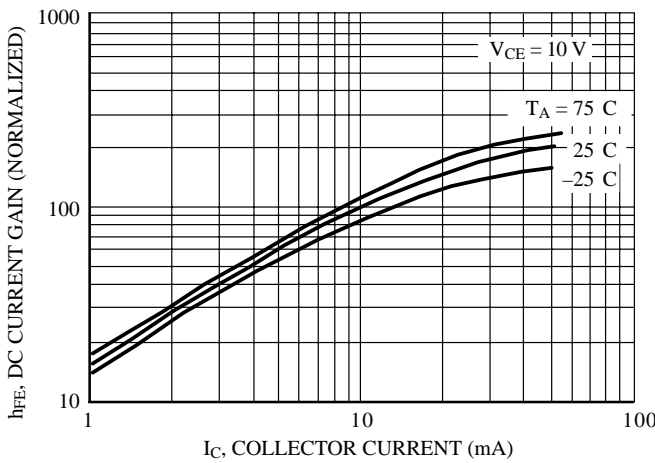

Figure 3. DC Current Gain

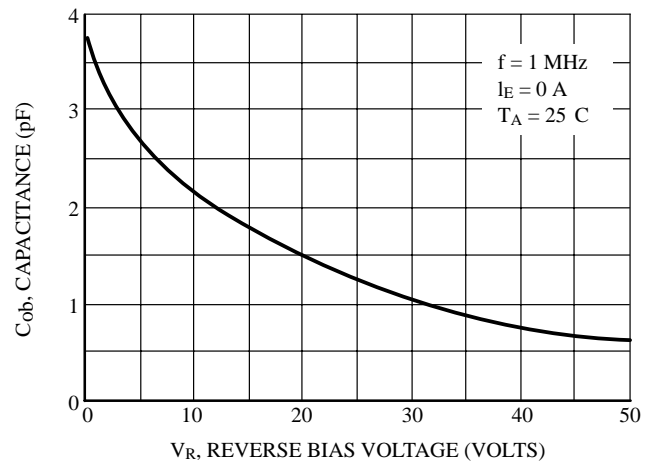

Figure 4. Output Capacitance

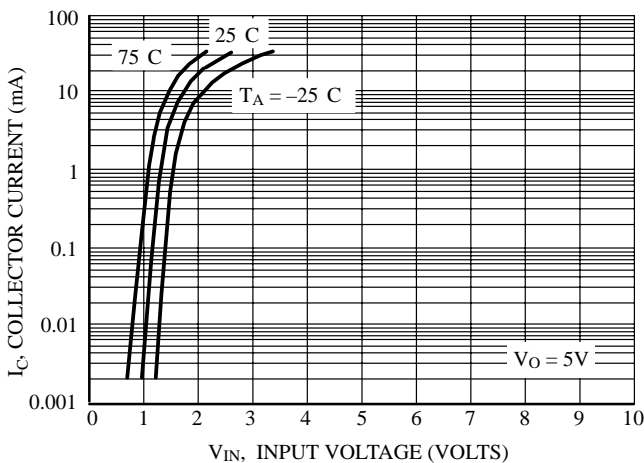

Figure 5. Output Current vs. Input Voltage

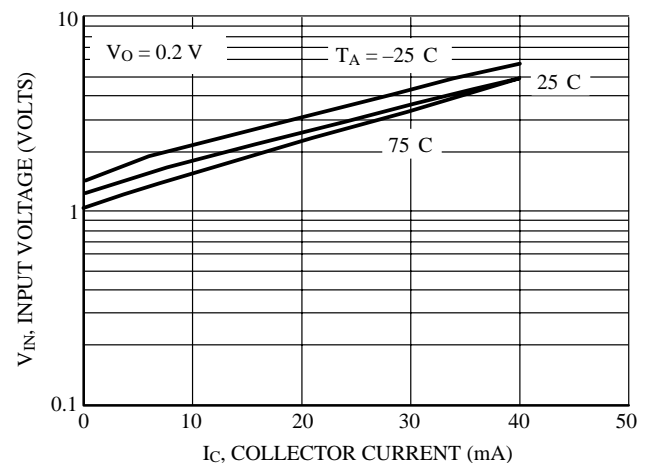

Figure 6. Input Voltage vs. Output Current

TYPICAL ELECTRICAL CHARACTERISTICS
DTC103

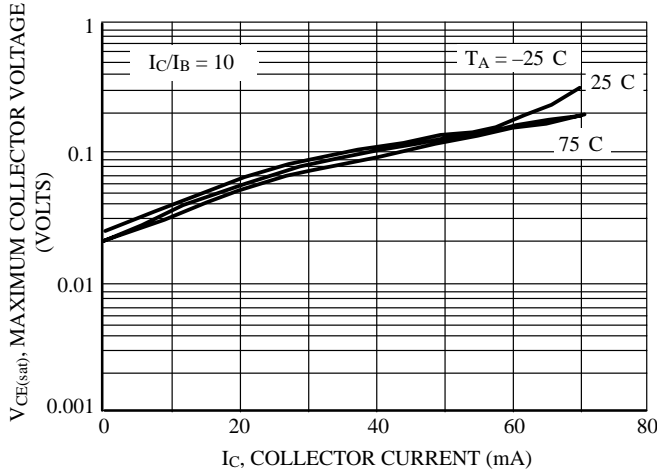

Figure 7. $V_{CE(sat)}$ vs. I_C

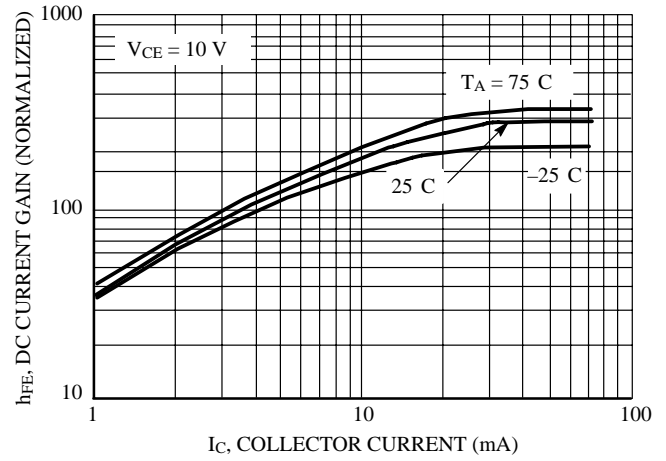

Figure 8. DC Current Gain

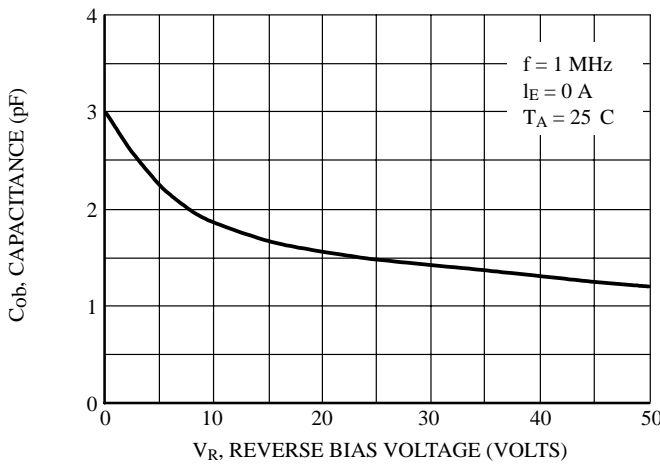

Figure 9. Output Capacitance

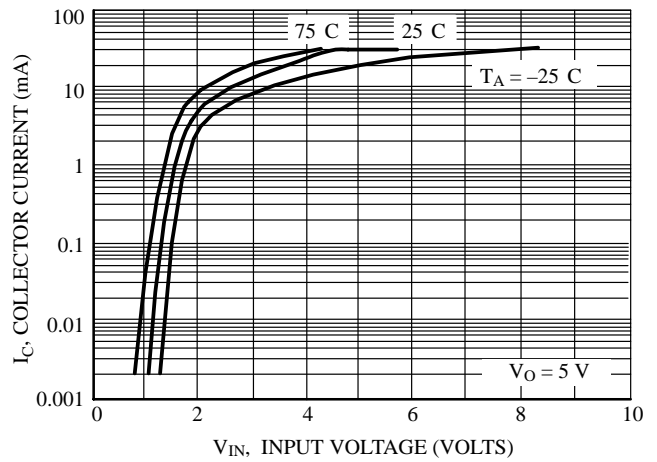

Figure 10. Output Current vs. Input Voltage

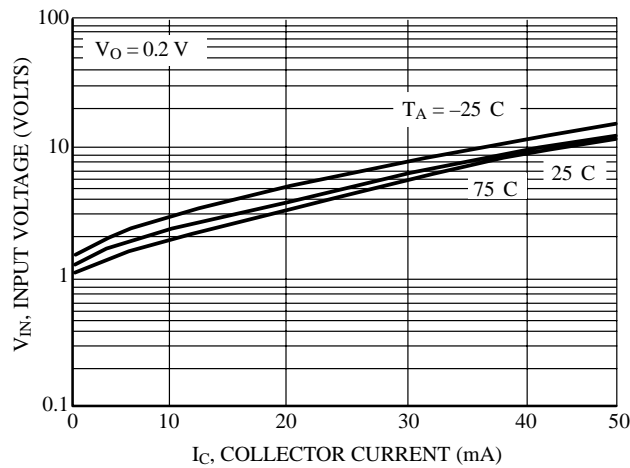

Figure 11. Input Voltage vs. Output Current

TYPICAL ELECTRICAL CHARACTERISTICS
DTC104

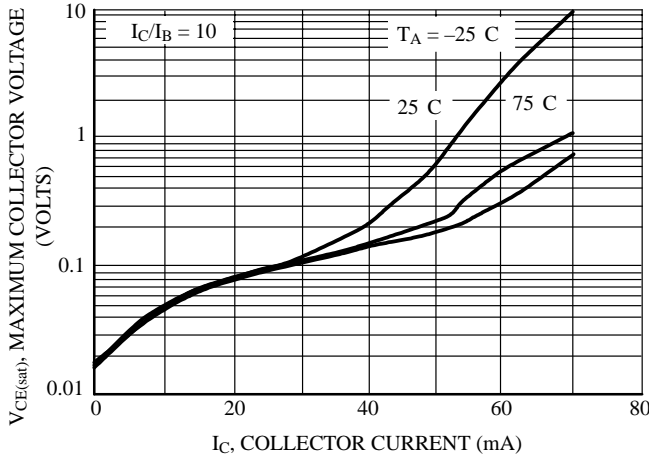

Figure 12. $V_{CE(sat)}$ vs. I_C

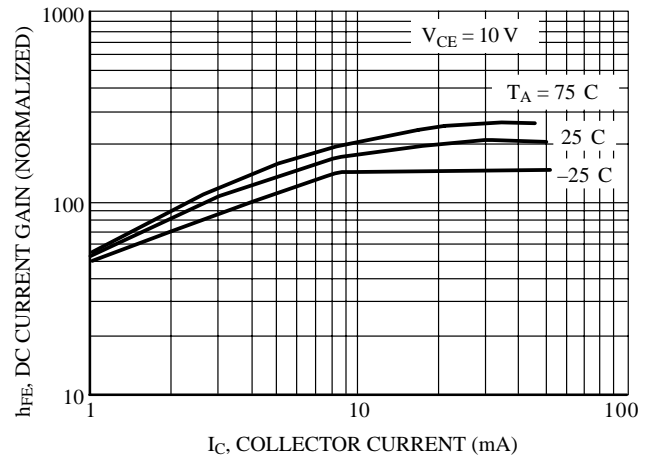

Figure 13. DC Current Gain

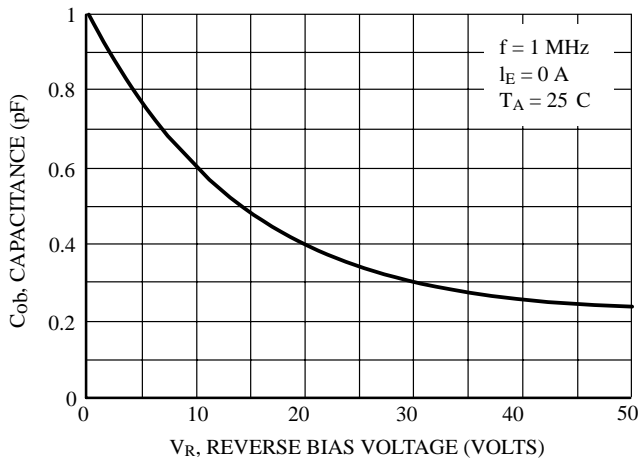

Figure 14. Output Capacitance

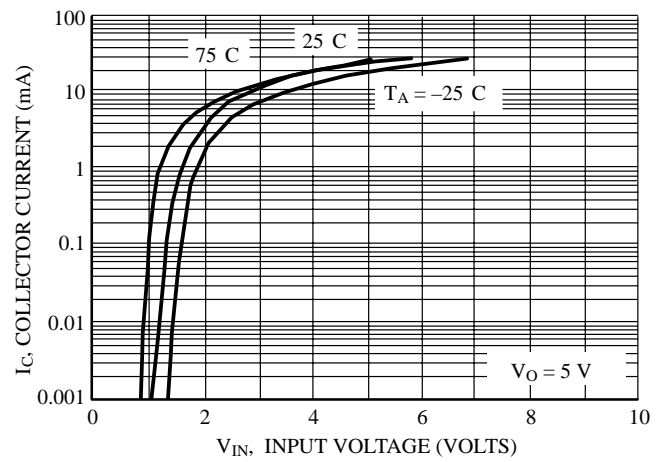

Figure 15. Output Current vs. Input Voltage

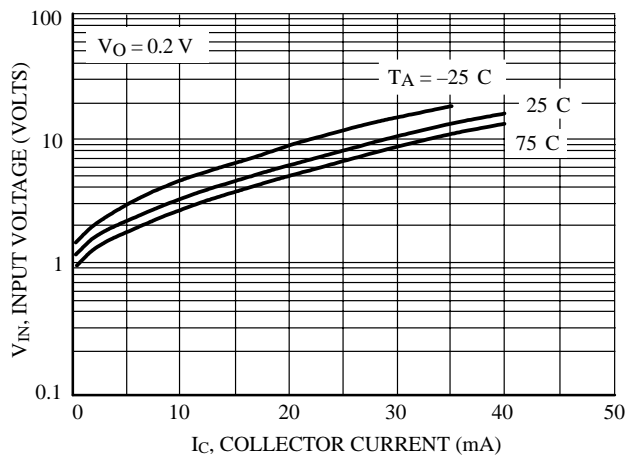

Figure 16. Input Voltage vs. Output Current

TYPICAL ELECTRICAL CHARACTERISTICS
DTC106

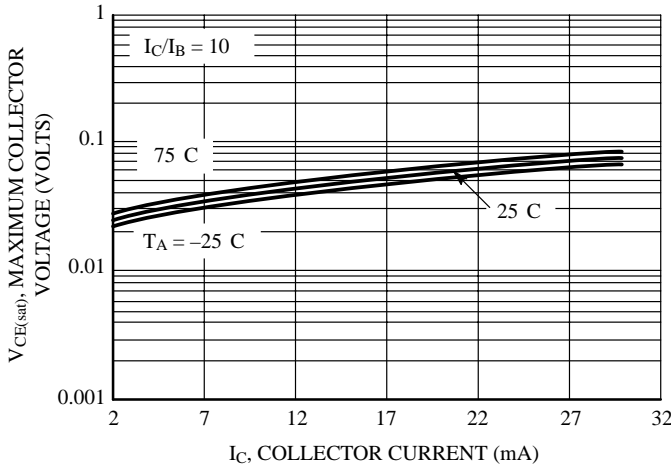

Figure 27. $V_{CE(sat)}$ vs. I_C

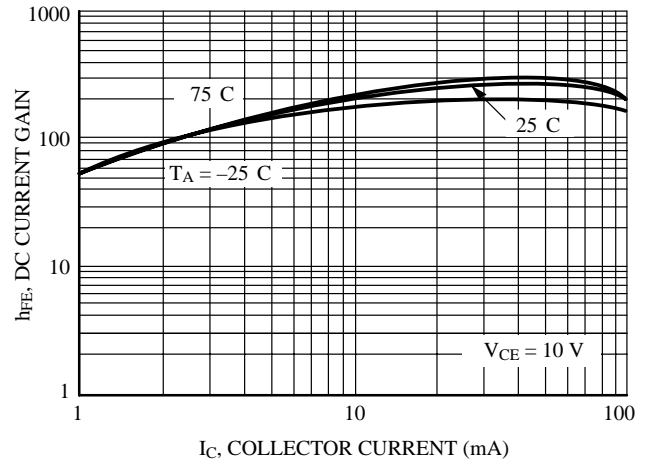

Figure 28. DC Current Gain

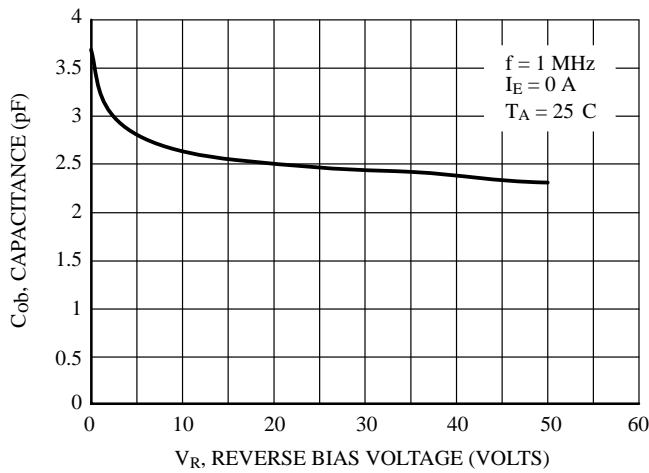

Figure 29. Output Capacitance

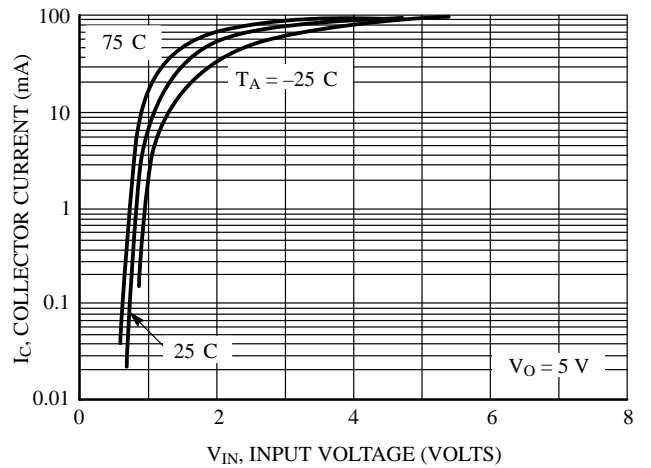

Figure 30. Output Current vs. Input Voltage

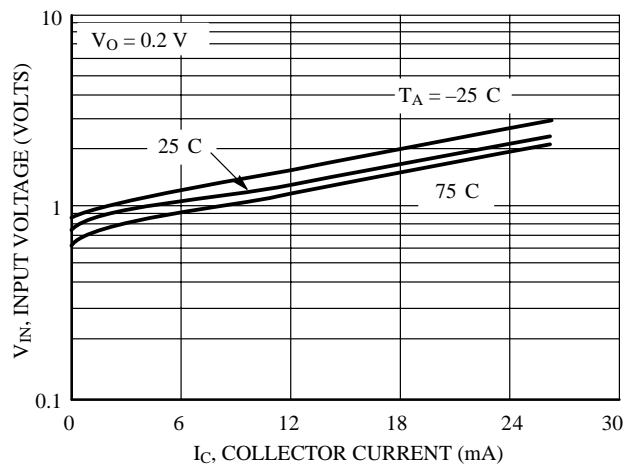

Figure 31. Input Voltage vs. Output Current

TYPICAL ELECTRICAL CHARACTERISTICS
DTC107

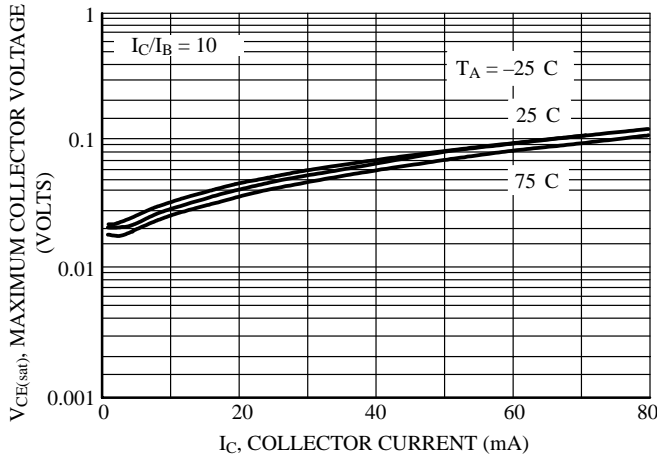

Figure 17. $V_{CE(sat)}$ vs. I_C

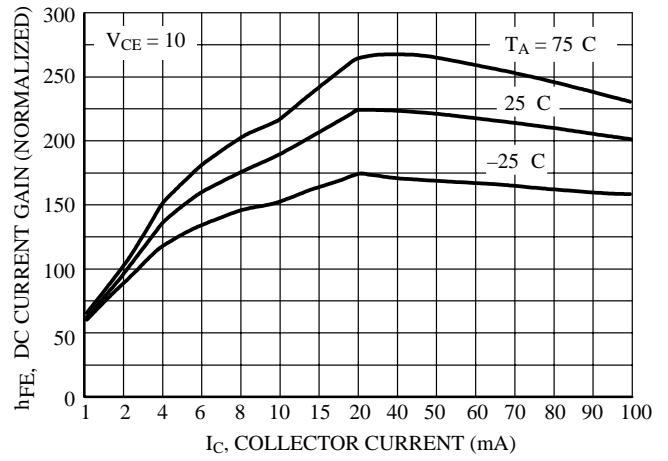

Figure 18. DC Current Gain

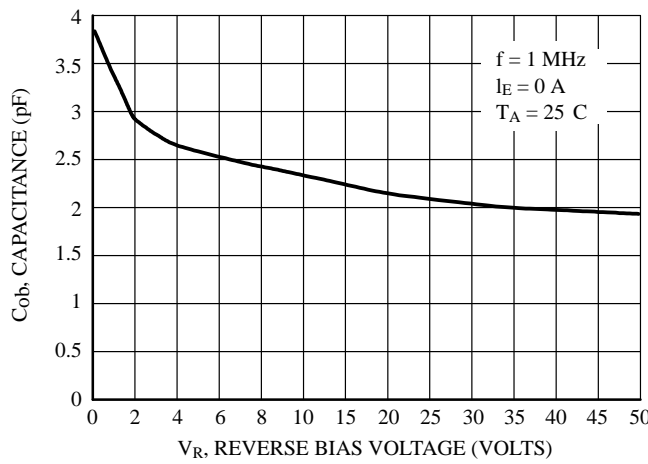

Figure 19. Output Capacitance

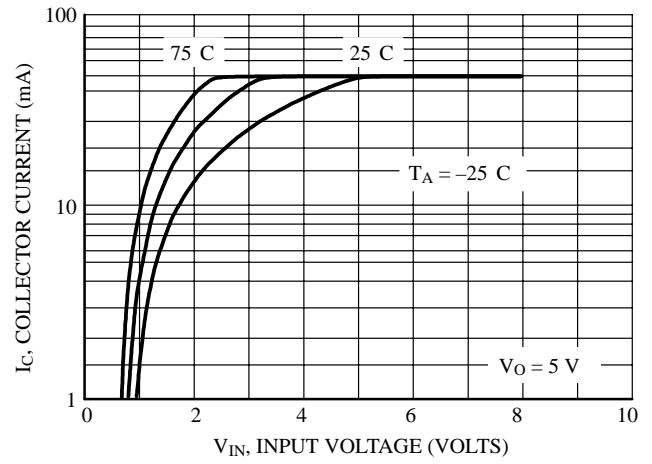

Figure 20. Output Current vs. Input Voltage

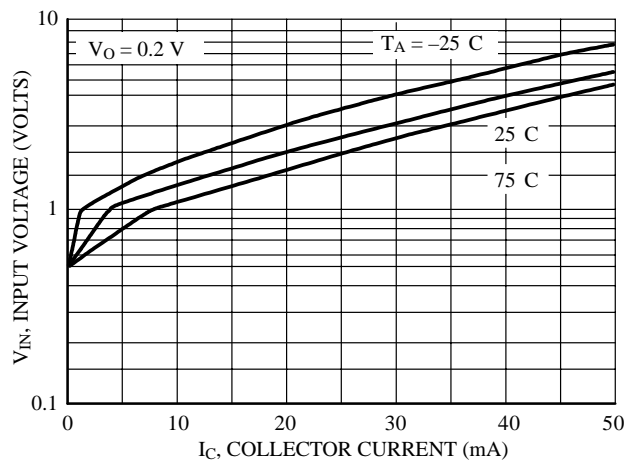

Figure 21. Input Voltage vs. Output Current



TYPICAL ELECTRICAL CHARACTERISTICS
DTC110

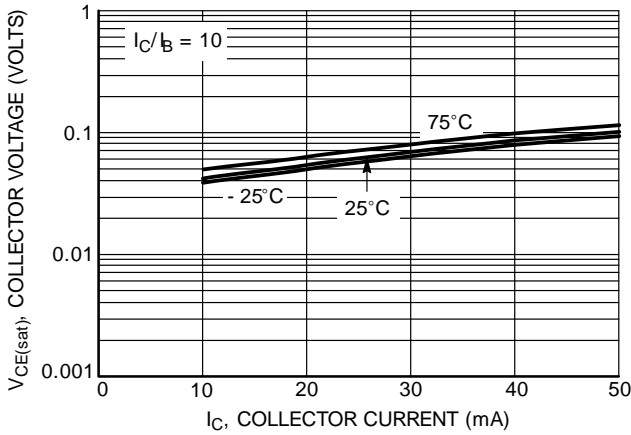

Figure 27. $V_{CE(sat)}$ versus I_C

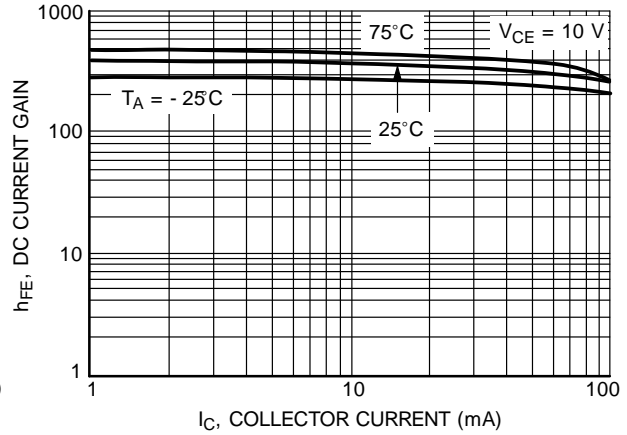

Figure 28. DC Current Gain

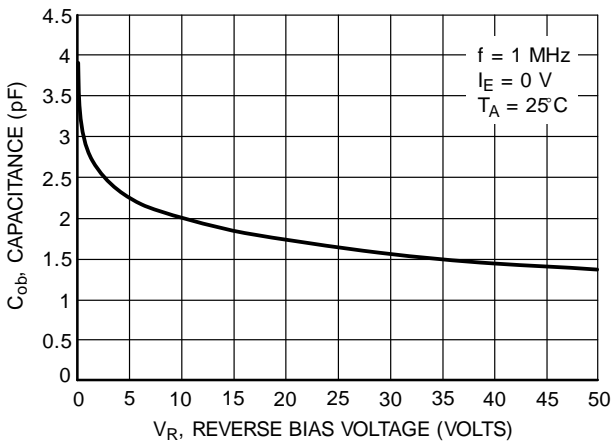

Figure 29. Output Capacitance

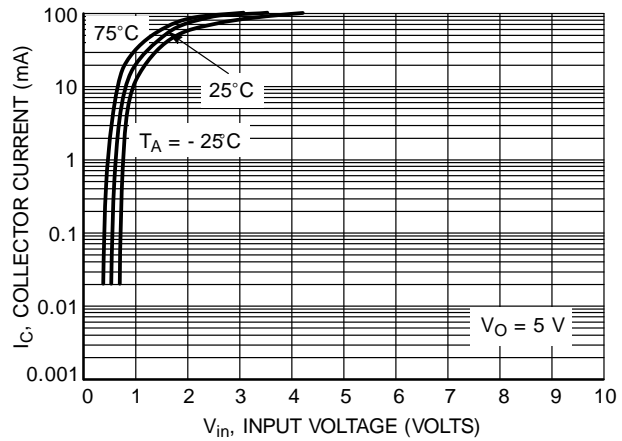

Figure 30. Output Current versus Input Voltage

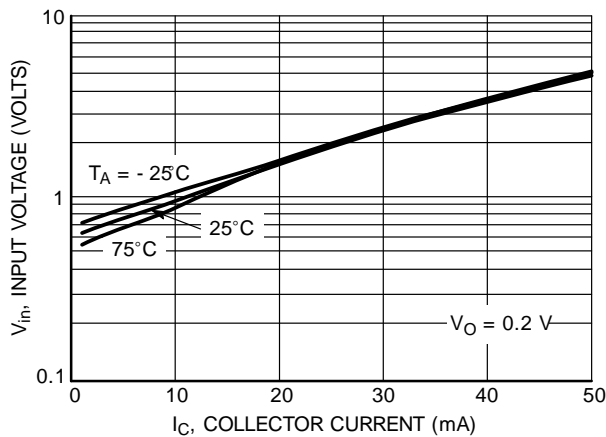

Figure 31. Input Voltage versus Output Current

TYPICAL ELECTRICAL CHARACTERISTICS
DTC111

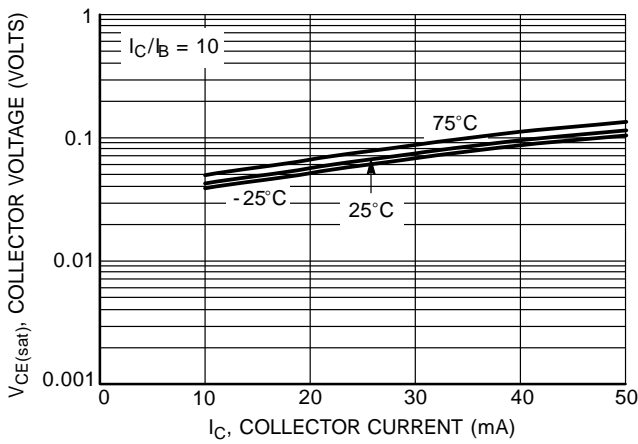

Figure 22. $V_{CE(sat)}$ versus I_C

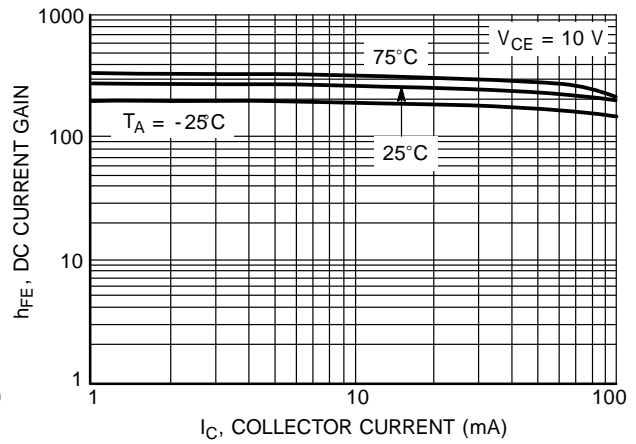

Figure 23. DC Current Gain

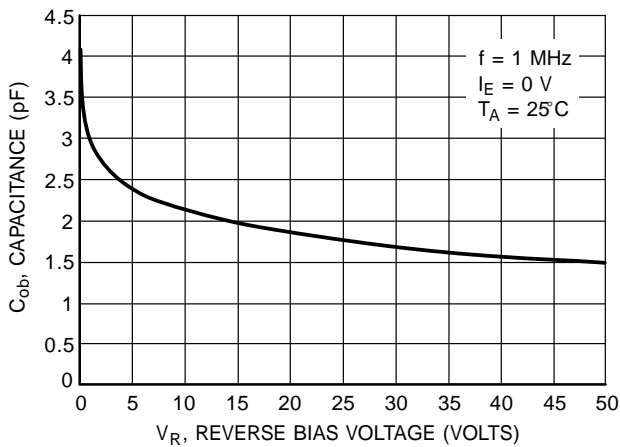

Figure 24. Output Capacitance

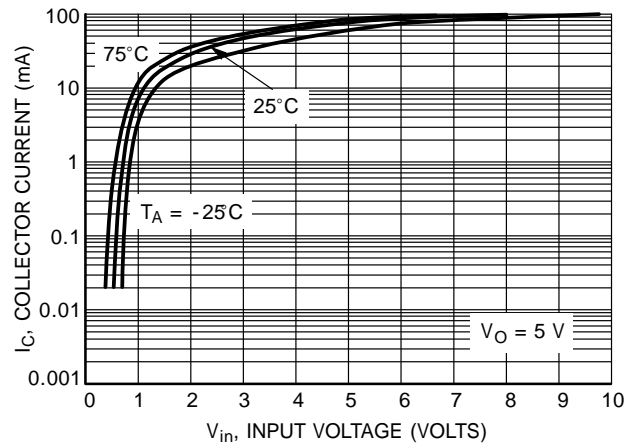

Figure 25. Output Current versus Input Voltage

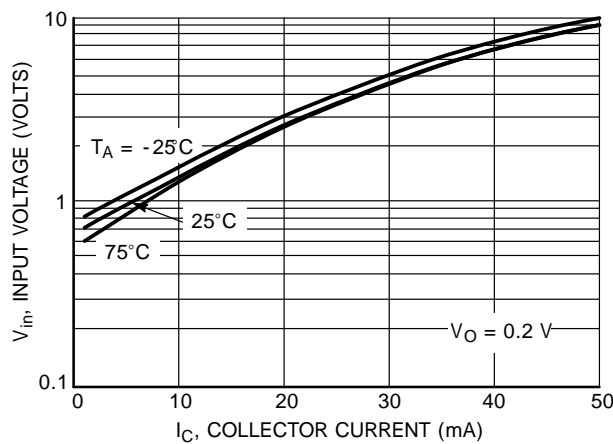

Figure 26. Input Voltage versus Output Current

TYPICAL ELECTRICAL CHARACTERISTICS
DTC117

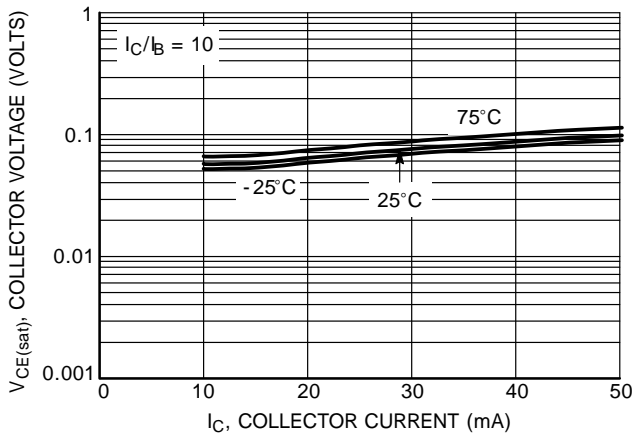

Figure 37. $V_{CE(sat)}$ versus I_C

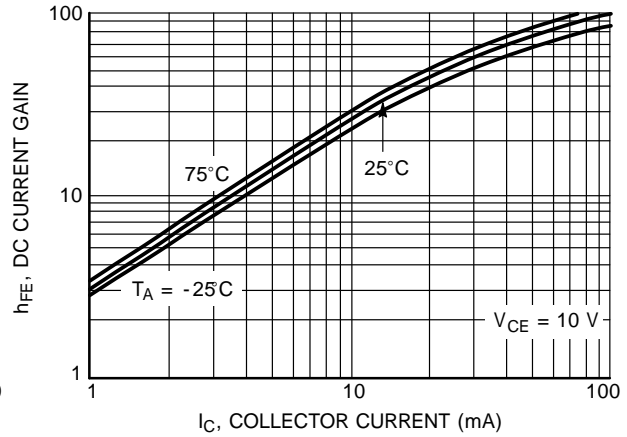

Figure 38. DC Current Gain

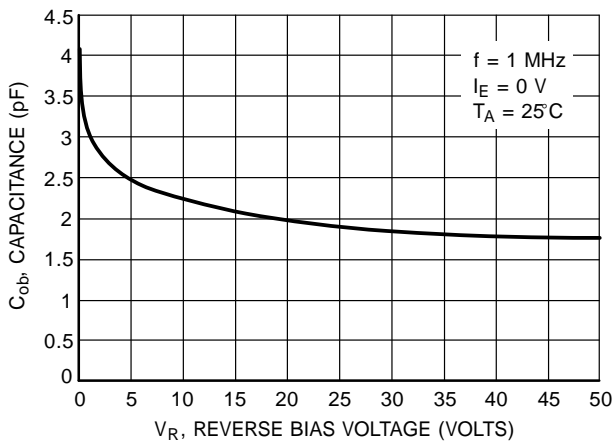

Figure 39. Output Capacitance

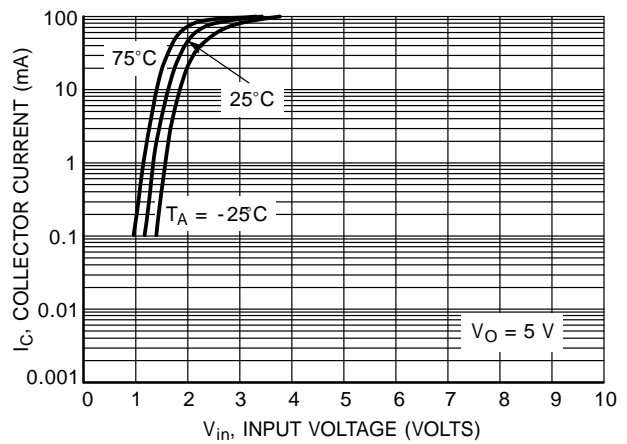

Figure 40. Output Current versus Input Voltage

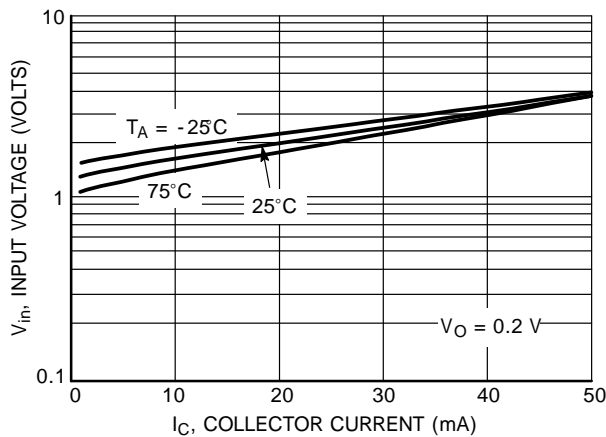

Figure 41. Input Voltage versus Output Current

TYPICAL ELECTRICAL CHARACTERISTICS
DTC108

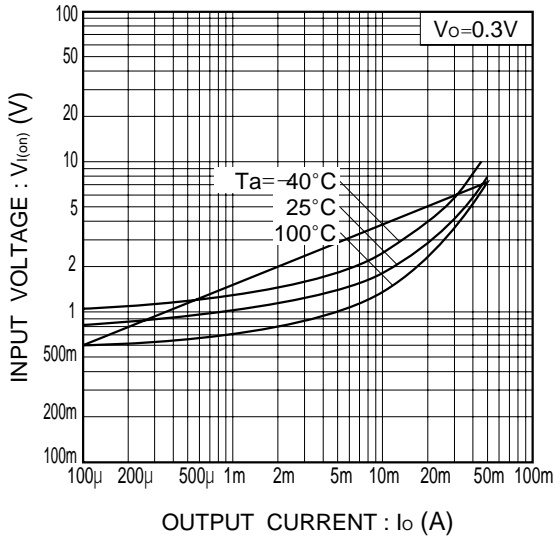

Fig.1 Input voltage vs. output current (ON characteristics)

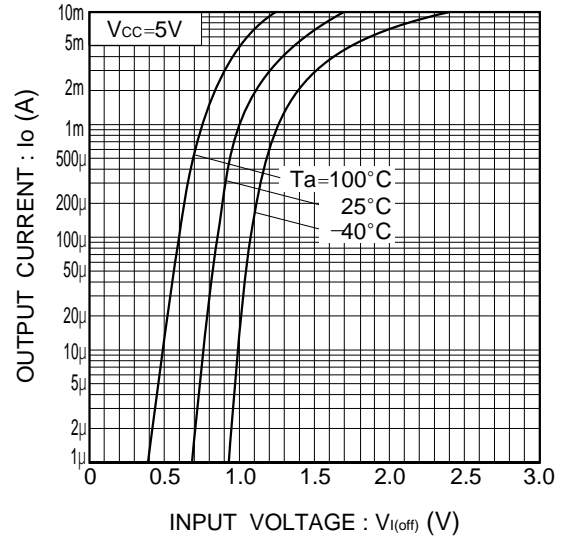

Fig.2 Output current vs. input voltage (OFF characteristics)

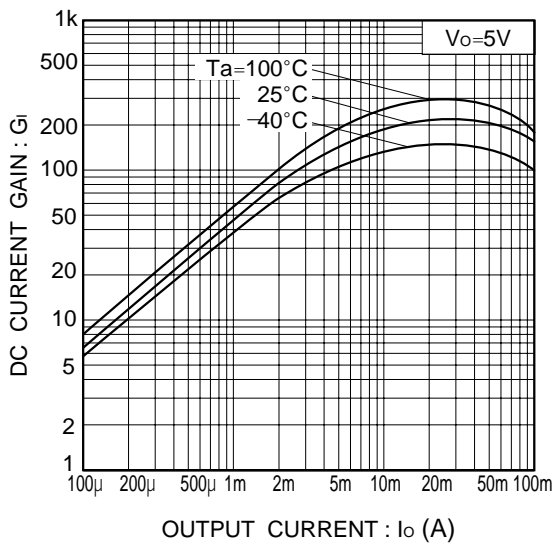

Fig.3 DC current gain vs. output current

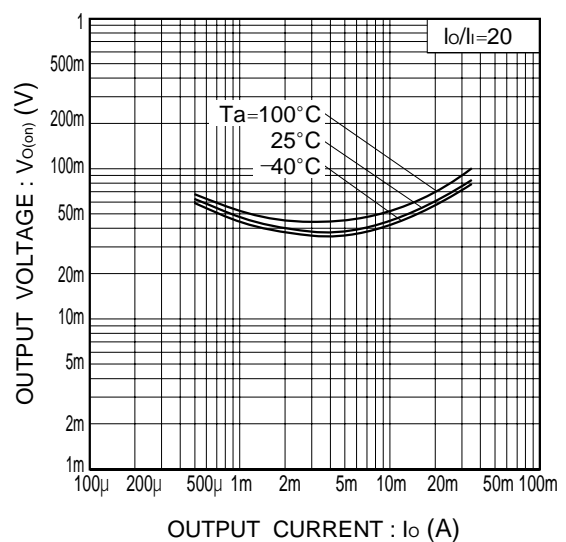

Fig.4 Output voltage vs. output current

TYPICAL ELECTRICAL CHARACTERISTICS
DTC123

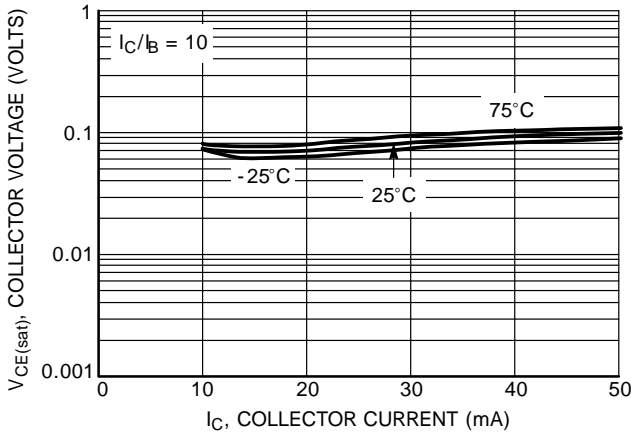

Figure 32. $V_{CE(sat)}$ versus I_C

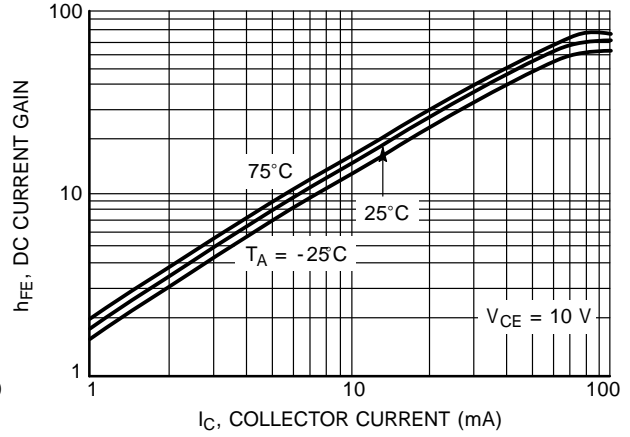

Figure 33. DC Current Gain

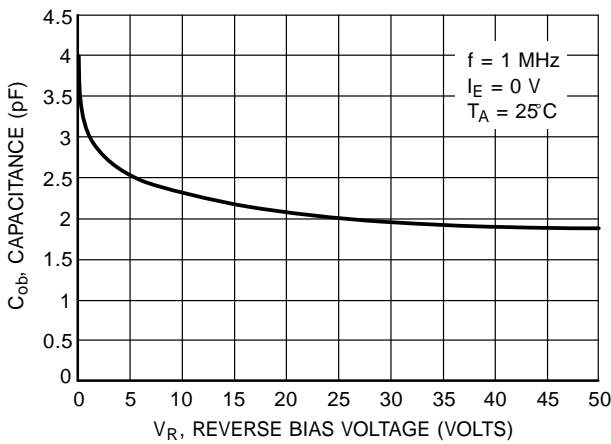

Figure 34. Output Capacitance

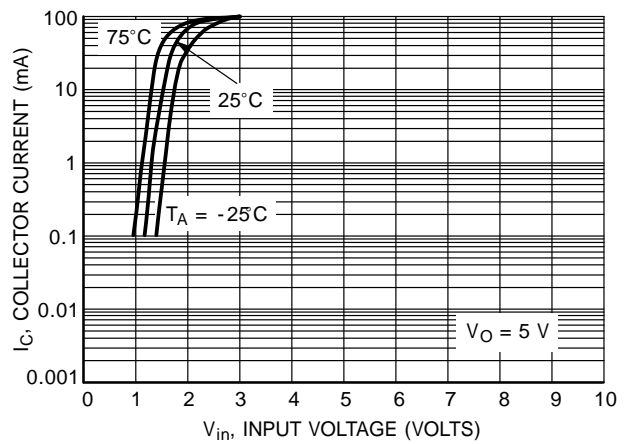

Figure 35. Output Current versus Input Voltage

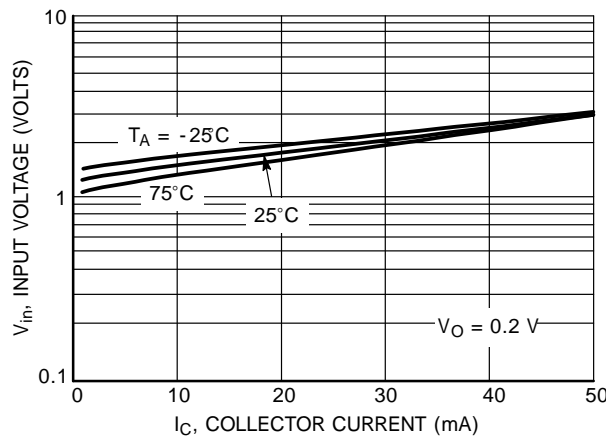

Figure 36. Input Voltage versus Output Current

TYPICAL APPLICATIONS FOR NPN BRTs

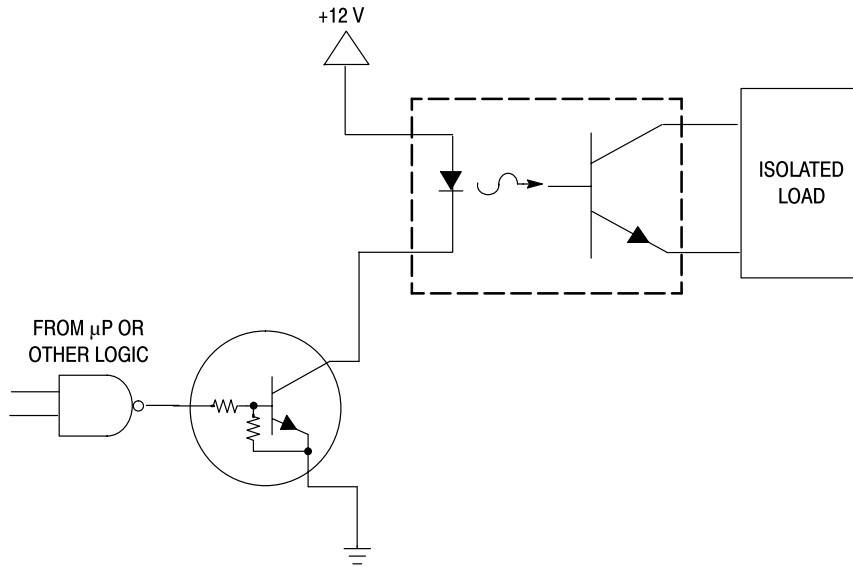

Figure 32. Level Shifter: Connects 12 or 24 Volt Circuits to Logic

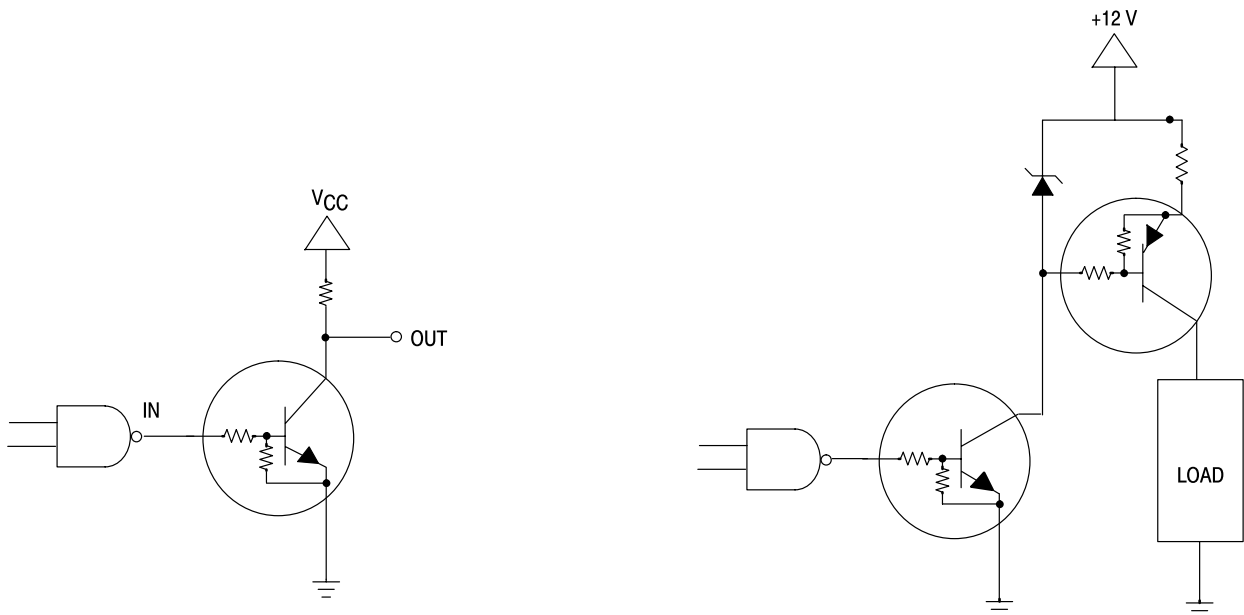
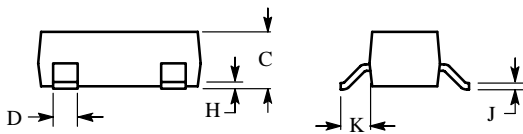
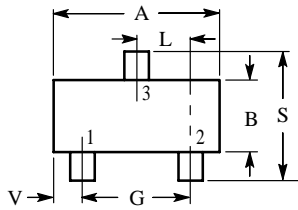

Figure 33. Open Collector Inverter: Inverts the Input Signal

Figure 34. Inexpensive, Unregulated Current Source

SOT-23



NOTES:

1. DIMENSIONING AND TOLERANCING PER ANSI Y14.5M, 1982.
2. CONTROLLING DIMENSION: INCH.

DIM	INCHES		MILLIMETERS	
	MIN	MAX	MIN	MAX
A	0.1102	0.1197	2.80	3.04
B	0.0472	0.0551	1.20	1.40
C	0.0350	0.0440	0.89	1.11
D	0.0150	0.0200	0.37	0.50
G	0.0701	0.0807	1.78	2.04
H	0.0005	0.0040	0.013	0.100
J	0.0034	0.0070	0.085	0.177
K	0.0140	0.0285	0.35	0.69
L	0.0350	0.0401	0.89	1.02
S	0.0830	0.1039	2.10	2.64
V	0.0177	0.0236	0.45	0.60

