

Small Signal Product

NPN Small Signal Transistor

FEATURES

- Built-in bias resistors enable the configuration of an inverter circuit without connecting external input resistor (see equivalent circuit).
- The bias resistors consist of thin-film resistors with complete isolation to allow negative biasing of the input. They also have the advantage of almost completely eliminating parasitic effects.
- Only the on/off conditions need to be set for operation, marking device design easy.
- Packing code with suffix "G" means green compound (halogen-free)

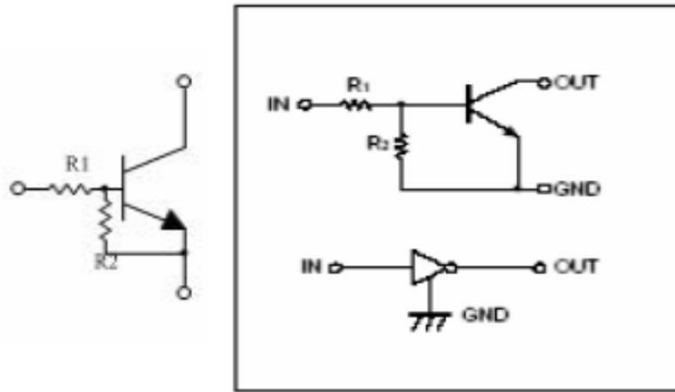

Equivalent Circuit

MAXIMUM RATINGS AND ELECTRICAL CHARACTERISTICS (T _A =25°C unless otherwise noted)					
PARAMETER	SYMBOL	VALUE			UNIT
		YE	YUA / YCA	YSA	
Power Dissipation	P _D	150	200	300	mW
Supply Voltage	V _{CC}	50			V
Input Voltage	V _{IN}	-5 ~ +12			V
Output Current	I _O	100			mA
	I _{C(MAX)}	100			
Junction and Storage Temperature Range	T _J , T _{STG}	-55 to +150			°C

Note 1: Valid provided that electrodes are kept at ambient temperature

PARAMETER	SYMBOL	MIN	TYP	MAX	CONDITION	UNIT
Input Voltage	V _{I(off)}	0.3	-	-	V _{CC} =5V, I _O =100μA	V
	V _{I(on)}	-	-	3	V _O =0.3V, I _O =20mA	
Output Voltage	V _{O(on)}	-	0.1	0.3	I _O /I _I =10mA/0.5mA	V
Input Current	I _I	-	-	3.8	V _I =5V	mA
Output Current	I _{O (off)}	-	-	0.5	V _{CC} =50V, V _I =0	μA
DC Current Gain	G _I	33	-	-	V _O =5V, I _O =10mA	
Input Resistance	R ₁	1.54	2.2	2.86		KΩ
Resistance Ratio	R ₂ /R ₁	3.6	4.5	5.5		
Transition Frequency	f _T	-	250	-	V _O =10V, I _O =5mA, f=100MHz	MHz

Small Signal Product

ORDERING INFORMATION					
PART NO.	PART NO. SUFFIX (Note 1)	PACKING CODE	PACKING CODE SUFFIX	PACKAGE	PACKING
DTC123YE	-xx	RS	G	SOT-523	3K / 7" Reel
DTC123YUA		RV		SOT-323	3K / 7" Reel
DTC123YCA		RU		SOT-23	3K / 7" Reel
DTC123YSA		A3		TO-92S	3K / Box (Ammo)
		B3			10K / Box (Bulk)

Note 1: Part No. Suffix „-xx “ would be used for special requirement

EXAMPLE					
PREFERRED PART NO.	PART NO.	PART NO. SUFFIX	PACKING CODE	PACKING CODE SUFFIX	DESCRIPTION
DTC123YE RS	DTC123YE		RS		Multiple manufacture source
DTC123YE RSG	DTC123YE		RS	G	Multiple manufacture source Green compound
DTC123YE-M0 RSG	DTC123YE	M0	RS	G	Defined manufacture source Green compound

PIN CONNENCTIONS AND MARKING

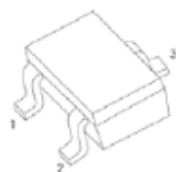
DTC123YE

SOT-523

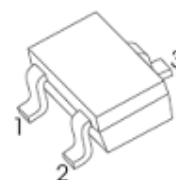
- 1. IN
- 2. GND
- 3. OUT

MARKING: 62
DTC123YUA

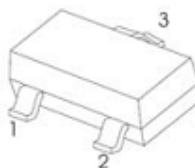
SOT-323

- 1. IN
- 2. GND
- 3. OUT

MARKING: 62
DTC123YCA

SOT-23

- 1. IN
- 2. GND
- 3. OUT

MARKING: 62
DTC123YSA
MARKING:
C123
Y041
MARKING(HF):
C123
Y-041

TO-92S

- 1. GND
- 2. OUT
- 3. IN

Small Signal Product

PACKAGE OUTLINE DIMENSION

SOT-23

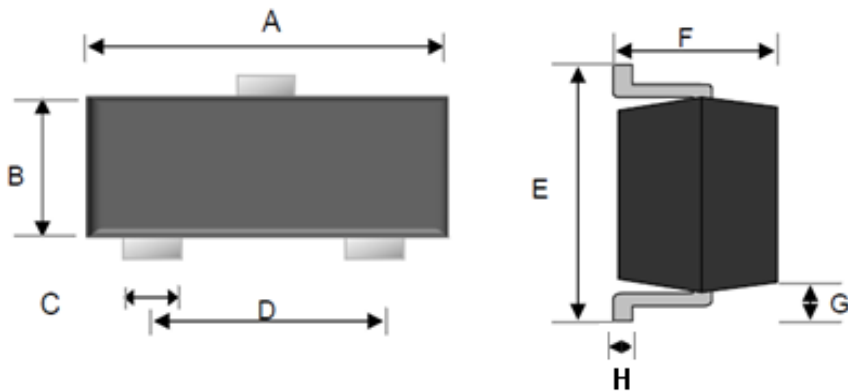

DIM.	Unit (mm)		Unit (inch)	
	Min	Max	Min	Max
A	2.70	3.10	0.106	0.122
B	1.10	1.50	0.043	0.059
C	0.30	0.51	0.012	0.020
D	1.78	2.04	0.070	0.080
E	2.10	2.64	0.083	0.104
F	0.89	1.30	0.035	0.051
G	0.55 REF		0.022 REF	
H	0.10 REF		0.004 REF	

SOT-323

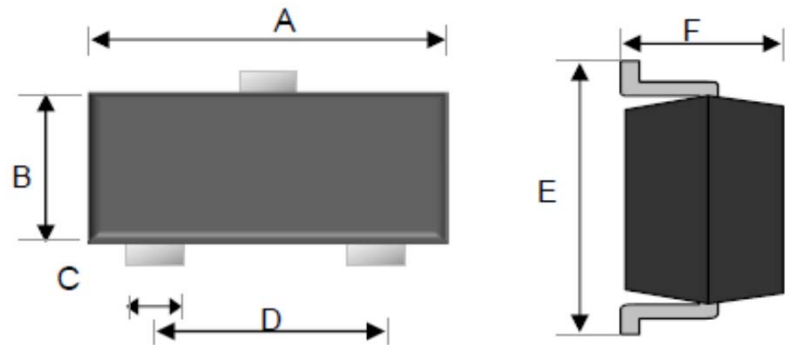

DIM.	Unit (mm)		Unit (inch)	
	Min	Max	Min	Max
A	1.80	2.20	0.071	0.087
B	1.15	1.35	0.045	0.053
C	0.15	0.40	0.006	0.016
D	1.20	1.40	0.047	0.055
E	2.00	2.45	0.079	0.096
F	0.80	1.10	0.031	0.043

SOT-523

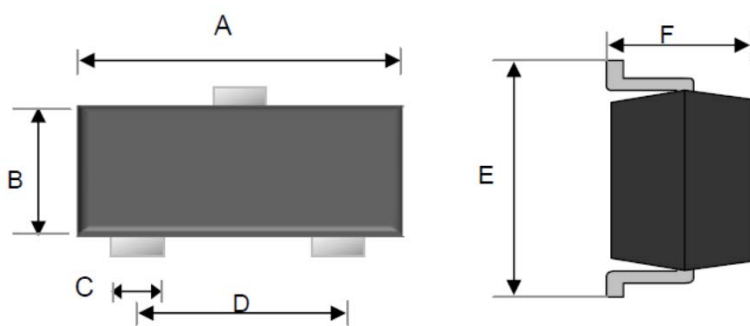

DIM.	Unit (mm)		Unit (inch)	
	Min	Max	Min	Max
A	1.50	1.70	0.059	0.067
B	0.70	0.90	0.028	0.035
C	0.15	0.35	0.006	0.014
D	0.90	1.10	0.035	0.043
E	1.45	1.75	0.057	0.069
F	0.62	0.95	0.024	0.037

Small Signal Product

TO-92S (Ammo)

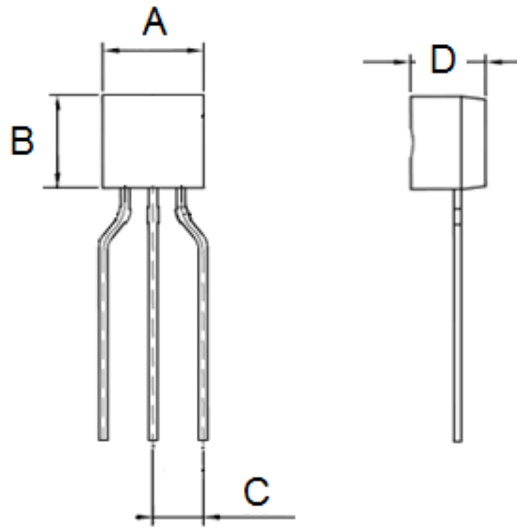

DIM.	Unit (mm)		Unit (inch)	
	Min	Max	Min	Max
A	3.90	4.10	0.154	0.161
B	3.25	3.05	0.128	0.120
C	2.20	2.80	0.087	0.110
D	1.62	1.42	0.064	0.056

TO-92S (Bulk)

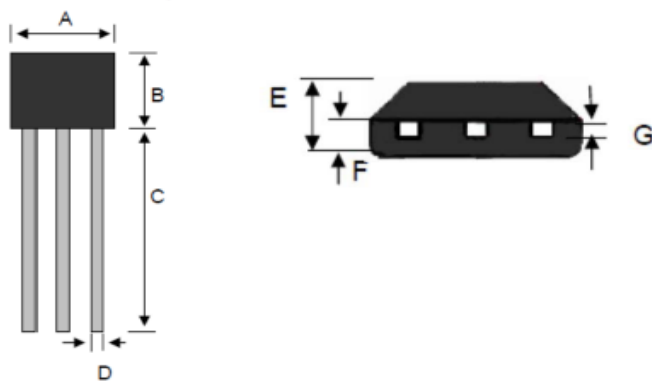

DIM.	Unit (mm)		Unit (inch)	
	Min	Max	Min	Max
A	3.90	4.10	0.154	0.161
B	3.05	3.25	0.120	0.128
C	15.10	15.50	0.594	0.610
D	0.35	0.48	0.014	0.019
E	1.42	1.62	0.056	0.064
F	0.66	0.86	0.026	0.034
G	0.36	0.51	0.014	0.020

Notice

Specifications of the products displayed herein are subject to change without notice. TSC or anyone on its behalf, assumes no responsibility or liability for any errors or inaccuracies.

Information contained herein is intended to provide a product description only. No license, express or implied, to any intellectual property rights is granted by this document. Except as provided in TSC's terms and conditions of sale for such products, TSC assumes no liability whatsoever, and disclaims any express or implied warranty, relating to sale and/or use of TSC products including liability or warranties relating to fitness for a particular purpose, merchantability, or infringement of any patent, copyright, or other intellectual property right.

The products shown herein are not designed for use in medical, life-saving, or life-sustaining applications. Customers using or selling these products for use in such applications do so at their own risk and agree to fully indemnify TSC for any damages resulting from such improper use or sale.