

RoHS Compliant Product
A suffix of "-C" specifies halogen & lead-free

FEATURES

- Built-in bias resistors enable the configuration of an inverter circuit without connecting external input resistors (see equivalent circuit).
- The bias resistors consist of thin-film resistors with complete isolation to allow positive biasing of the input. They also have the advantage of almost completely eliminating parasitic effects.
- Only the on/off conditions need to be set for operation, making device design easy.

EQUIVALENT CIRCUIT

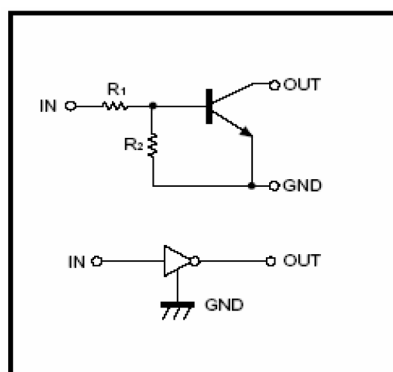

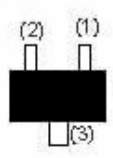
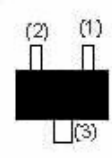
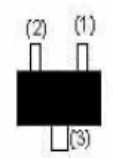
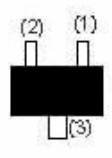
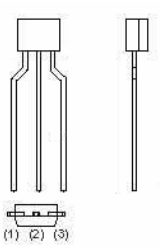
<p>DTC143XE (SOT-523)</p>  <p>1.IN 2.GND 3.OUT</p> <p>Abbreviated symbol : 43</p>	<p>DTC143XUA (SOT-323)</p>  <p>1.IN 2.GND 3.OUT</p> <p>Abbreviated symbol : 43</p>
<p>DTC143XM (SOT-723)</p>  <p>1.IN 2.GND 3.OUT</p> <p>Abbreviated symbol : 43</p>	<p>DTC143XCA (SOT-23)</p>  <p>1.IN 2.GND 3.OUT</p> <p>Abbreviated symbol : 43</p>
<p>DTA143XSA (TO-92S)</p>  <p>1.GND 2.OUT 3.IN</p>	

ABSOLUTE MAXIMUM RATINGS (T_A=25°C unless otherwise noted)

Parameter	Symbol	Limits (DTC143X□)					Unit
		M	E	UA	CA	SA	
Collector-Base Voltage	V _{CC}	50					V
Input voltage	V _{IN}	-7~20					V
Output current	I _O	100					mA
	I _{C(MAX)}	100					
Power dissipation	P _D	100	150	200	300	mW	
Junction & Storage temperature	T _J , T _{STG}	150, -55~150					°C

ELECTRICAL CHARACTERISTICS ($T_A=25^\circ\text{C}$ unless otherwise noted)

Parameter	Symbol	Min.	Typ.	Max.	Unit	Test Conditions
Input voltage	$V_{I(off)}$	0.3	-	-	V	$V_{CC}=5\text{V}$, $I_O=100\mu\text{A}$
	$V_{I(on)}$	-	-	2.5		$V_O=0.3\text{V}$, $I_O=20\text{mA}$
Output voltage	$V_{O(on)}$	-	0.1	0.3	V	$I_O/I_I=10\text{mA}/0.5\text{mA}$
Input current	I_I	-	-	1.8	mA	$V_I=5\text{V}$
Output current	$I_{O(off)}$	-	-	0.5	μA	$V_{CC}=50\text{V}$, $V_I=0$
DC current gain	G_I	30	-	-		$V_O=5\text{V}$, $I_O=10\text{mA}$
Input resistance	R_1	3.29	4.7	6.11	K Ω	
Resistance ratio	R_2/R_1	1.7	2.1	2.6		
Transition frequency	f_T	-	250	-	MHz	$V_O=10\text{V}$, $I_O=5\text{mA}$, $f=100\text{MHz}$

CHARACTERISTIC CURVES

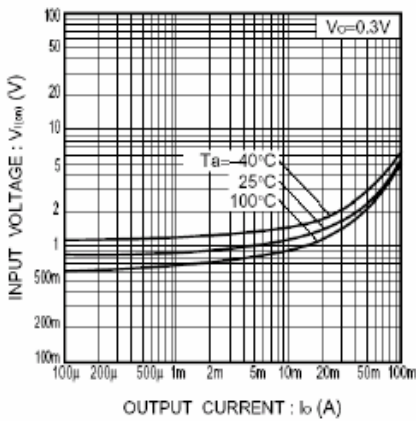

Fig.1 Input voltage vs. output current (ON characteristics)

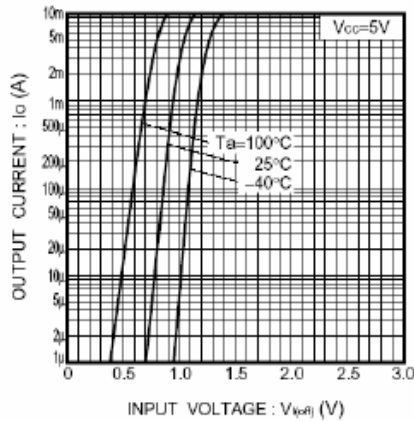

Fig.2 Output current vs. input voltage (OFF characteristics)

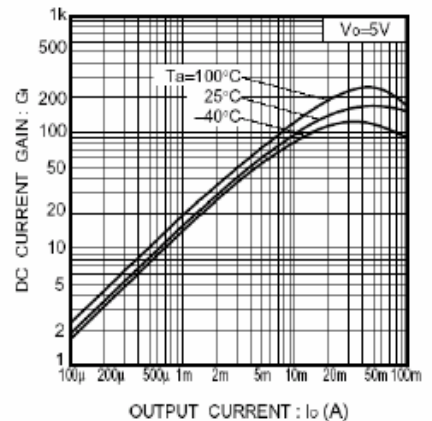

Fig.3 DC current gain vs. output current

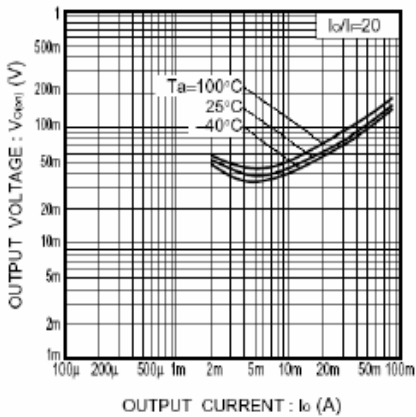

Fig.4 Output voltage vs. output current