

FEATURES

- * Built-in bias resistors enable the configuration of an inverter circuit without connecting input external resistors (see equivalent circuit).
- * Only the on/off conditions need to be set for operation, making device design easy.
- * The bias resistors consist of thin-film resistors with complete isolation to allow negative biasing of the input. They also have the advantage of almost completely eliminating parasitic effects.

●Equivalent circuit

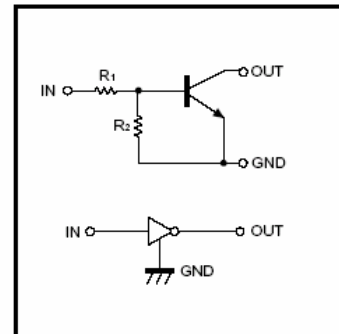

PIN CONNECTIONS AND MARKING

DTC143ZE



SOT-523

Abbreviated symbol: E23

DTC143ZUA



SOT-323

Abbreviated symbol: E23

DTC143ZKA

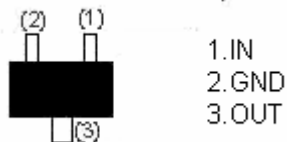

SOT-23-3L

Abbreviated symbol: E23

DTC143ZCA

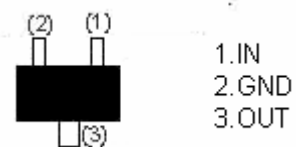

SOT-23

Abbreviated symbol: E23

DTC143ZSA

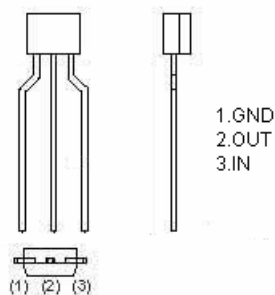

TO-92S

Absolute maximum ratings(Ta=25°C)

Parameter	Symbol	Limits (DTC143□)					Unit
		E	UA	CA	KA	SA	
Collector-base voltage	$V_{(BR)CBO}$			50			V
Collector-emitter voltage	$V_{(BR)CEO}$			50			V
Emitter-base voltage	$V_{(BR)EBO}$			5			V
Collector current	I_C			100			mA
Collector Power dissipation	P_C	150		200		300	mW
Junction temperature	T_j			150			°C
Storage temperature	T_{stg}			-55~150			°C

Electrical characteristics (Ta=25°C)

Parameter	Symbol	Min.	Typ	Max.	Unit	Conditions
Input voltage	$V_{I(off)}$			0.5	V	$V_{CC}=5V, I_O=100\mu A$
	$V_{I(on)}$	1.3				$V_O=0.3V, I_O=5mA$
Output voltage	$V_{O(on)}$		0.1	0.3	V	$I_O/I_I=5mA/0.25mA$
Input current	I_I			1.8	mA	$V_I=5V$
Output current	$I_{O(off)}$			0.5	μA	$V_{CC}=50V, V_I=0$
DC current gain	G_I	80				$V_O=5V, I_O=10mA$
Input resistance	R_1	3.29	4.7	6.11	K Ω	
Resistance ratio	R_2/R_1	8	10	12		
Transition frequency	f_T		250		MHz	$V_{CE}=10V, I_E=-5mA, f=100MHz$

Typical Characteristics

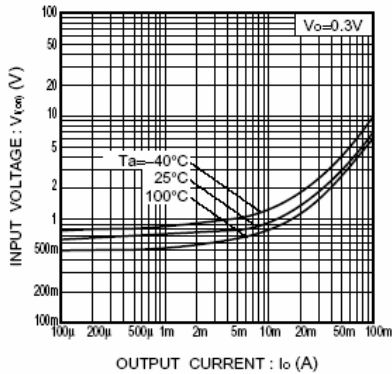

Fig.1 Input voltage vs. output current (ON characteristics)

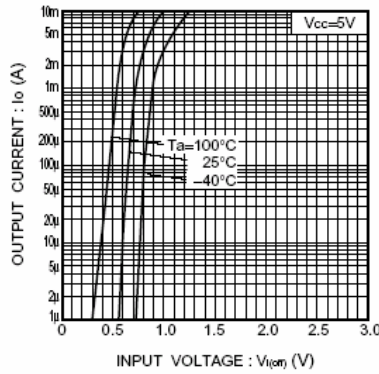

Fig.2 Output current vs. input voltage (OFF characteristics)

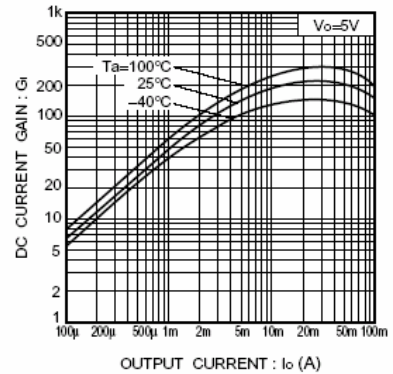

Fig.3 DC current gain vs. output current

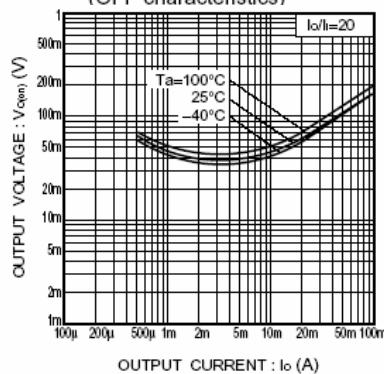

Fig.4 Output voltage vs. output current