



# DTC144E

## NPN SILICON TRANSISTOR

### NPN DIGITAL TRANSISTOR (BUILT-IN BIAS RESISTORS)

#### FEATURES

- \* Built-in bias resistors that implies easy ON/OFF applications.
- \* The bias resistors are thin-film resistors with complete isolation to allow negative input.

#### EQUIVALENT CIRCUIT

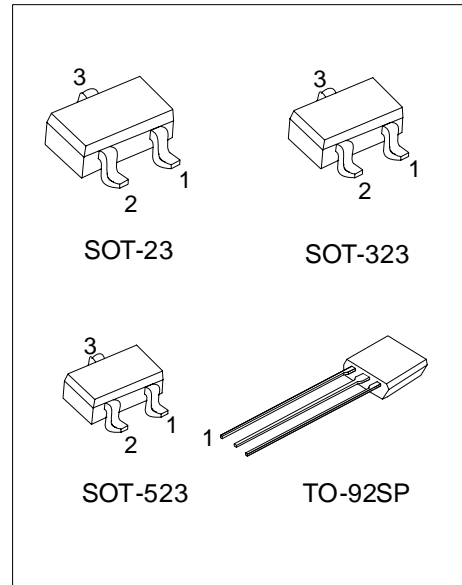
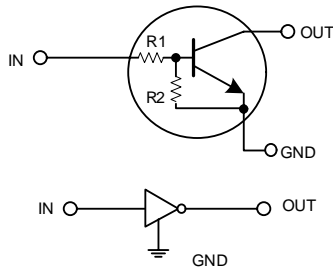

\*Pb-free plating product number:DTC144EL

#### ORDERING INFORMATION

Order Number		Package	Pin Assignment			Packing
Normal	Lead Free Plating		1	2	3	
DTC144E-AE3-R	DTC144EL-AE3-R	SOT-23	G	I	O	Tape Reel
DTC144E-AL3-R	DTC144EL-AL3-R	SOT-323	G	I	O	Tape Reel
DTC144E-AN3-R	DTC144EL-AN3-R	SOT-523	G	I	O	Tape Reel
DTC144E-T9S-R	DTC144EL-T9S-R	TO-92SP	G	O	I	Tape Reel

<p>DTC144EL-AE3-R</p> <p>(1)Packing Type (2)Package Type (3)Lead Plating</p>	<p>(1) R: Tape Reel (2) AE3: SOT-23, AL3: SOT-323, AN3: SOT-523 (3) L: Lead Free Plating, Blank: Pb/Sn</p>
--	--

#### MARKING(For SOT Package)

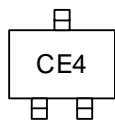

■ ABSOLUTE MAXIMUM RATINGS (Ta = 25 )

PARAMETER		SYMBOL	RATINGS	UNIT
Supply Voltage		V <sub>CC</sub>	50	V
Input Voltage		V <sub>IN</sub>	-10 ~ +12	V
Output Current		I <sub>OUT</sub>	100	mA
		I <sub>OUT(MAX)</sub>	100	mA
Power Dissipation	TO-92SP	P <sub>C</sub>	300	mW
	SOT-523		150	mW
	SOT-23/SOT-323		200	mW
Junction Temperature		T <sub>J</sub>	+150	
Storage Temperature		T <sub>STG</sub>	-55~+150	

Note Absolute maximum ratings are those values beyond which the device could be permanently damaged.

Absolute maximum ratings are stress ratings only and functional device operation is not implied.

■ ELECTRICAL CHARACTERISTICS (Ta= 25 , unless otherwise specified)

PARAMETER	SYMBOL	TEST CONDITIONS	MIN	TYP	MAX	UNIT
Input Voltage	V <sub>IN(OFF)</sub>	V <sub>CC</sub> = 5V, I <sub>OUT</sub> =100 μ A			0.5	V
	V <sub>IN(ON)</sub>	V <sub>OUT</sub> = 0.3V, I <sub>OUT</sub> = 20mA	3			
Output Voltage	V <sub>OUT(ON)</sub>	I <sub>OUT</sub> /I <sub>IN</sub> = 10mA / 0.5 mA			0.3	V
Input Current	I <sub>IN</sub>	V <sub>IN</sub> = 5V			0.18	mA
Output Current	I <sub>OUT(OFF)</sub>	V <sub>CC</sub> = 50V , V <sub>IN</sub> =0V			0.5	μ A
DC Current Gain	h <sub>FE</sub>	V <sub>OUT</sub> = 5V, I <sub>OUT</sub> = 5mA	68			
Input Resistance	R1		32.9	47	61.1	k
Resistance Ratio	R2/R1		0.8	1	1.2	
Transition Frequency	f <sub>T</sub>	V <sub>CE</sub> = 10 V, I <sub>E</sub> = -5mA, f=100MHz		250		MHz

## TYPICAL CHARACTERISTICS

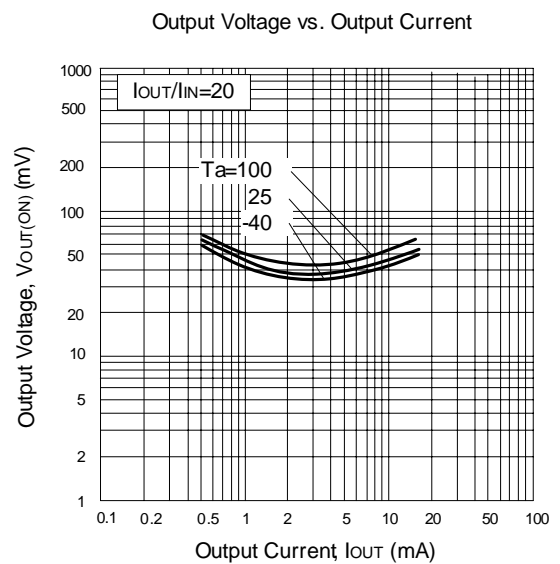
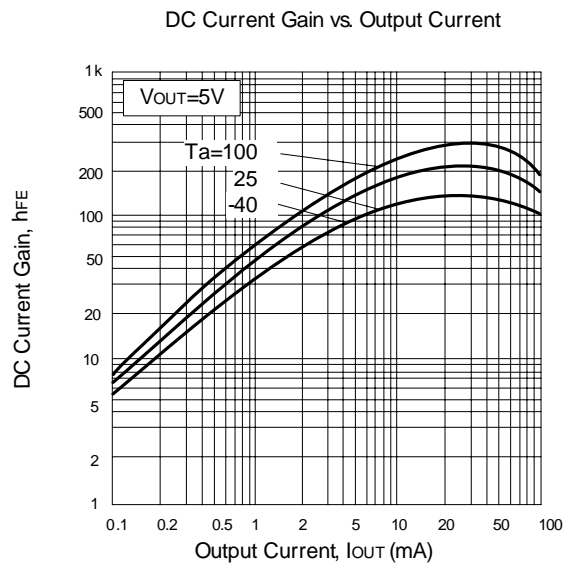
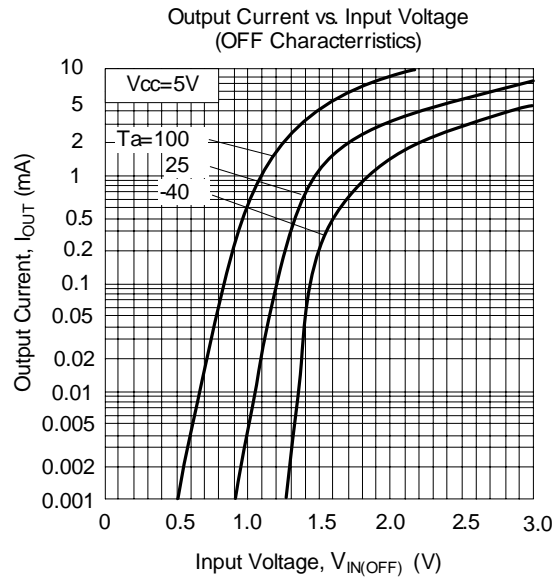
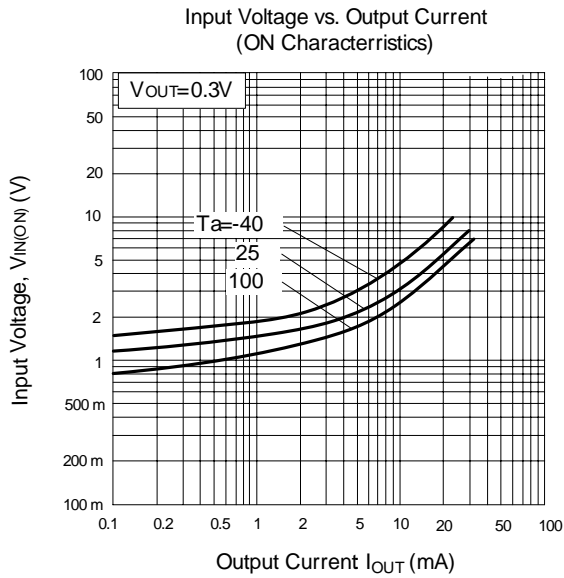

UTC assumes no responsibility for equipment failures that result from using products at values that exceed, even momentarily, rated values (such as maximum ratings, operating condition ranges, or other parameters) listed in products specifications of any and all UTC products described or contained herein. UTC products are not designed for use in life support appliances, devices or systems where malfunction of these products can be reasonably expected to result in personal injury. Reproduction in whole or in part is prohibited without the prior written consent of the copyright owner. The information presented in this document does not form part of any quotation or contract, is believed to be accurate and reliable and may be changed without notice.