

SBD Type : EA20QC10

OUTLINE DRAWING

FEATURES

- * TO-251AA Case
- * Dual Diodes Cathode Common
- * Low Forward Voltage drop
- * Low Power Loss
- * High Surge Capability
- * 40 Volts thru 100 Volts Types Available

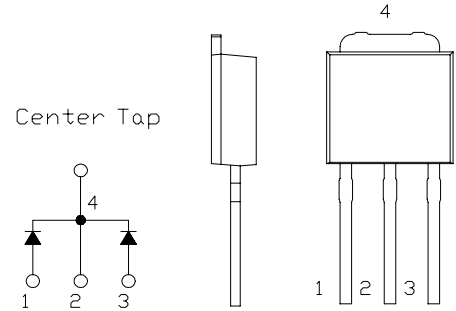

Maximum Ratings

Approx Net Weight:0.35g

Rating		Symbol	EA20QC10			Unit
Repetitive Peak Reverse Voltage		V_{RRM}	100			V
Average Rectified Output Current	P.C.Board mounted *	I_O	1.6	$T_a=32^{\circ}C$	50Hz Full Sine Wave Resistive Load	A
	-		2	$T_c=138^{\circ}C$		
RMS Forward Current		$I_{F(RMS)}$	2.22			A
Surge Forward Current		I_{FSM}	20	50Hz Full Sine Wave, 1cycle, Non-repetitive		A
Operating Junction Temperature Range		T_{jw}	- 40 to + 150			$^{\circ}C$
Storage Temperature Range		T_{stg}	- 40 to + 150			$^{\circ}C$

Electrical • Thermal Characteristics

Characteristics		Symbol	Conditions	Min	Typ	Max	Unit
Peak Reverse Current		I_{RM}	$T_j=25^{\circ}C, V_{RM}=V_{RRM}$ per Arm	-	-	0.5	mA
Peak Forward Voltage		V_{FM}	$T_j=25^{\circ}C, I_{FM}= 1 A$ per Arm	-	-	0.85	V
Thermal Resistance	Junction to Ambient	$R_{th(j-a)}$	P.C.Board mounted *	-	-	80	$^{\circ}C/W$
	Junction to Case	$R_{th(j-c)}$	-	-	-	6	$^{\circ}C/W$

* Print Land = 20x20 mm

EA20QC10 OUTLINE DRAWING (Dimensions in mm)

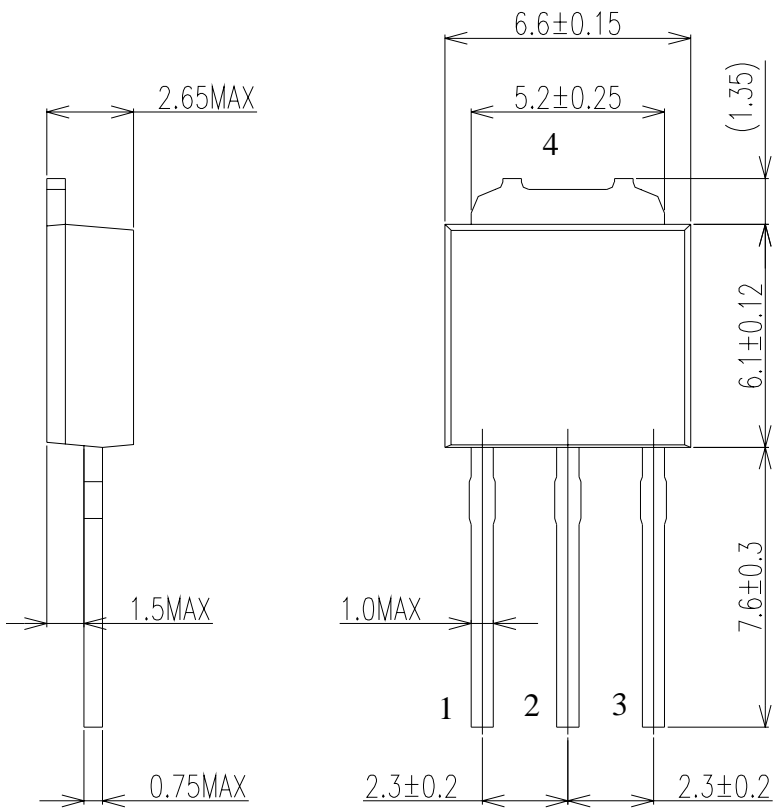

Center Tap

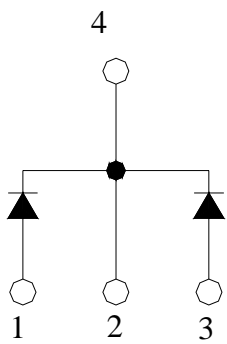

FORWARD CURRENT VS. VOLTAGE

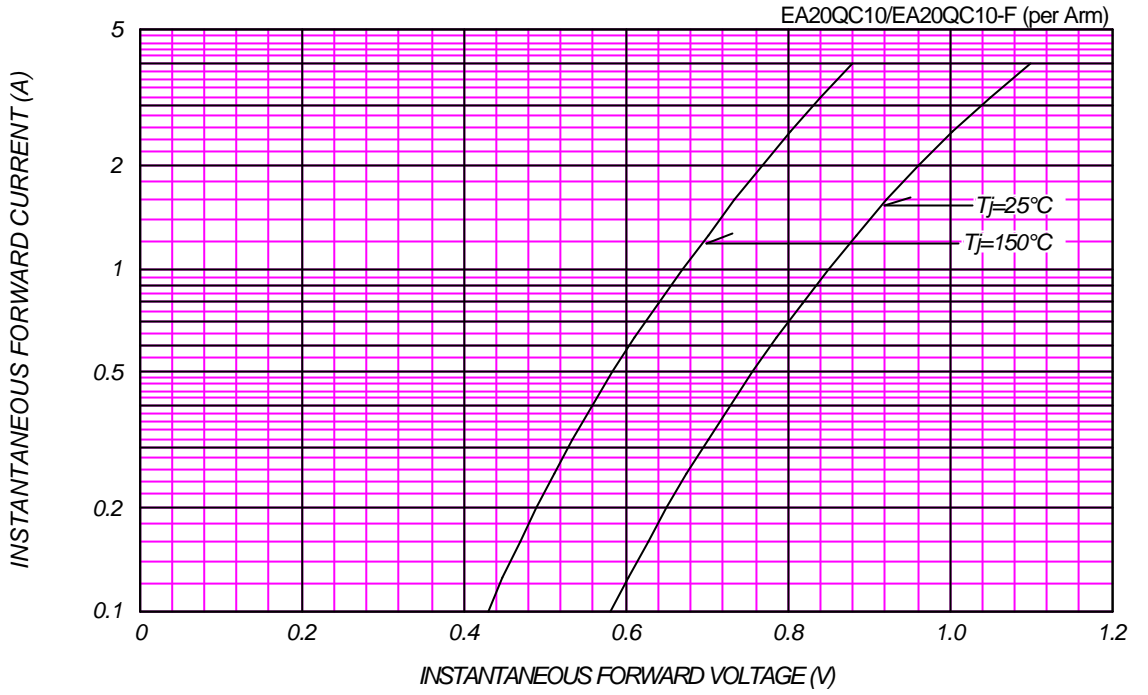

AVERAGE FORWARD POWER DISSIPATION

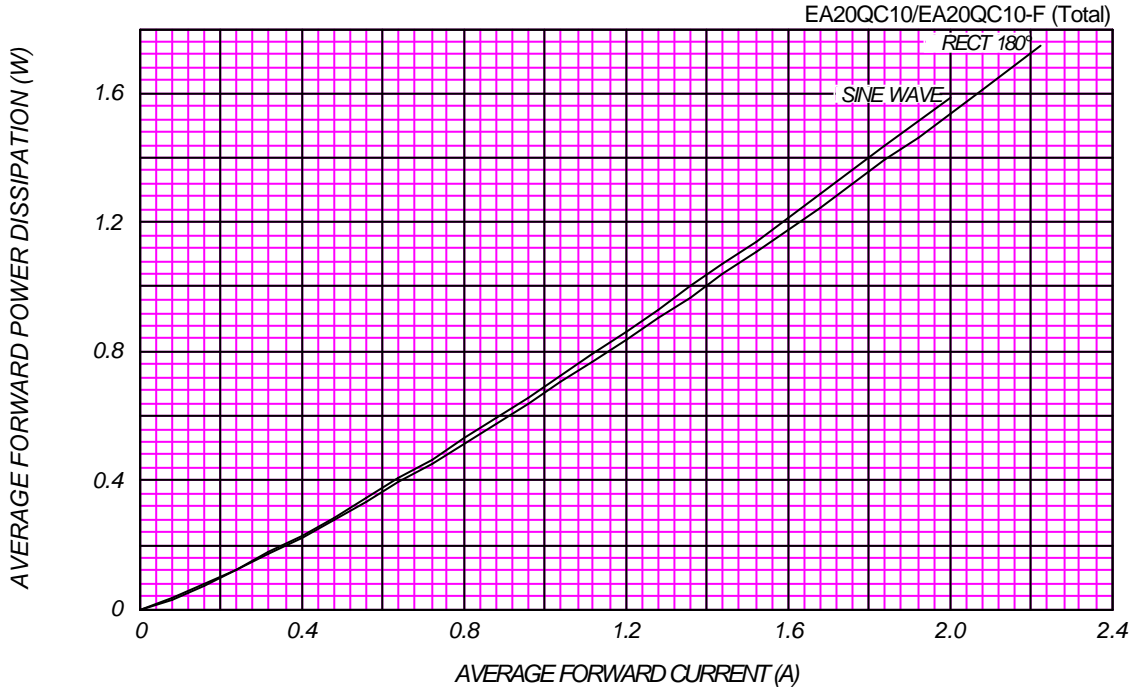

PEAK REVERSE CURRENT VS. PEAK REVERSE VOLTAGE

$T_j = 150\text{ }^\circ\text{C}$

EA20QC10/EA20QC10-F (per Arm)

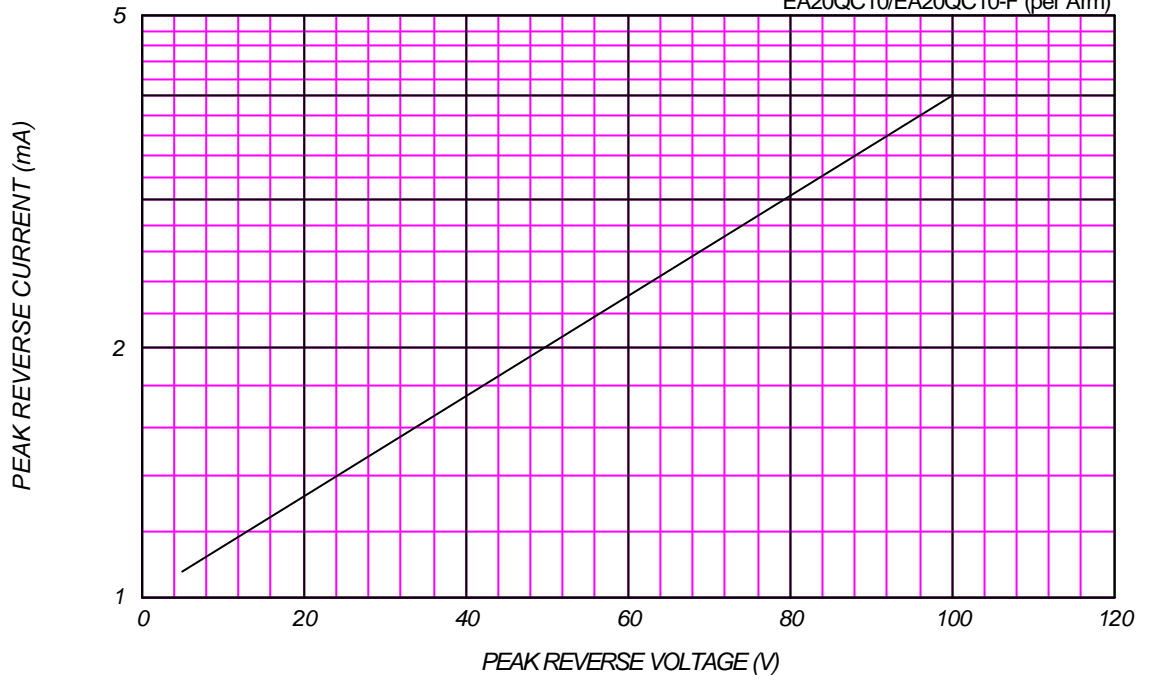

AVERAGE REVERSE POWER DISSIPATION

EA20QC10/EA20QC10-F (Total)

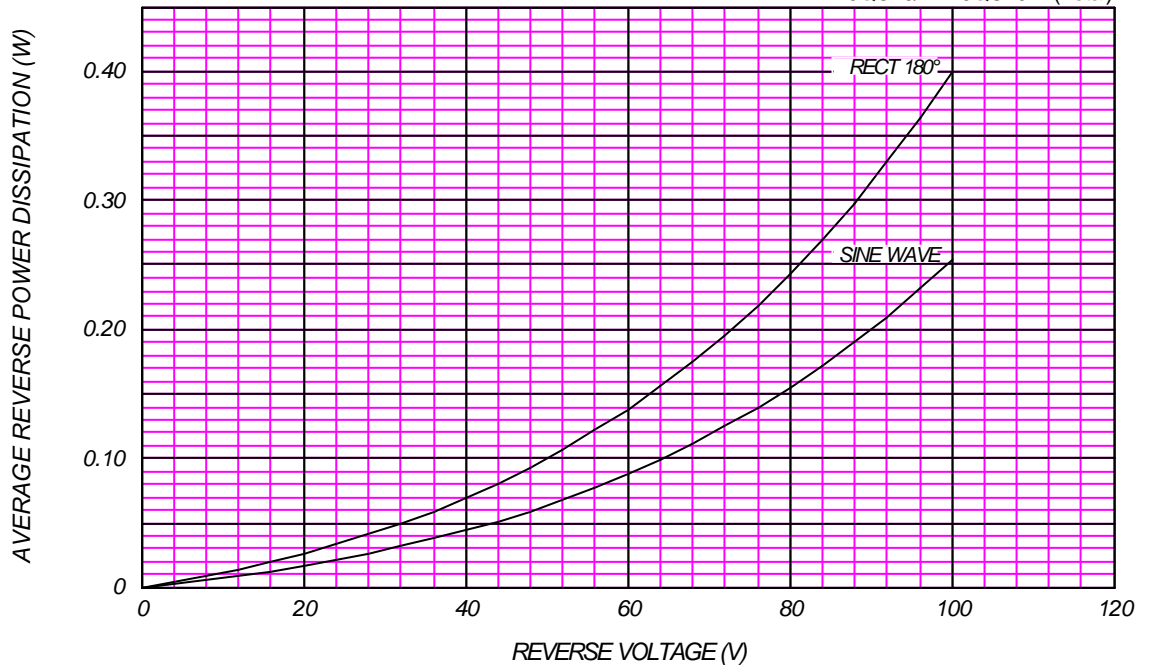



AVERAGE FORWARD CURRENT VS. CASE TEMPERATURE

$V_{RM}=100V$

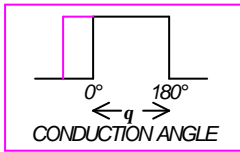
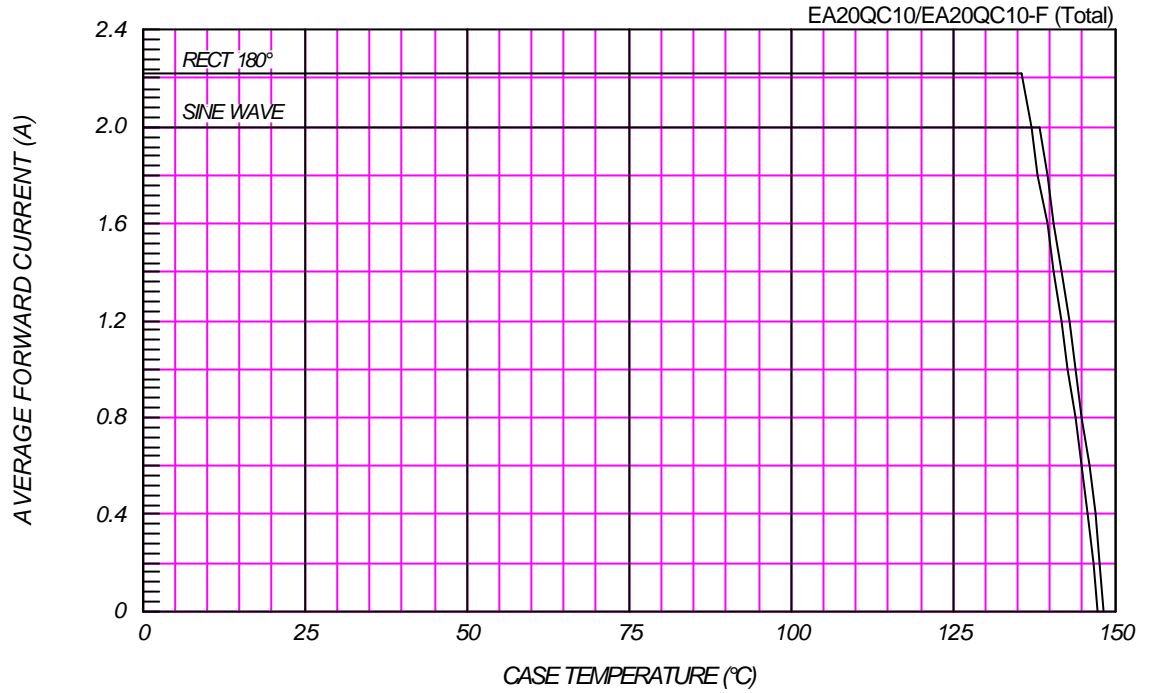

AVERAGE FORWARD CURRENT VS. AMBIENT TEMPERATURE

P.C. Board mounted (Print land=20x20mm)

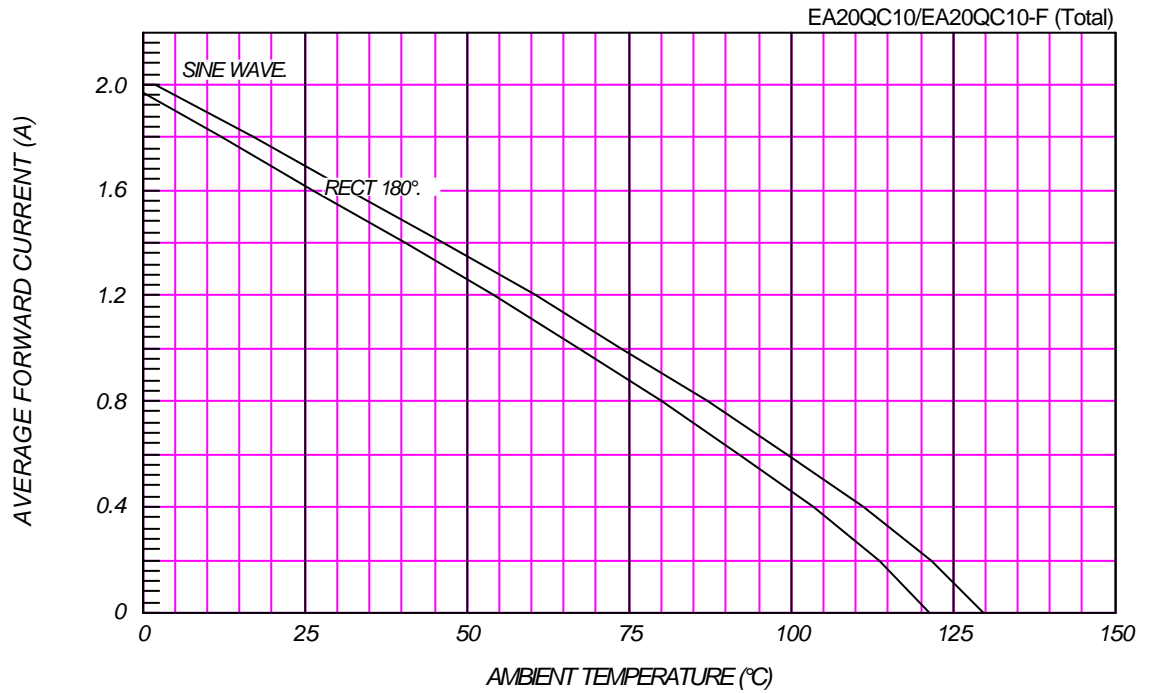

SURGE CURRENT RATINGS

f=50Hz,Sine Wave,Non-Repetitive,No Load

EA20QC10/EA20QC10-F

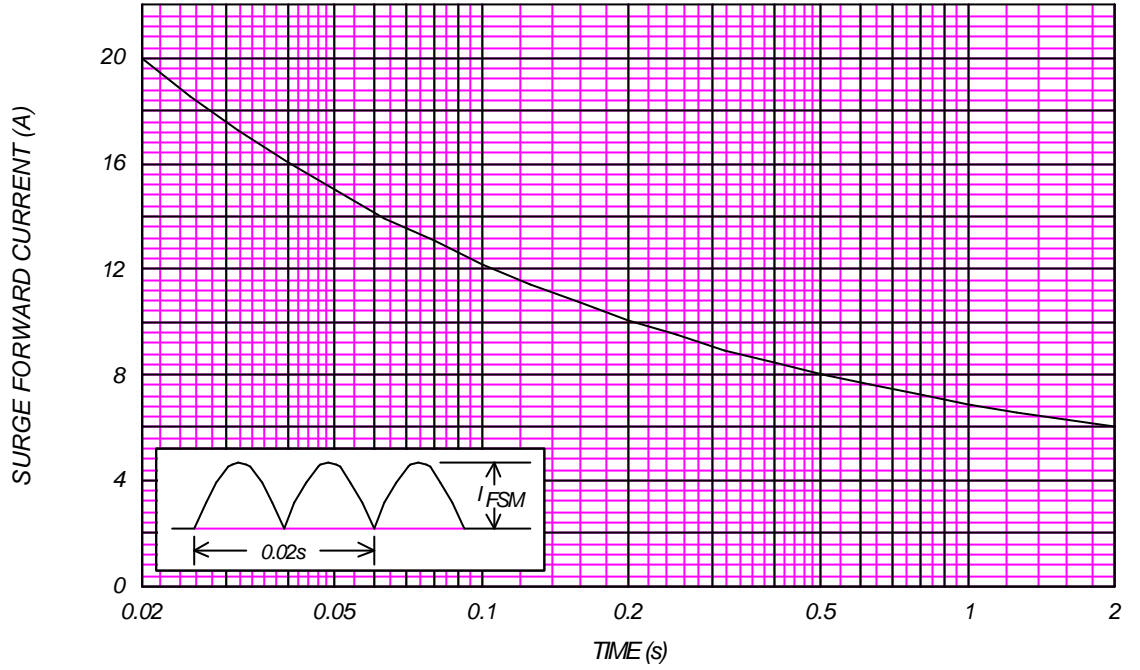

JUNCTION CAPACITANCE VS. REVERSE VOLTAGE

$T_j=25^\circ\text{C}, V_m=20\text{mV}_{\text{RMS}}, f=100\text{kHz}$, Typical Value

EA20QC10/EA20QC10-F (per Arm)

