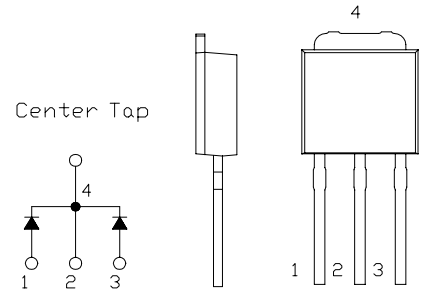

**6A 200V**
**SBD Type : ECH06A20**

OUTLINE DRAWING

構造 : ショットキーバリアダイオード(SBD)  
 Construction: Schottky barrier Diode  
 カソード コモン型

用途 : 高周波整流用  
 Application : High Frequency Rectification

**最大定格 / Maximum Ratings**

Approx Net Weight:0.35g

Rating	Symbol	ECH06A20		Unit
くり返しピーク逆電圧 Repetitive Peak Reverse Voltage	$V_{RRM}$	200		V
平均整流電流 Average Rectified Output Current	$I_0$	6.0	$T_c=116$ 50 Hz, 正弦全波通電、抵抗負荷 Full Sine Wave Resistive Load	A
		1.0	同上 基盤実装時 P.C.Board mounted	
実効順電流 RMS Forward Current	$I_{F(RMS)}$	6.66		A
サージ順電流 Surge Forward Current	$I_{FSM}$	60	50 Hz 正弦全波, 1サイクル, 非くり返し Full Sine Wave, 1cycle, Non-repetitive	A
動作接合温度範囲 Operating Junction Temperature Range	$T_{jw}$	- 40 ~ + 150		
保存温度範囲 Storage Temperature Range	$T_{stg}$	- 40 ~ + 150		

**電氣的・熱的特性 / Electrical・Thermal Characteristics**

Characteristics	Symbol	Conditions	Min	Typ	Max.	Unit
ピーク逆電流 Peak Reverse Current	$I_{RM}$	$T_j=25$ , $V_{RM}=V_{RRM}$ per Diode	-	-	200	$\mu A$
ピーク順電圧 Peak Forward Voltage	$V_{FM}$	$T_j=25$ , $I_{FM}= 3A$ per Diode	-	-	0.90	V
熱抵抗 Thermal Resistance	$R_{th(j-c)}$	接合部・ケース間 Junction to Case	-	-	5	/W
	$R_{th(j-a)}$	接合部・周囲間 (基盤実装時) Junction to Ambient (with P.C.Board mounted)			80	

ECH06A \*外形図 (mm)

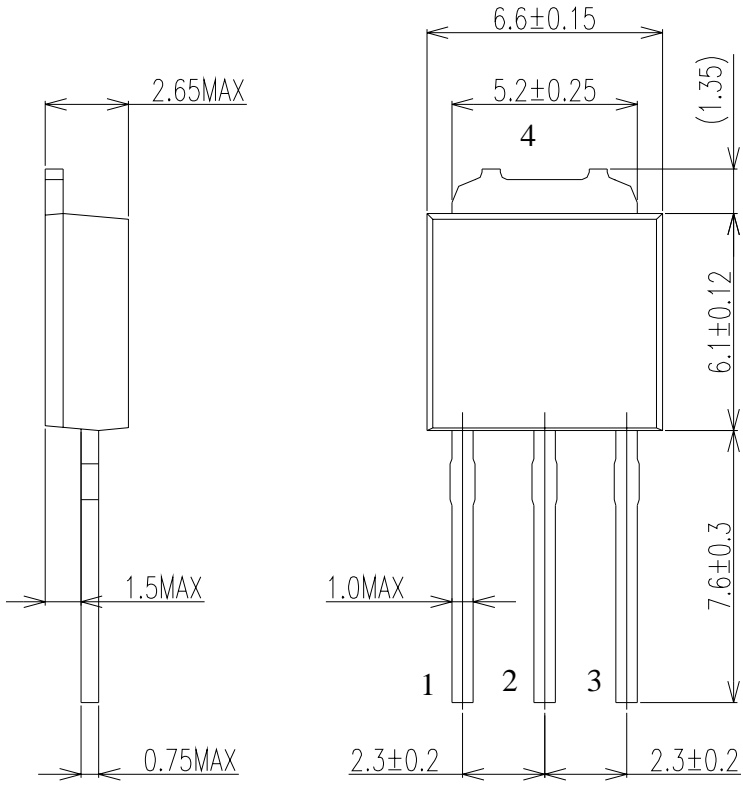

Center Tap

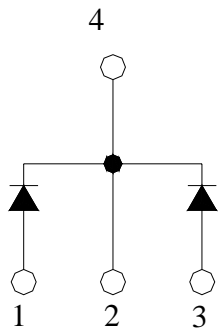

順電压特性  
FORWARD CURRENT VS. VOLTAGE

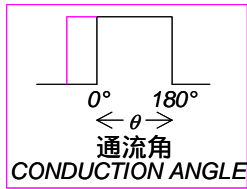
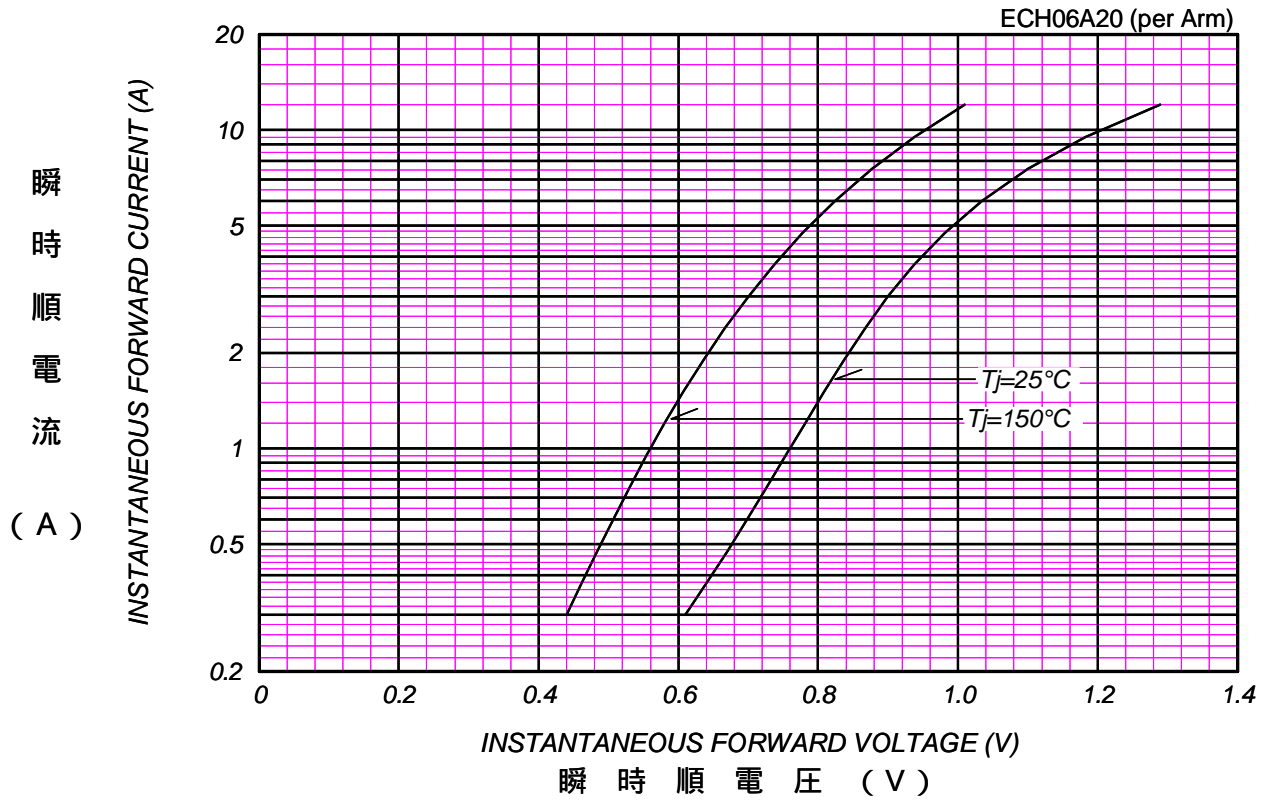

平均順電力損失特性  
AVERAGE FORWARD POWER DISSIPATION

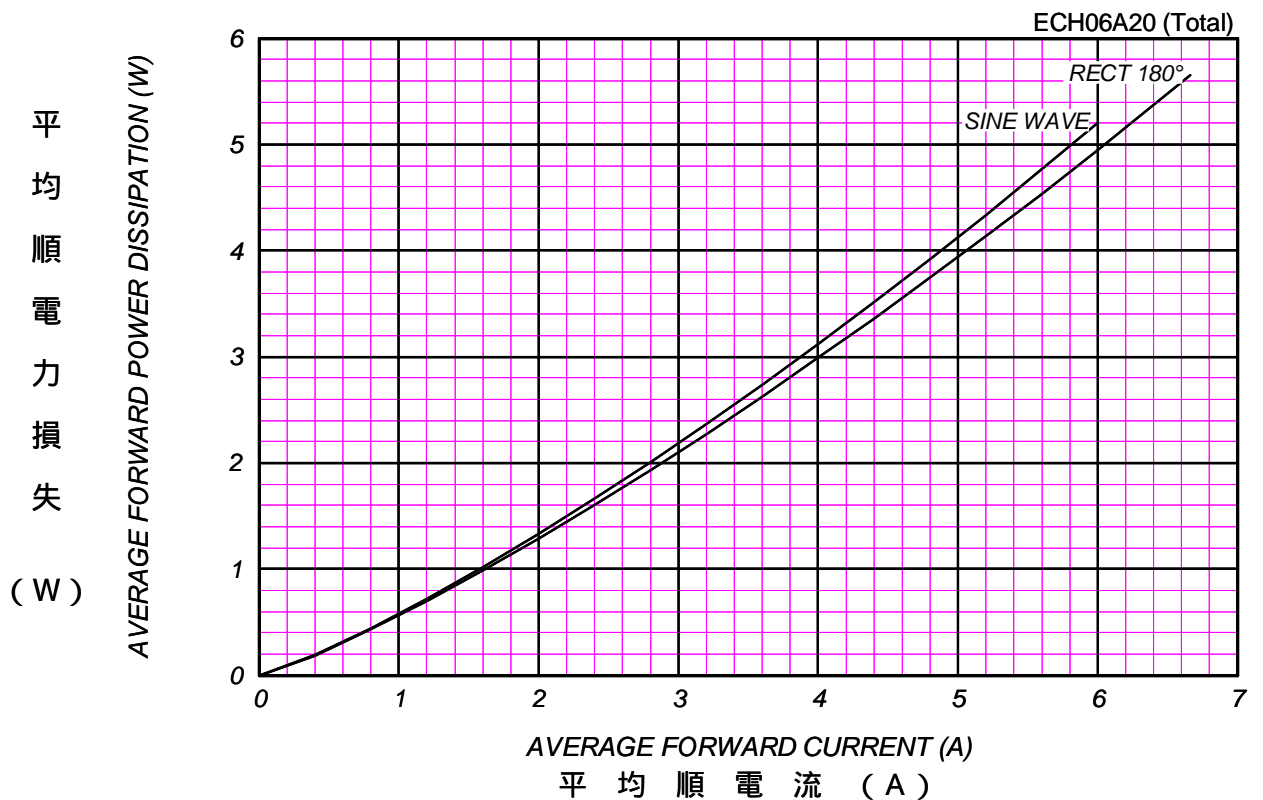

ピーク逆電流 - ピーク逆電圧特性  
 PEAK REVERSE CURRENT VS. PEAK REVERSE VOLTAGE

T<sub>j</sub> = 150 °C

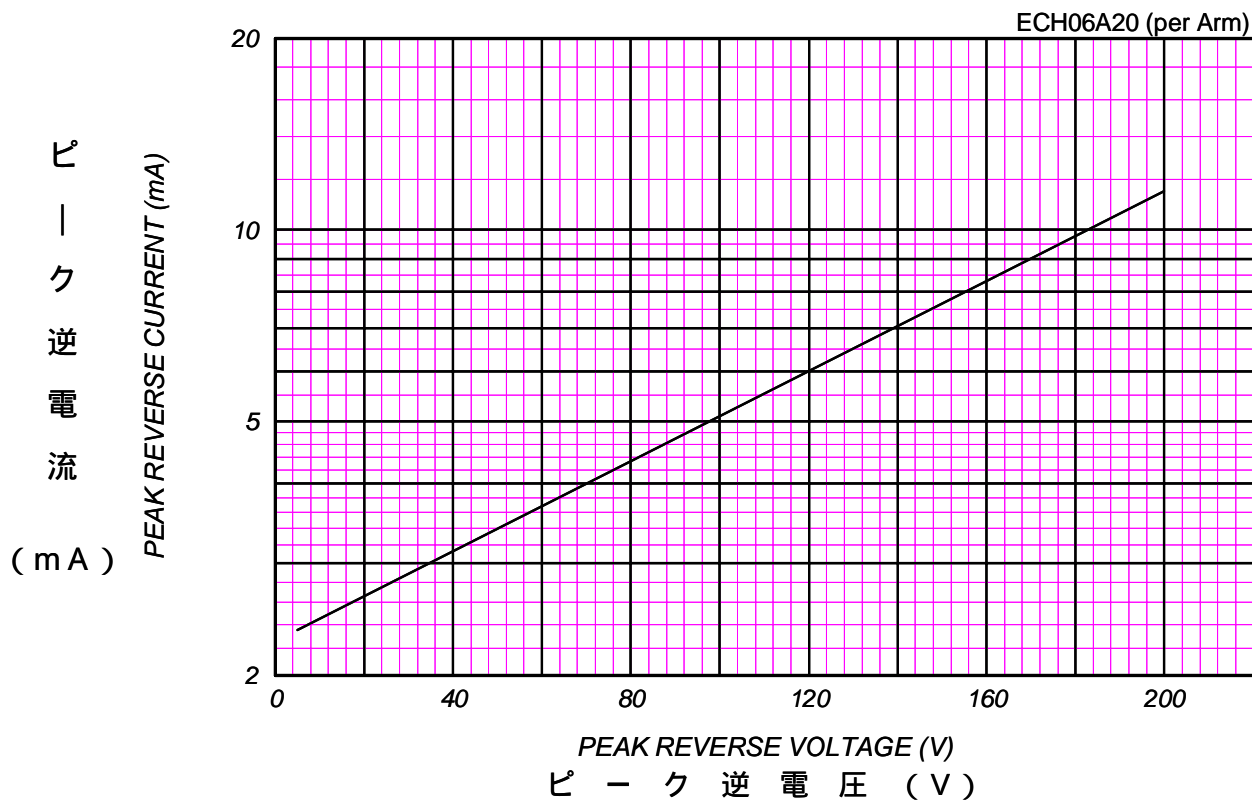

平均逆電力損失  
 AVERAGE REVERSE POWER DISSIPATION

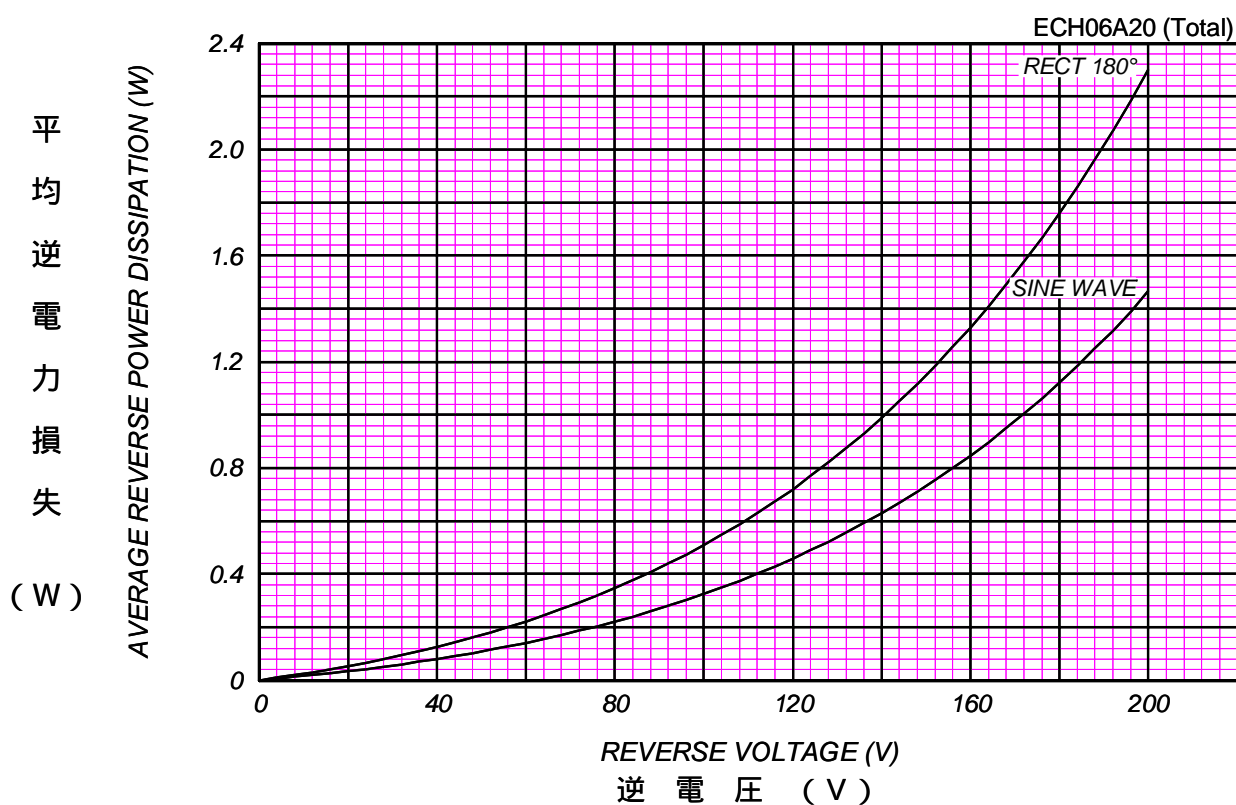

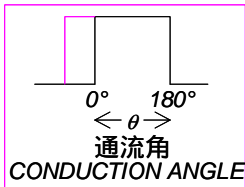

平均順電流 - ケース温度定格  
 AVERAGE FORWARD CURRENT VS. CASE TEMPERATURE

$V_{RM}=200V$

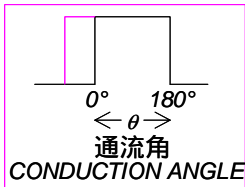
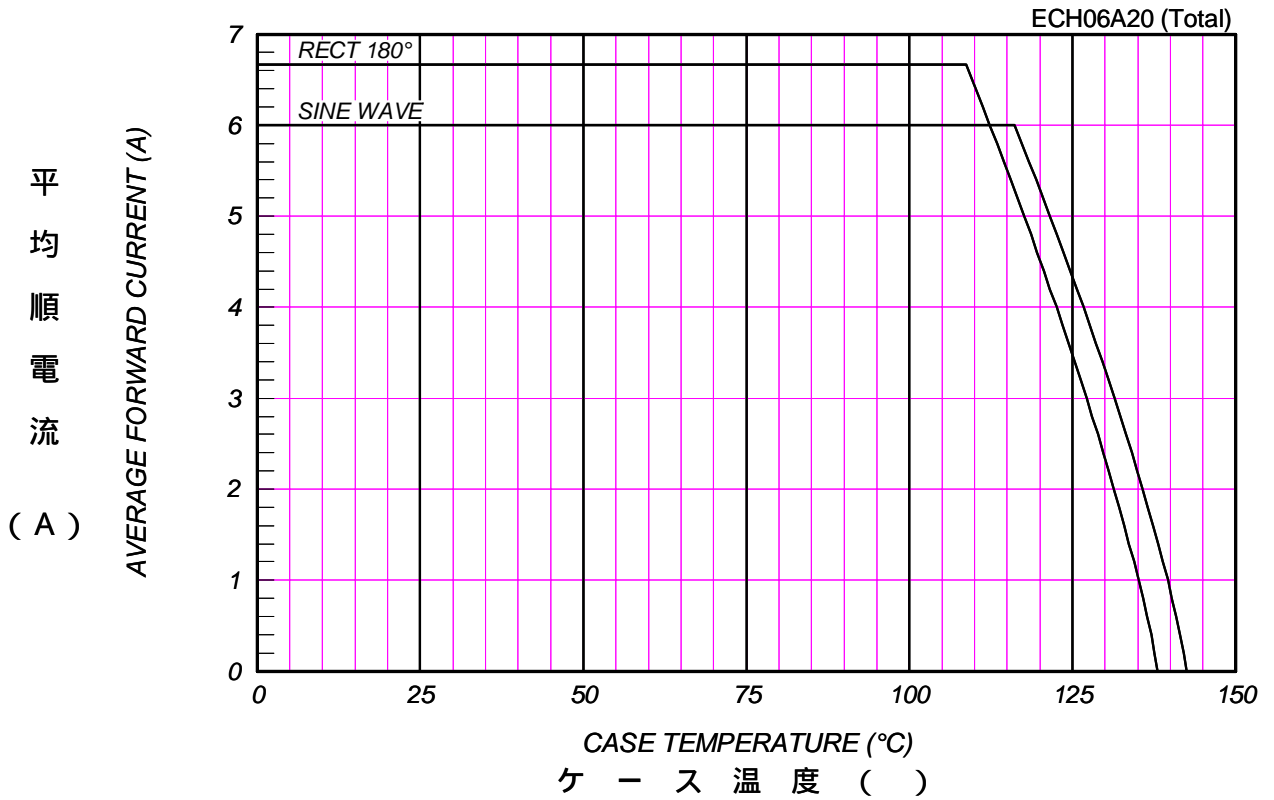

平均順電流 - 周囲温度定格  
 AVERAGE FORWARD CURRENT VS. AMBIENT TEMPERATURE

P.C. Board mounted(Print land=20x20mm),  $V_{RM}=200V$

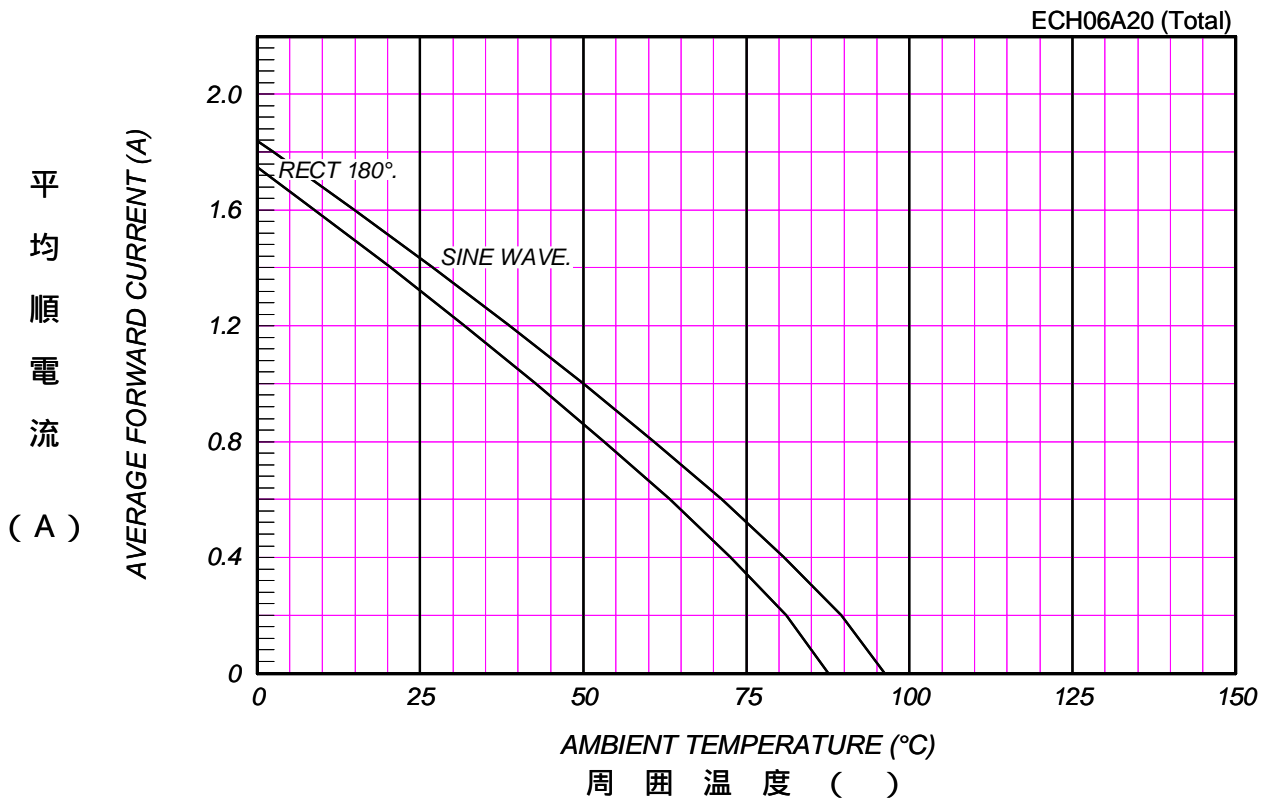

# サージ順電流定格 SURGE CURRENT RATINGS

f=50Hz,Sine Wave,Non-Repetitive,No Load

ECH06A20

サ  
ー  
ジ  
順  
電  
流  
  
(A)

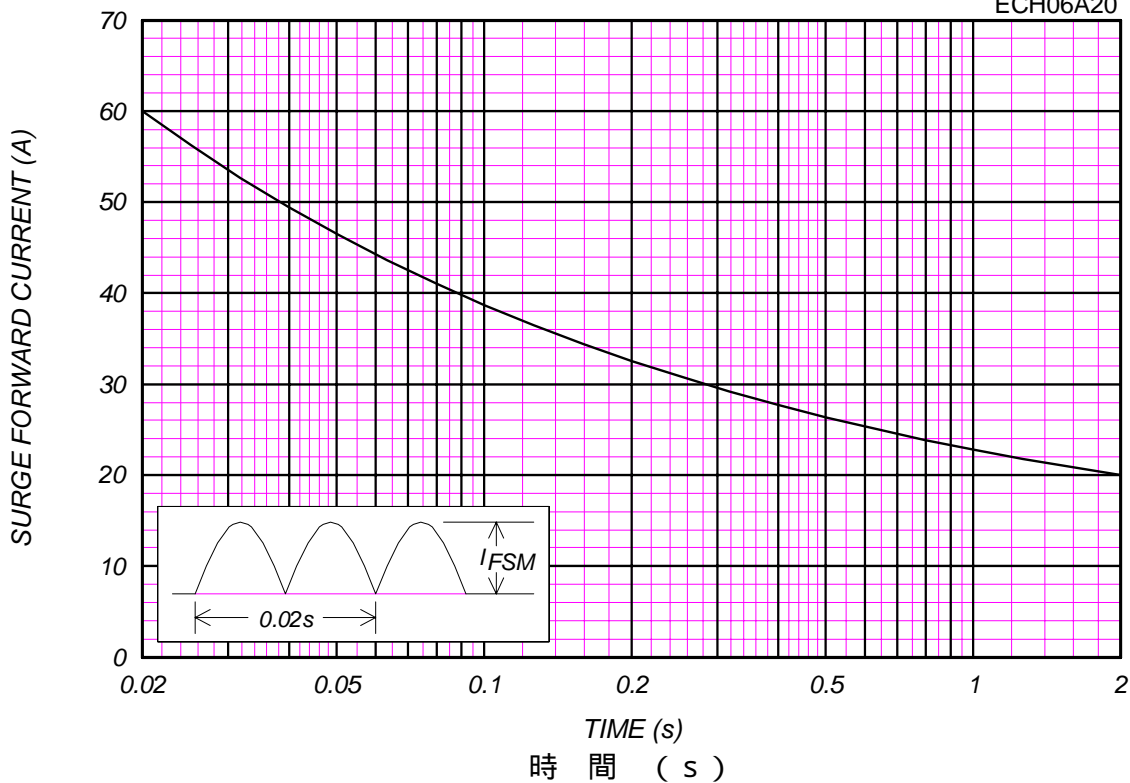

# 接合容量特性 JUNCTION CAPACITANCE VS. REVERSE VOLTAGE

T<sub>j</sub>=25°C,V<sub>m</sub>=20mV<sub>RMS</sub>,f=100kHz,Typical Value

ECH06A20 (per Arm)

接  
合  
容  
量  
  
(pF)

