

Film Chip Capacitor

Type: **ECWU(C)**

Stacked metallized PEN film as dielectric with simple mold - less construction

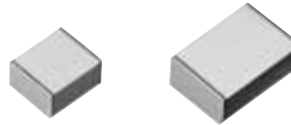

■ Features

- ◆ Small in size
- ◆ Applicable for reflow soldering

■ Recommended Applications

- ◆ Coupling
- ◆ By - pass
- ◆ General purpose

■ Explanation of Part Numbers

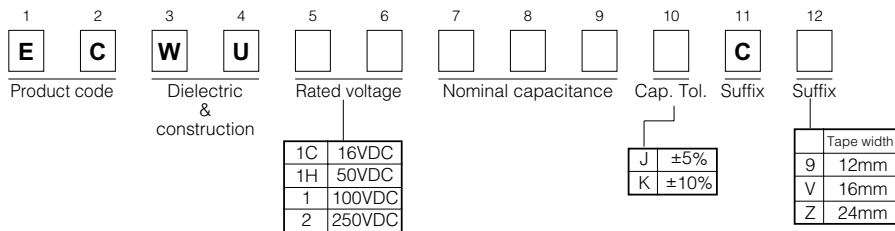

■ Specifications

| | | |
|-----------------------|---|---|
| Category temp.range | 16VDC, 50VDC: - 55 to + 105°C | |
| | 100VDC, 250VDC: - 40 to + 85°C | |
| Rated voltage | 16VDC, 50VDC, 100VDC, 250VDC | |
| Capacitance range | 16VDC | 0.12 to 0.47 μF (E12) |
| | 50VDC | 0.056 to 0.22 μF (E12) |
| | 100VDC | 0.012 to 1.0 μF (E12) |
| | 250VDC | 0.001 to 1.0 μF (E12) |
| Capacitance tolerance | 16VDC,50VDC | ± 5%(J) |
| | 100VDC,250VDC | ± 10%(K) (100VDC, C≦0.15 μF ± 5%(J), ± 10%(K)) |
| Withstand voltage | Between terminals 16VDC, 50VDC:Rated volt. (VDC)×175% 1 to 5s 100VDC, 250VDC:Rated volt. (VDC)×150% 60s | |
| Dissipation factor | ≤ 1.0%(20°C,1kHz) | |
| Insulation resistance | C ≤ 0.33 μF | 16VDC:≥ 3000MΩ • (20°C,10VDC, 60s) 50VDC:≥ 3000MΩ • (20°C,50VDC, 60s) 100VDC, 250VDC:≥ 3000MΩ • (20°C,100VDC,60s) |
| | C > 0.33 μF | 16VDC:1000MΩ • μF min. (20°C,10VDC, 60s) 100VDC, 250VDC:1000MΩ • μF min. (20°C,100VDC,60s) |
| Soldering conditions | Reflow soldering 16VDC, 50VDC:240°C max. and 30 sec max. at more than 210°C (Temp. at cap. surface) 100VDC, 250VDC:230°C max. and 30 sec max.at more than 210°C (Temp.at cap.surface) | |

■ Construction

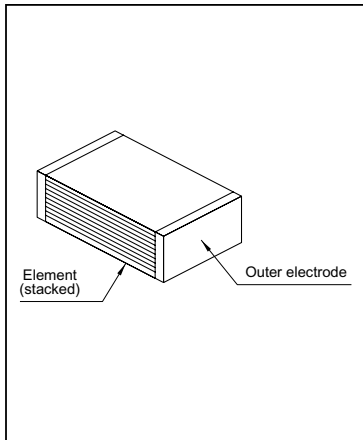

■ Dimensions in mm (not to scale)

| Size code | L | Tol. | W | Tol. | H | Tol. |
|-----------|------|-------|------|-------|-----|-------|
| E1 | 4.8 | | 3.3 | | 1.4 | |
| E2 | 4.8 | | 3.3 | | 2.0 | |
| E3a | 4.8 | | 3.3 | | 2.4 | |
| E3 | 4.8 | | 3.3 | | 2.8 | |
| D1 | 6.0 | ± 0.2 | 4.1 | ± 0.3 | 1.8 | ± 0.2 |
| D2 | 6.0 | | 4.1 | | | |
| D3 | 6.0 | | 4.1 | | | |
| D4 | 6.0 | | 4.1 | | | |
| D5 | 6.0 | | 4.1 | | | |
| B | 6.0 | | 5.0 | | | |
| Z | 7.1 | | 5.0 | | | |
| X | 7.7 | ± 0.4 | 5.5 | ± 0.4 | * | ± 0.3 |
| Y | 7.1 | | 6.3 | | | |
| V | 9.8 | | 6.3 | | | |
| U | 9.8 | ± 0.5 | 8.0 | | | |
| T | 15.2 | | 8.0 | | | |
| S | 15.2 | | 10.0 | | | |

0.35±0.2 0.35±0.2

*Refer to the column "Rating, Dimensions & Quantity".

■ Taping Specification for Automatic Insertion(Mounting)

Refer to the PDF file of taping specifications.

■ Rating, Dimensions & Quantity/Reel

● Capacitance tolerance : ± 5% (J)

| Cap. (μF) | Rated volt. 16VDC | | | | | | Rated volt. 50VDC | | | | | |
|--------------|-------------------|-----------------|-----|-----|-----------|--------------|-------------------|-----------------|-----|-----|-----------|------|
| | Part No | Dimensions (mm) | | | Size code | Q'ty | Part No | Dimensions (mm) | | | Size code | Q'ty |
| | | L | W | H | | | | L | W | H | | |
| 0.056 | | | | | | ECWU1H563JC9 | 4.8 | 3.3 | 2.0 | E2 | 3000 | |
| 0.068 | | | | | | ECWU1H683JC9 | 4.8 | 3.3 | 2.0 | E2 | | |
| 0.082 | | | | | | ECWU1H823JC9 | 4.8 | 3.3 | 2.4 | E3a | | |
| 0.1 | | | | | | ECWU1H104JC9 | 4.8 | 3.3 | 2.8 | E3 | | |
| 0.12 | ECWU1C124JC9 | 4.8 | 3.3 | 1.4 | E1 | 3000 | ECWU1H124JC9 | 6.0 | 4.1 | 1.8 | D1 | 3000 |
| 0.15 | ECWU1C154JC9 | 4.8 | 3.3 | 2.0 | E2 | | ECWU1H154JC9 | 6.0 | 4.1 | 2.0 | D2 | |
| 0.18 | ECWU1C184JC9 | 4.8 | 3.3 | 2.0 | E2 | 2000 | ECWU1H184JC9 | 6.0 | 4.1 | 2.4 | D3 | 2000 |
| 0.22 | ECWU1C224JC9 | 4.8 | 3.3 | 2.4 | E3a | | ECWU1H224JC9 | 6.0 | 4.1 | 2.8 | D4 | |
| 0.27 | ECWU1C274JC9 | 6.0 | 4.1 | 1.8 | D1 | 3000 | | | | | | |
| 0.33 | ECWU1C334JC9 | 6.0 | 4.1 | 2.0 | D2 | | | | | | | |
| 0.39 | ECWU1C394JC9 | 6.0 | 4.1 | 2.4 | D3 | 2000 | | | | | | |
| 0.47 | ECWU1C474JC9 | 6.0 | 4.1 | 2.8 | D4 | | | | | | | |

■ Example for Land Dimensions (mm)

| Size code | Land dimensions | | |
|--------------------|------------------|------|-----|
| | Reflow soldering | | |
| | A | B | C |
| E1, E2, E3a, E3 | 2.6 | 6.6 | 3.0 |
| D1, D2, D3, D4, D5 | 3.8 | 7.8 | 3.8 |
| B | 3.8 | 7.8 | 4.6 |
| Z | 4.5 | 9.0 | 4.6 |
| X | 5.1 | 9.7 | 5.0 |
| Y | 4.5 | 9.0 | 5.7 |
| V | 7.2 | 11.9 | 5.7 |
| U | 7.2 | 11.9 | 7.2 |
| T | 12.6 | 17.3 | 7.2 |
| S | 12.6 | 17.3 | 9.0 |

■ Rating, Dimensions & Quantity/Reel

● Capacitance tolerance : ±5%(J), ±10%(K)

| Cap. (μF) | Rated volt. 100VDC | | | | | | Rated volt. 250VDC | | | | | |
|--------------|----------------------------------|-----------------|-----|-----|-----------|-------------|--------------------|-----------------|-----|-----|-----------|------|
| | Part No | Dimensions (mm) | | | Size code | Q'ty | Part No | Dimensions (mm) | | | Size code | Q'ty |
| | | L | W | H | | | | L | W | H | | |
| 0.001 | Please use 100VDC rating ECWU(X) | | | | | | ECWU2102KC9 | 4.8 | 3.3 | 1.4 | E1 | 3000 |
| 0.0012 | | | | | | | ECWU2122KC9 | 4.8 | 3.3 | 1.4 | E1 | |
| 0.0015 | | | | | | | ECWU2152KC9 | 4.8 | 3.3 | 1.4 | E1 | |
| 0.0018 | | | | | | | ECWU2182KC9 | 4.8 | 3.3 | 1.4 | E1 | |
| 0.0022 | | | | | | | ECWU2222KC9 | 4.8 | 3.3 | 1.4 | E1 | |
| 0.0027 | | | | | | | ECWU2272KC9 | 4.8 | 3.3 | 1.4 | E1 | |
| 0.0033 | | | | | | | ECWU2332KC9 | 4.8 | 3.3 | 1.4 | E1 | |
| 0.0039 | | | | | | | ECWU2392KC9 | 4.8 | 3.3 | 1.4 | E1 | |
| 0.0047 | | | | | | | ECWU2472KC9 | 4.8 | 3.3 | 1.4 | E1 | |
| 0.0056 | | | | | | | ECWU2562KC9 | 4.8 | 3.3 | 1.4 | E1 | |
| 0.0068 | | | | | | | ECWU2682KC9 | 4.8 | 3.3 | 1.4 | E1 | |
| 0.0082 | | | | | | | ECWU2822KC9 | 4.8 | 3.3 | 1.4 | E1 | |
| 0.01 | | | | | | | ECWU2103KC9 | 4.8 | 3.3 | 1.4 | E1 | |
| 0.012 | | | | | | | ECWU1123 C9 | 4.8 | 3.3 | 1.4 | E1 | |
| 0.015 | ECWU1153 C9 | 4.8 | 3.3 | 1.4 | E1 | ECWU2153KC9 | 4.8 | 3.3 | 1.4 | E1 | | |
| 0.018 | ECWU1183 C9 | 4.8 | 3.3 | 1.4 | E1 | ECWU2183KC9 | 4.8 | 3.3 | 2.0 | E2 | | |
| 0.022 | ECWU1223 C9 | 4.8 | 3.3 | 1.4 | E1 | ECWU2223KC9 | 4.8 | 3.3 | 2.0 | E2 | | |
| 0.027 | ECWU1273 C9 | 4.8 | 3.3 | 1.4 | E1 | ECWU2273KC9 | 4.8 | 3.3 | 2.4 | E3a | | |
| 0.033 | ECWU1333 C9 | 4.8 | 3.3 | 1.4 | E1 | ECWU2333KC9 | 4.8 | 3.3 | 2.8 | E3 | | |
| 0.039 | ECWU1393 C9 | 4.8 | 3.3 | 1.4 | E1 | ECWU2393KC9 | 6.0 | 4.1 | 2.0 | D2 | | |
| 0.047 | ECWU1473 C9 | 4.8 | 3.3 | 2.0 | E2 | ECWU2473KC9 | 6.0 | 4.1 | 2.4 | D3 | | |
| 0.056 | ECWU1563 C9 | 4.8 | 3.3 | 2.0 | E2 | ECWU2563KC9 | 6.0 | 4.1 | 2.8 | D4 | | |
| 0.068 | ECWU1683 C9 | 4.8 | 3.3 | 2.4 | E3a | ECWU2683KC9 | 6.0 | 4.1 | 3.2 | D5 | | |
| 0.082 | ECWU1823 C9 | 4.8 | 3.3 | 2.8 | E3 | ECWU2823KC9 | 6.0 | 5.0 | 3.2 | B | | |
| 0.1 | ECWU1104 C9 | 6.0 | 4.1 | 1.8 | D1 | ECWU2104KC9 | 6.0 | 5.0 | 3.8 | B | | |
| 0.12 | ECWU1124 C9 | 6.0 | 4.1 | 2.4 | D3 | ECWU2124KCV | 7.1 | 6.3 | 2.8 | Y | | |
| 0.15 | ECWU1154 C9 | 6.0 | 4.1 | 2.8 | D4 | ECWU2154KCV | 7.1 | 6.3 | 3.5 | Y | | |
| 0.18 | ECWU1184KC9 | 7.1 | 5.0 | 2.0 | Z | ECWU2184KCV | 7.1 | 6.3 | 4.1 | Y | | |
| 0.22 | ECWU1224KC9 | 7.1 | 5.0 | 2.4 | Z | ECWU2224KCV | 7.1 | 6.3 | 5.1 | Y | | |
| 0.27 | ECWU1274KC9 | 7.1 | 5.0 | 2.9 | Z | ECWU2274KCV | 9.8 | 6.3 | 3.9 | V | | |
| 0.33 | ECWU1334KC9 | 7.1 | 5.0 | 3.5 | Z | ECWU2334KCV | 9.8 | 6.3 | 4.8 | V | | |
| 0.39 | ECWU1394KCV | 7.7 | 5.5 | 3.4 | X | ECWU2394KCV | 9.8 | 8.0 | 4.4 | U | | |
| 0.47 | ECWU1474KCV | 7.7 | 5.5 | 4.0 | X | ECWU2474KCV | 9.8 | 8.0 | 5.3 | U | | |
| 0.56 | ECWU1564KCV | 9.8 | 6.3 | 3.0 | V | ECWU2564KCZ | 15.2 | 8.0 | 3.7 | T | | |
| 0.68 | ECWU1684KCV | 9.8 | 6.3 | 3.6 | V | ECWU2684KCZ | 15.2 | 8.0 | 4.4 | T | | |
| 0.82 | ECWU1824KCV | 9.8 | 6.3 | 4.3 | V | ECWU2824KCZ | 15.2 | 10.0 | 4.2 | S | | |
| 1.0 | ECWU1105KCV | 9.8 | 6.3 | 5.1 | V | ECWU2105KCZ | 15.2 | 10.0 | 5.1 | S | | |

Capacitance tolerance code

* Please consult us for capacitance tolerance ± 5%(J).

ECWU (C) Type DC100V series (Stacked Metallized Film)

Electrical Characteristics < Typical Data >

Temperature Characteristics

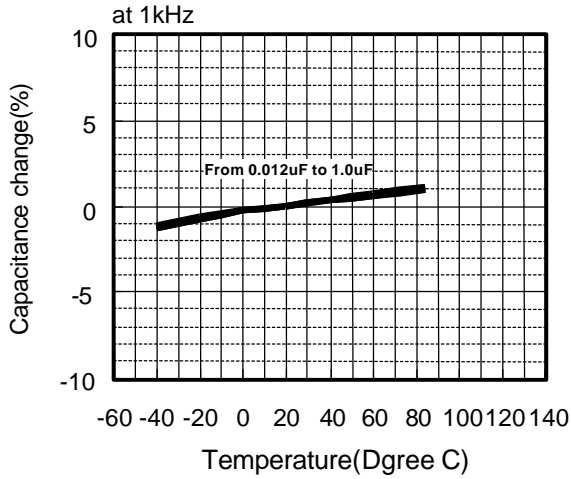

Frequency Characteristics

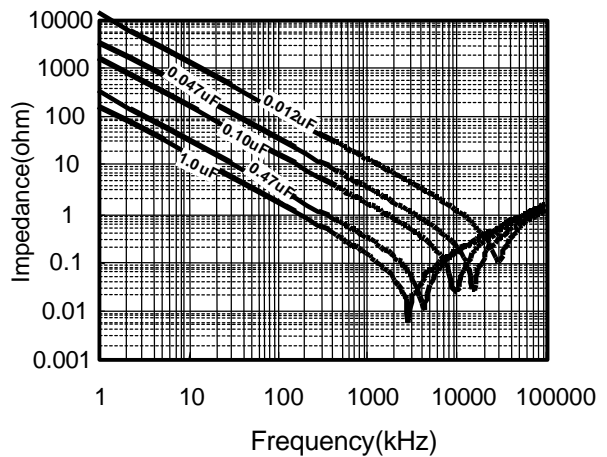
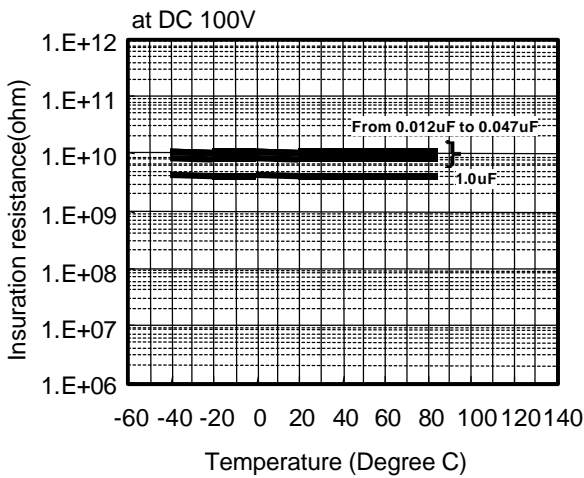
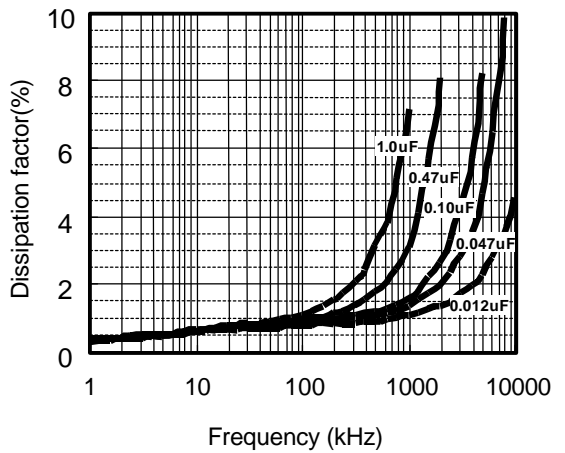
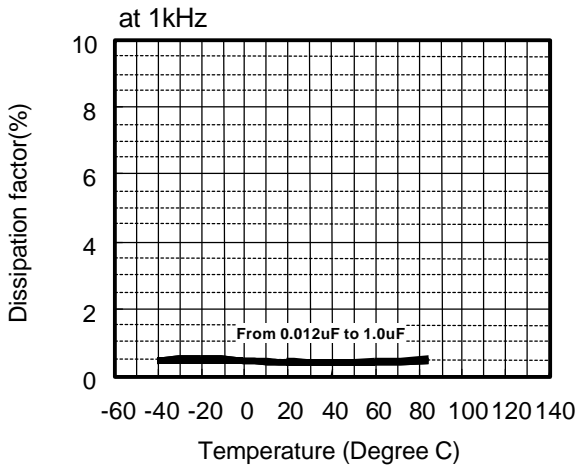
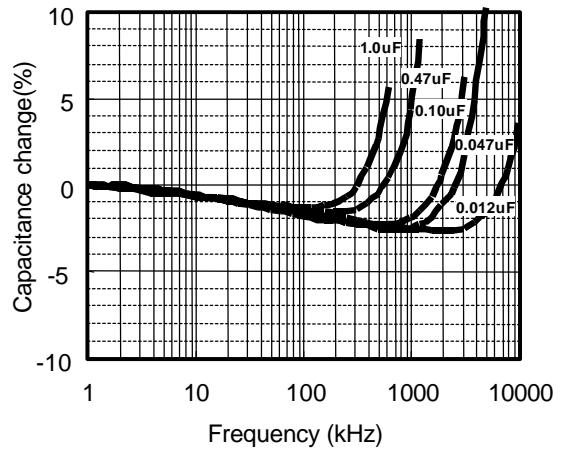

ECWU (C) Type DC100V series (Stacked Metallized Film)

Applicable Specifications

Permissible current

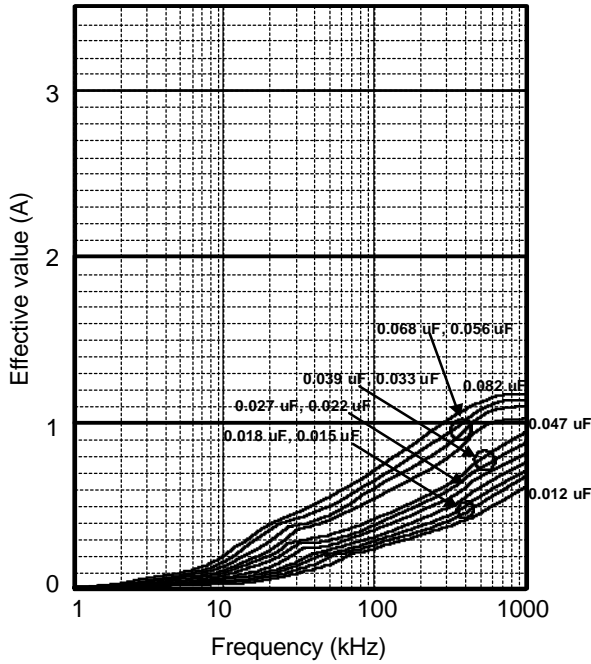

Permissible current

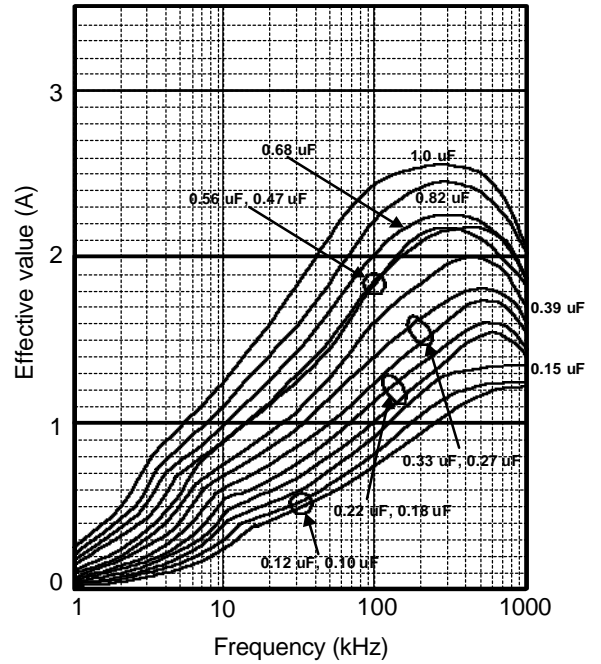

Permissible voltage (at sine wave)

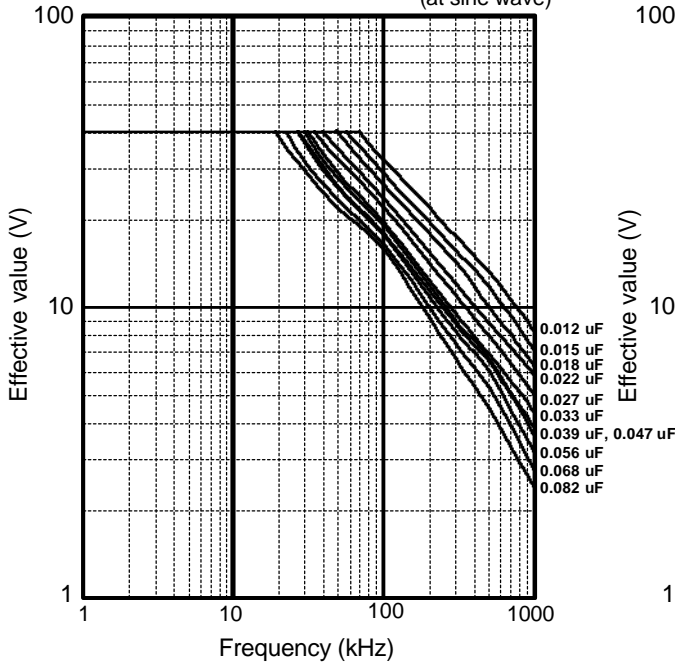

Permissible voltage (at sine wave)

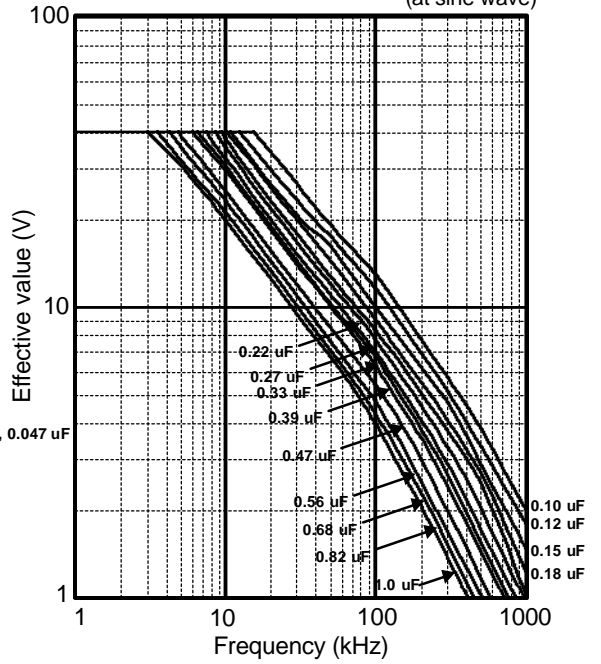

* Please consult Panasonic if your condition exceeds the above spec.

*Permissible voltage graph is the case of sine waveform. When you use this product, peak voltage must not exceed DC rated voltage.

*The current value (Aop) is calculated using "nominal capacitance." In fact, it changes by the tolerance of a capacitance value, capacitance change, etc.



ECWU (C) Type DC100V series (Stacked Metallized Film)

Applicable Specifications

Pulse Handling Capability (dv/dt)
(Max 10000cycles)

| Rating Voltage | Capacitance Value(uF) | Code | dv/dt(V/us) | Current _(o,p) (A) |
|----------------|-----------------------|------|-------------|------------------------------|
| DC 100V | 0.012 | 123 | 320 | 3.8 |
| | 0.015 | 123 | | 4.8 |
| | 0.018 | 183 | | 5.8 |
| | 0.022 | 223 | | 7.0 |
| | 0.027 | 273 | | 8.6 |
| | 0.033 | 333 | | 10.6 |
| | 0.039 | 393 | | 12.5 |
| | 0.047 | 473 | | 15.0 |
| | 0.056 | 563 | | 17.9 |
| | 0.68 | 683 | | 21.8 |
| | 0.82 | 823 | | 26.2 |

Pulse Handling Capability (dv/dt)
(Max 10000cycles)

| Rating Voltage | Capacitance Value(uF) | Code | dv/dt(V/us) | Current _(o,p) (A) |
|----------------|-----------------------|------|-------------|------------------------------|
| DC 100V | 0.10 | 104 | 210 | 21.0 |
| | 0.12 | 124 | | 25.2 |
| | 0.15 | 154 | | 31.5 |
| | 0.18 | 184 | 120 | 21.6 |
| | 0.22 | 224 | | 26.4 |
| | 0.27 | 274 | | 32.4 |
| | 0.33 | 334 | | 39.6 |
| | 0.39 | 394 | 100 | 39.0 |
| | 0.47 | 474 | | 47.0 |
| | 0.56 | 564 | 70 | 39.2 |
| | 0.68 | 684 | | 47.6 |
| | 0.82 | 824 | | 57.4 |
| | 1.0 | 105 | | 70.0 |

Voltage Derating by Temperature

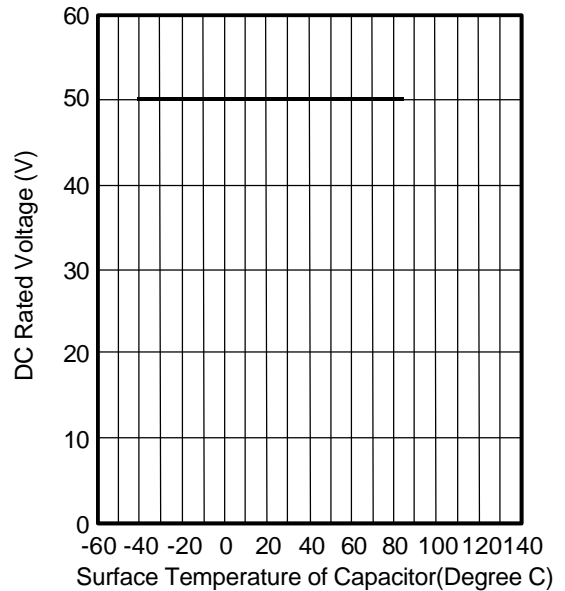

* Please consult Panasonic if your condition exceeds the above spec.

*Permissible voltage graph is the case of sine waveform. When you use this product, peak voltage must not exceed DC rated voltage.

*The current_(o,p) value is calculated using nominal capacitance.

ECWU (C) Type DC16V series (Stacked Metallized Film)

Electrical Characteristics < Typical Data >

Temperature Characteristics

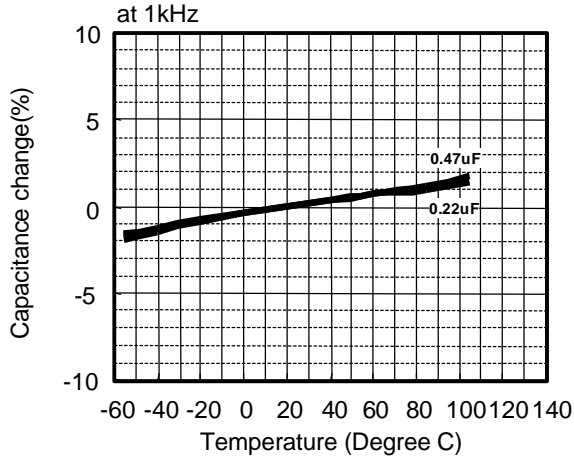

Frequency Characteristics

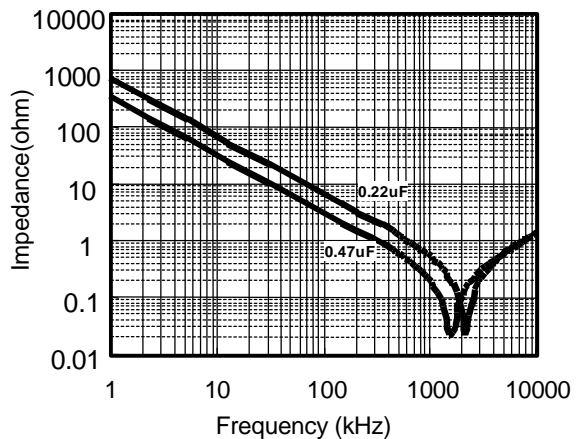
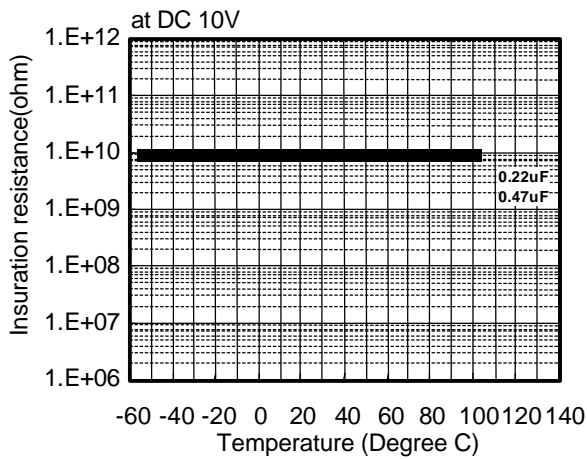
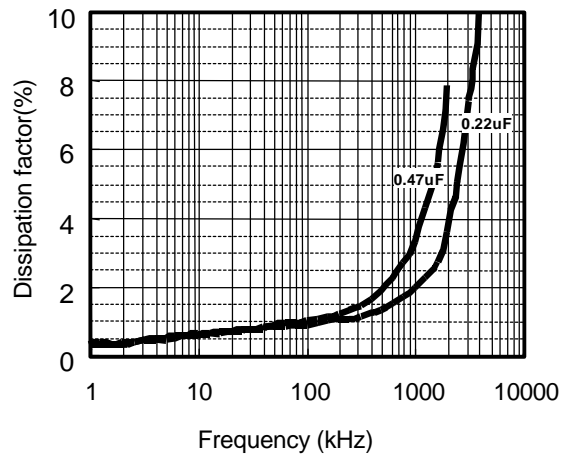
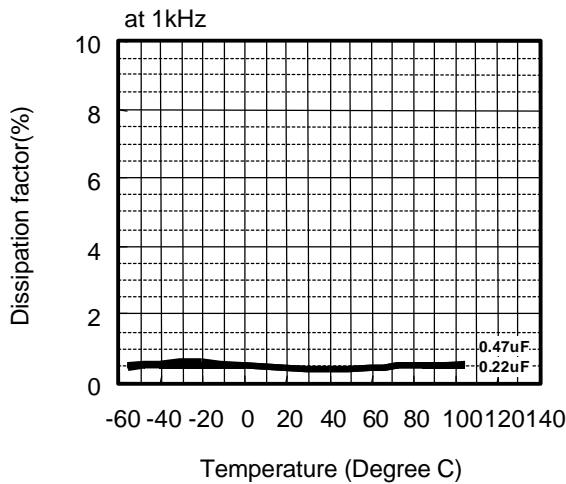
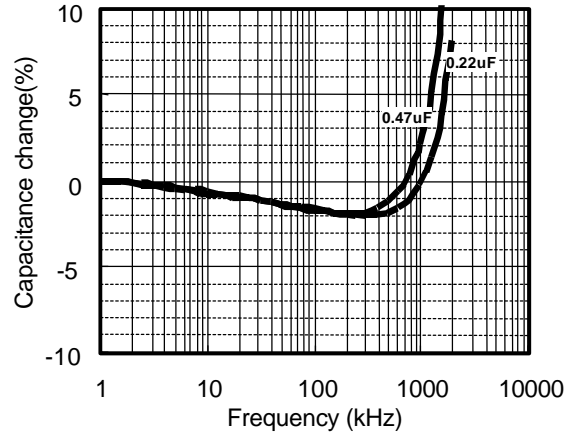

ECWU (C) Type DC16V series (Stacked Metallized Film)

Applicable Specifications

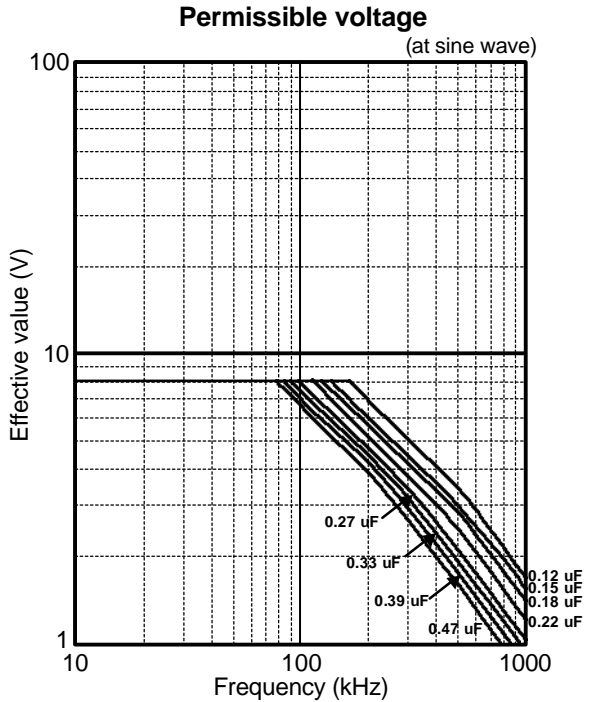
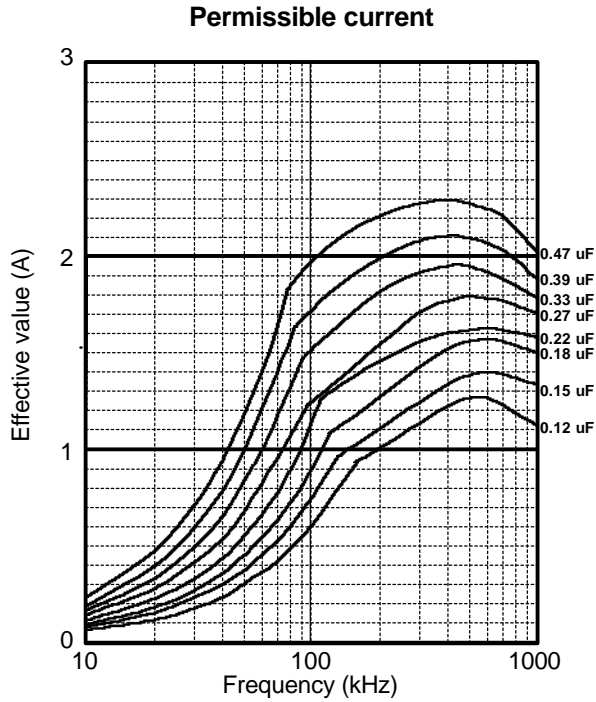

**Pulse Handling Capability (dv/dt)
(Max 10000cycles)**

| Rating Voltage | Capacitance Value(uF) | Code | dv/dt(V/us) | Current _(o,p) (A) |
|----------------|-----------------------|------|-------------|------------------------------|
| DC 16V | 0.12 | 124 | 60 | 7.2 |
| | 0.15 | 154 | | 9.0 |
| | 0.18 | 184 | | 10.8 |
| | 0.22 | 224 | | 13.2 |
| | 0.27 | 274 | 40 | 10.8 |
| | 0.33 | 334 | | 13.2 |
| | 0.39 | 394 | | 15.6 |
| | 0.47 | 474 | | 18.8 |

Voltage Derating by Temperature

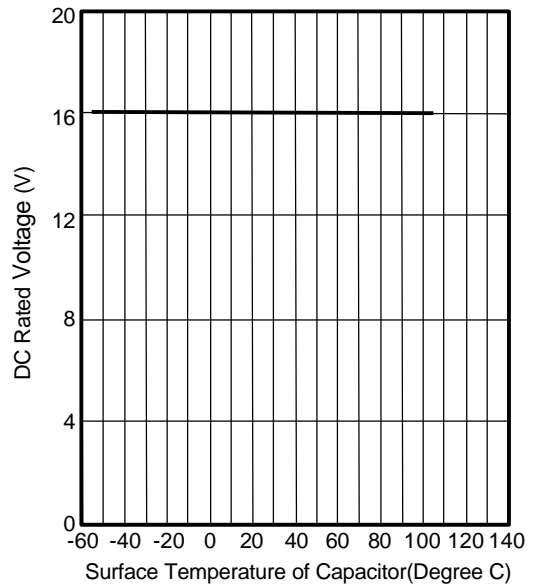

* Please consult Panasonic if your condition exceeds the above spec.
 *Permissible voltage graph is the case of sine waveform. When you use this product, peak voltage must not exceed DC rated voltage.
 *The current_(o,p) value is calculated using nominal capacitance.

ECWU (C) Type DC50V series (Stacked Metallized Film)

Electrical Characteristics < Typical Data >

Temperature Characteristics

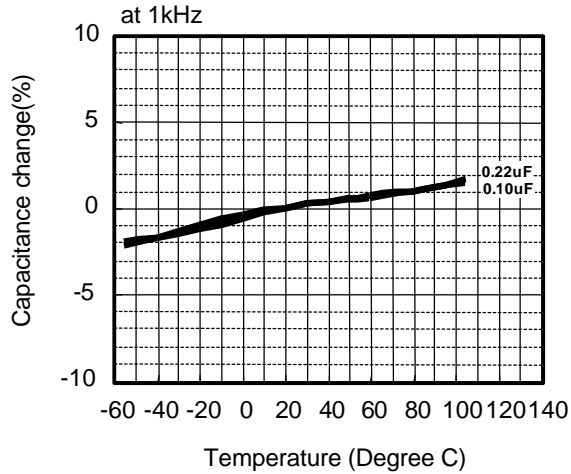

Frequency Characteristics

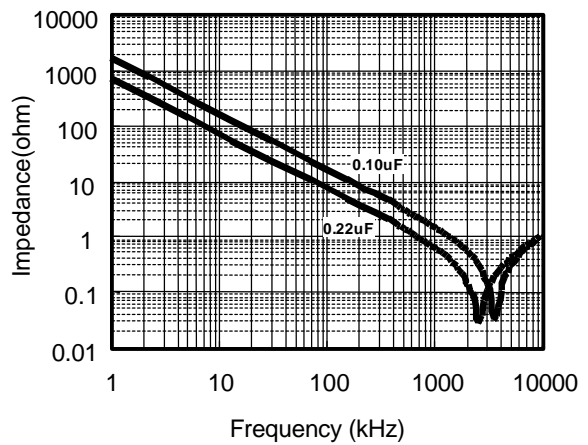
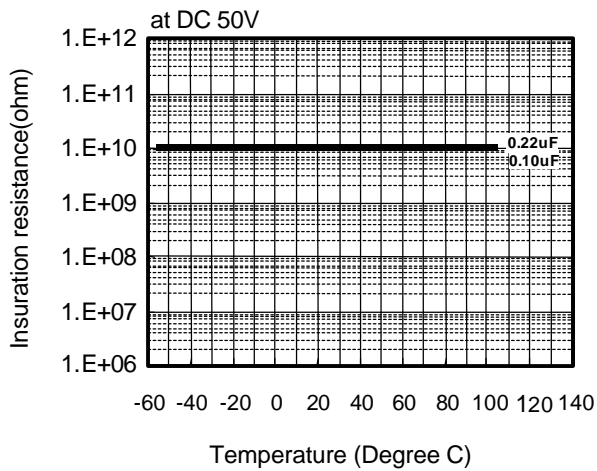
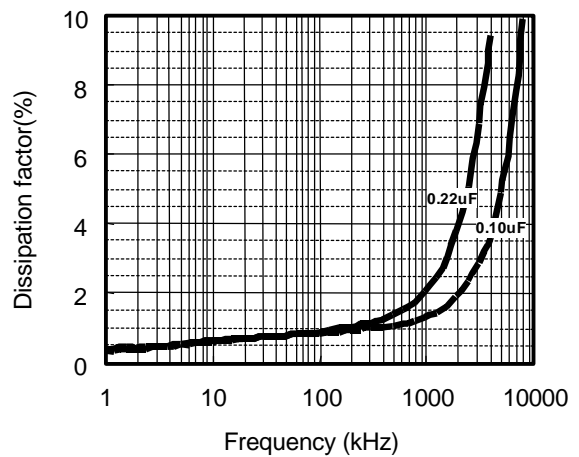
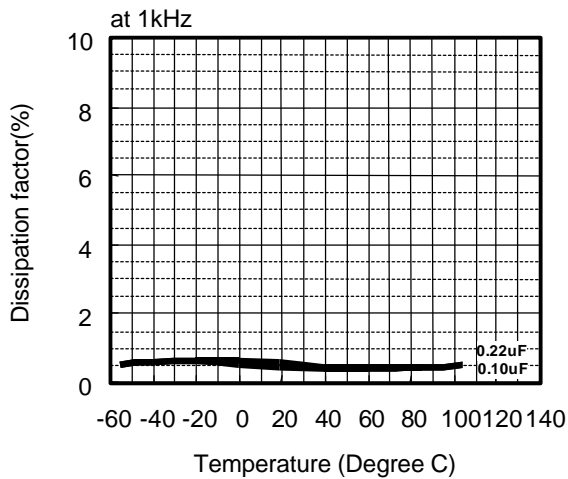
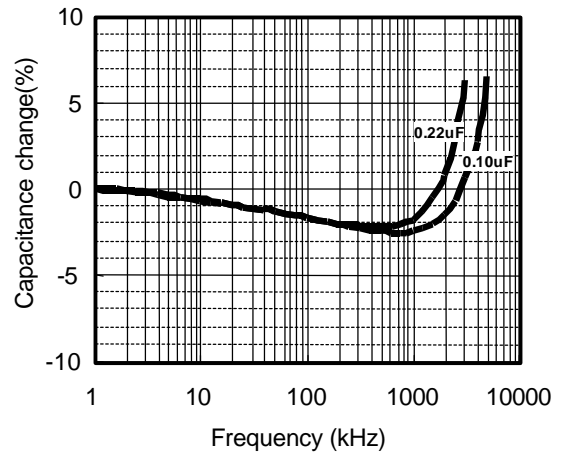



ECWU (C) Type DC50V series (Stacked Metallized Film)

Applicable Specifications

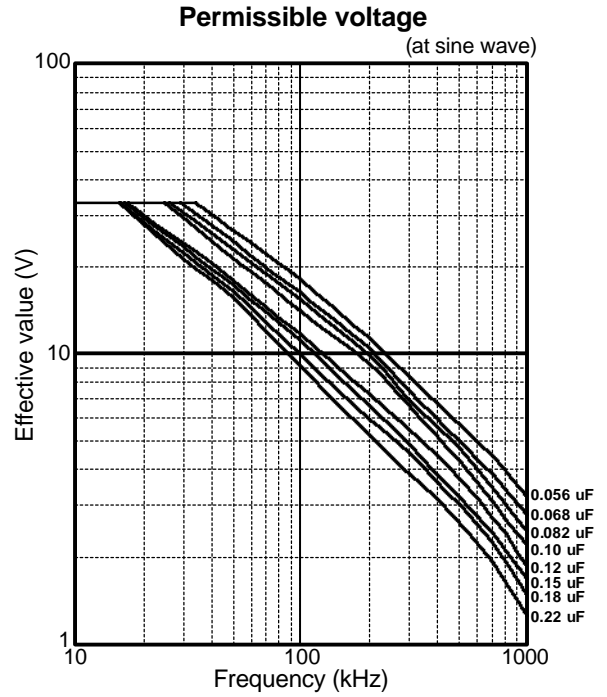
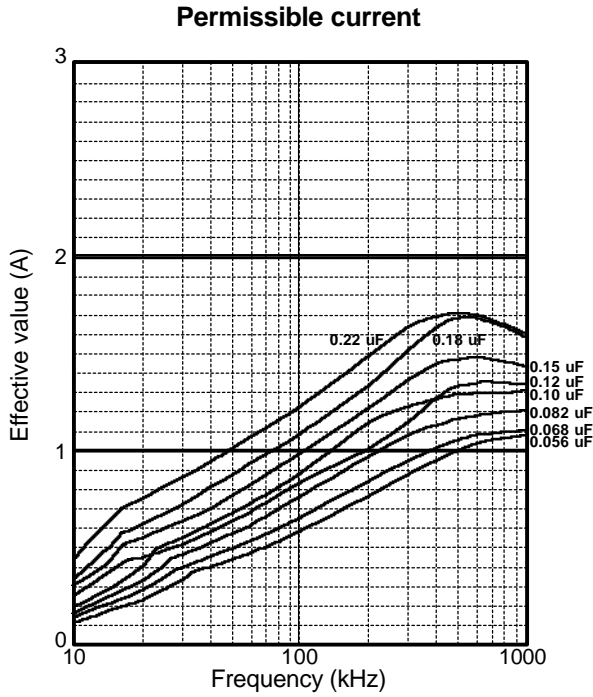

**Pulse Handling Capability (dv/dt)
(Max 10000cycles)**

| Rating Voltage | Capacitance Value(uF) | Code | dv/dt(V/us) | Current _(o,p) (A) |
|----------------|-----------------------|------|-------------|------------------------------|
| DC 50V | 0.056 | 563 | 190 | 10.6 |
| | 0.068 | 683 | | 12.9 |
| | 0.082 | 823 | | 15.6 |
| | 0.10 | 104 | | 19.0 |
| | 0.12 | 124 | 130 | 15.6 |
| | 0.15 | 154 | | 19.5 |
| | 0.18 | 184 | | 23.4 |
| | 0.22 | 224 | | 28.6 |

Voltage Derating by Temperature

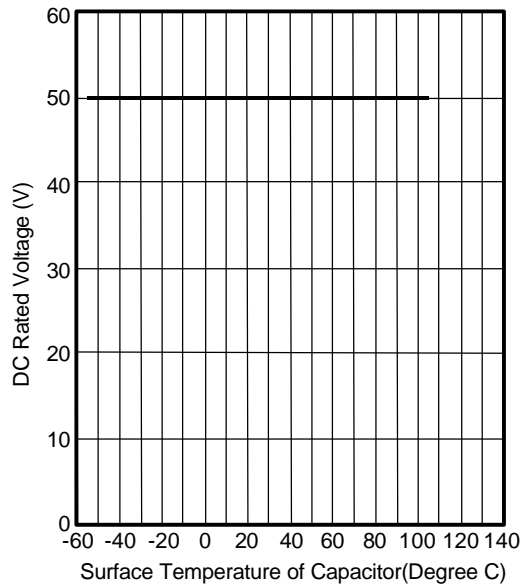

* Please consult Panasonic if your condition exceeds the above spec.

*Permissible voltage graph is the case of sine waveform. When you use this product, peak voltage must not exceed DC rated voltage.

*The current_(o,p) value is calculated using nominal capacitance.

ECWU (C) Type DC250V series (Stacked Metallized Film)

Electrical Characteristics < Typical Data >

Temperature Characteristics

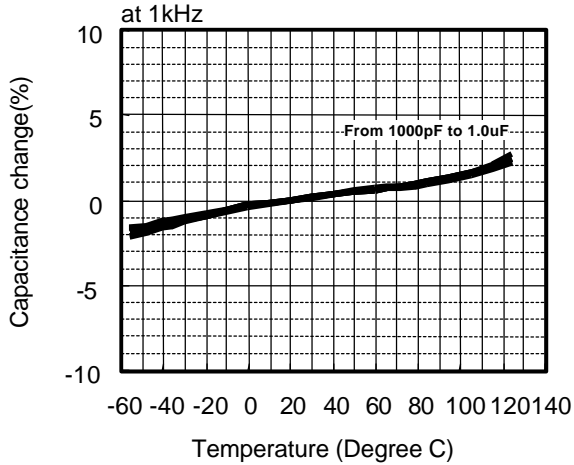

Frequency Characteristics

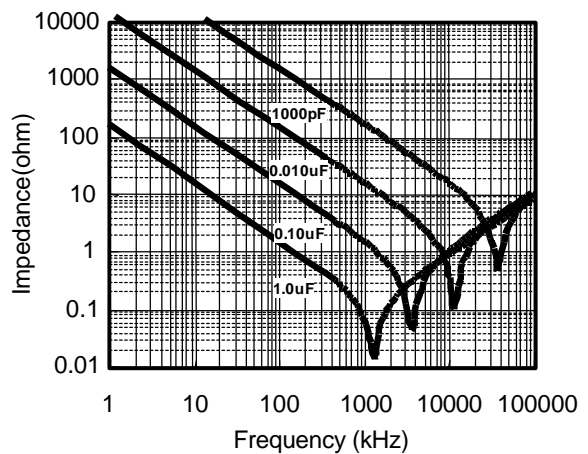
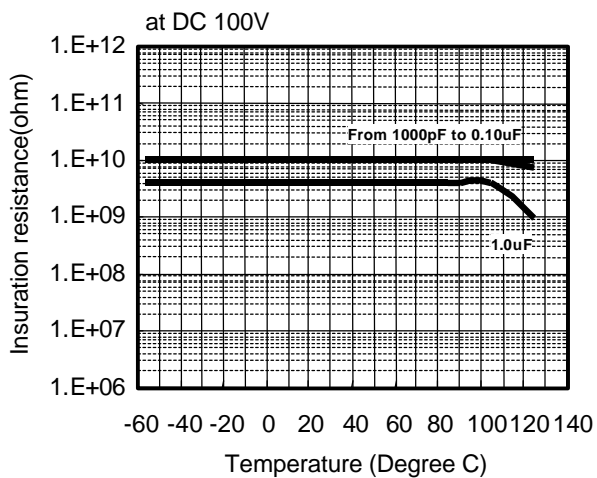
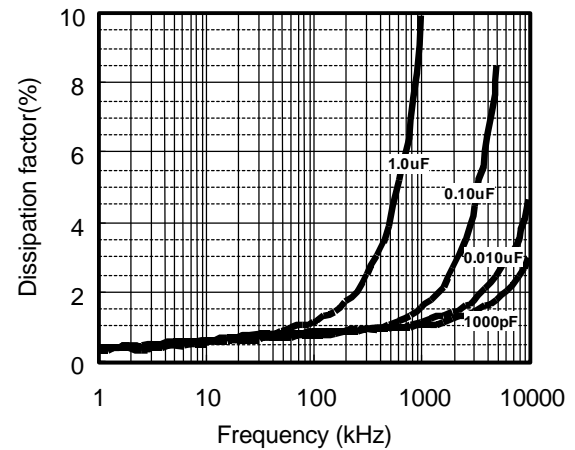
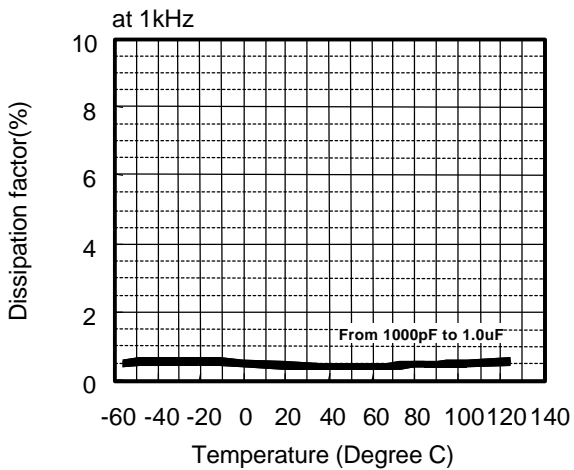
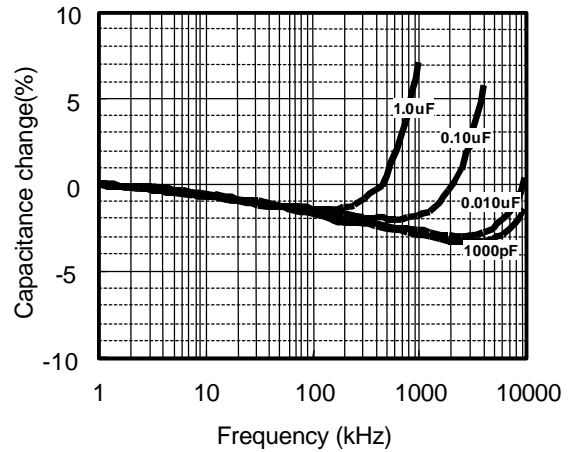

ECWU (C) Type DC250V series (Stacked Metallized Film)

Applicable Specifications

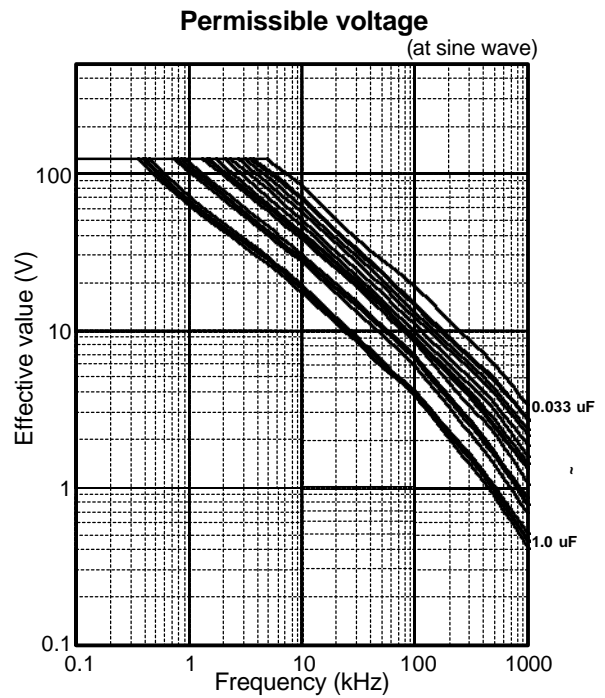
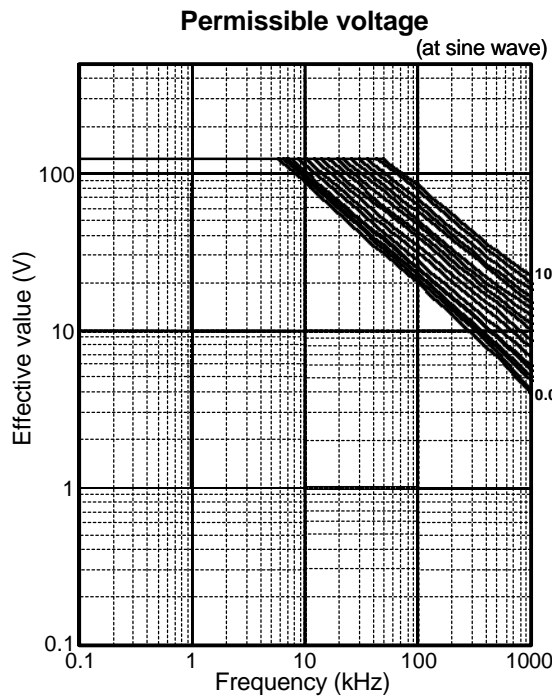
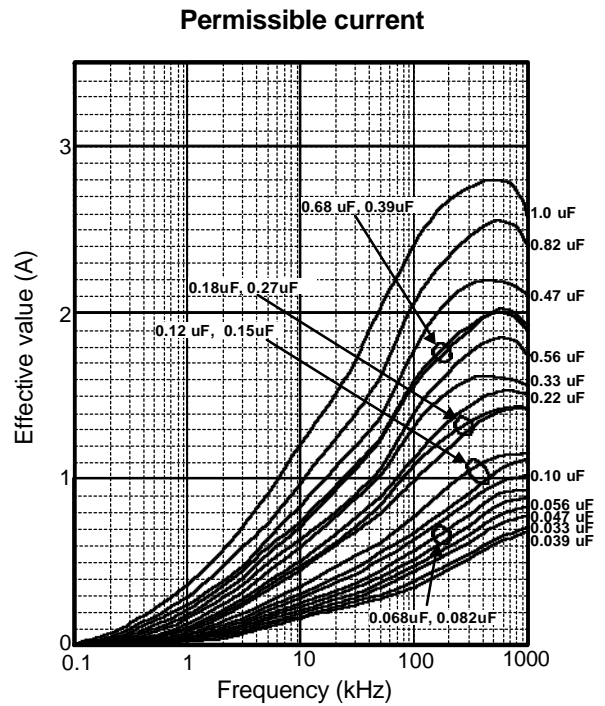
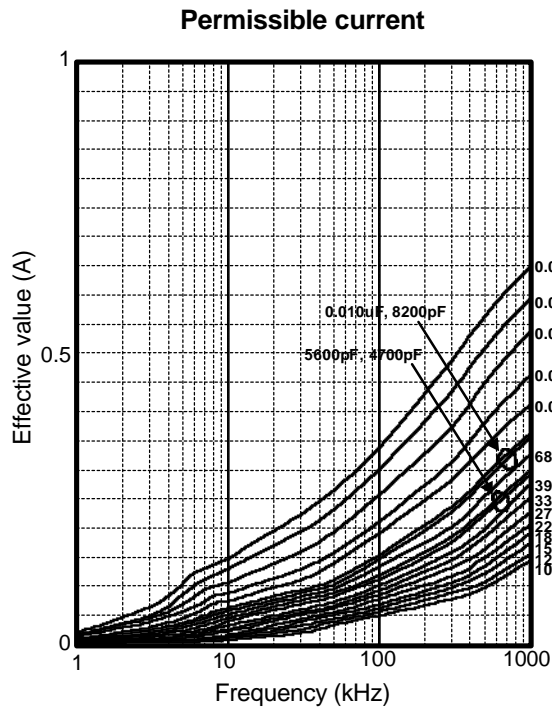

* Please consult Panasonic if your condition exceeds the above spec.

*Permissible voltage graph is the case of sine waveform. When you use this product, peak voltage must not exceed DC rated voltage.

*The current_(0-P) value is calculated using nominal capacitance.



ECWU (C) Type DC250V series (Stacked Metallized Film)

Applicable Specifications

Pulse Handling Capability (dv/dt) (Max 10000cycles)

| Rating Voltage | Capacitance Value(uF) | Code | dv/dt(V/us) | Current _(o,p) (A) |
|----------------|-----------------------|------|-------------|------------------------------|
| DC 250V | 0.0010 | 102 | 615 | 0.62 |
| | 0.0012 | 122 | | 0.74 |
| | 0.0015 | 152 | | 0.92 |
| | 0.0018 | 182 | | 1.11 |
| | 0.0022 | 222 | | 1.35 |
| | 0.0027 | 272 | | 1.66 |
| | 0.0033 | 332 | | 2.03 |
| | 0.0039 | 392 | | 2.40 |
| | 0.0047 | 472 | 360 | 1.69 |
| | 0.0056 | 562 | | 2.02 |
| | 0.0068 | 682 | | 2.45 |
| | 0.0082 | 822 | | 2.95 |
| | 0.010 | 103 | | 3.60 |
| | 0.012 | 123 | | 4.32 |
| | 0.015 | 153 | | 5.40 |
| | 0.018 | 183 | | 6.48 |
| | 0.022 | 223 | | 7.92 |
| | 0.027 | 273 | | 9.72 |
| | 0.033 | 333 | | 11.88 |

| Rating Voltage | Capacitance Value(uF) | Code | dv/dt(V/us) | Current _(o,p) (A) |
|----------------|-----------------------|------|-------------|------------------------------|
| DC 250V | 0.039 | 393 | 240 | 9.36 |
| | 0.047 | 473 | | 11.28 |
| | 0.056 | 563 | | 13.44 |
| | 0.068 | 683 | | 16.32 |
| | 0.082 | 823 | | 19.68 |
| | 0.10 | 104 | | 24.00 |
| | 0.12 | 124 | | 28.80 |
| | 0.15 | 154 | | 190 |
| | 0.18 | 184 | 34.20 | |
| | 0.22 | 224 | 41.80 | |
| | 0.27 | 274 | 115 | |
| | 0.33 | 334 | | 37.95 |
| | 0.39 | 394 | | 44.85 |
| | 0.47 | 474 | | 54.05 |
| | 0.56 | 564 | 65 | 36.40 |
| | 0.68 | 684 | | 44.20 |
| | 0.82 | 824 | | 53.30 |
| | 1.0 | 105 | | 65.00 |

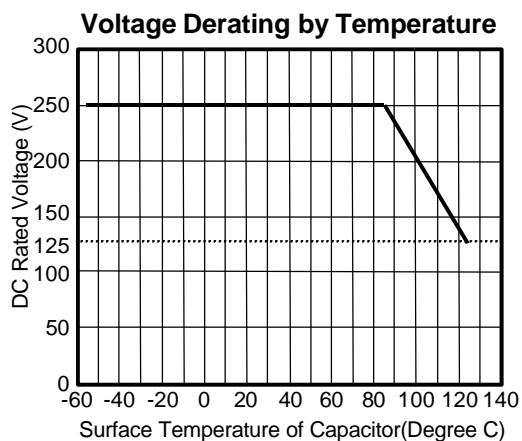

* Please consult Panasonic if your condition exceeds the above spec.

*Permissible voltage graph is the case of sine waveform. When you use this product, peak voltage must not exceed DC rated voltage.

*The current_(o,p) value is calculated using nominal capacitance.