

## 125MHz Single Supply Dual/Quad Op Amps

The EL2250/EL2450 are part of a family of the electronics industries fastest single supply op amps available. Prior single supply op amps have generally been limited to bandwidths and slew rates to that of the EL2250/EL2450. The 125MHz bandwidth, 275V/ $\mu$ s slew rate, and 0.05%/0.05° differential gain/differential phase makes this part ideal for single or dual supply video speed applications. With its voltage feedback architecture, this amplifier can accept reactive feedback networks, allowing them to be used in analog filtering applications. The inputs can sense signals below the bottom supply rail and as high as 1.2V below the top rail. Connecting the load resistor to ground and operating from a single supply, the outputs swing completely to ground without saturating. The outputs can also drive to within 1.2V of the top rail. The EL2250/EL2450 will output  $\pm$ 100mA and will operate with single supply voltages as low as 2.7V, making them ideal for portable, low power applications.

The EL2250/EL2450 are available in PDIP and SO packages in industry standard pin outs. Both parts operate over the industrial temperature range of -40°C to +85°C, and are part of a family of single supply op amps. For single amplifier applications, see the EL2150/EL2157. For dual and triple amplifiers with power down and output voltage clamps, see the EL2257/EL2357.

## Ordering Information

PART NUMBER	PART MARKING	TAPE & REEL	PACKAGE	PKG. DWG. #
EL2250CN	EL2250CN	-	8 Ld PDIP	MDP0031
EL2250CS	2250CS	-	8 Ld SO	MDP0027
EL2250CS-T7	2250CS	7"	8 Ld SO	MDP0027
EL2250CS-T13	2250CS	13"	8 Ld SO	MDP0027
EL2250CSZ (Note)	2250CSZ	-	8 Ld SO (Pb-free)	MDP0027
EL2250CSZ-T7 (Note)	2250CSZ	7"	8 Ld SO (Pb-free)	MDP0027
EL2250CSZ-T13 (Note)	2250CSZ	13"	8 Ld SO (Pb-free)	MDP0027
EL2450CN	EL2450CN	-	14 Ld PDIP	MDP0031
EL2450CS	2450CS	-	14 Ld SO	MDP0027
EL2450CS-T7	2450CS	7"	14 Ld SO	MDP0027
EL2450CS-T13	2450CS	13"	14 Ld SO	MDP0027

NOTE: Intersil Pb-free plus anneal products employ special Pb-free material sets; molding compounds/die attach materials and 100% matte tin plate termination finish, which are RoHS compliant and compatible with both SnPb and Pb-free soldering operations. Intersil Pb-free products are MSL classified at Pb-free peak reflow temperatures that meet or exceed the Pb-free requirements of IPC/JEDEC J STD-020.

## Features

- Specified for +3V, +5V, or  $\pm$ 5V applications
- Large input common mode range  
 $0V < V_{CM} < V_S - 1.2V$
- Output swings to ground without saturating
- -3dB bandwidth = 125MHz
- $\pm$ 0.1dB bandwidth = 30MHz
- Low supply current = 5mA (per amplifier)
- Slew rate = 275V/ $\mu$ s
- Low offset voltage = 4mV max
- Output current =  $\pm$ 100mA
- High open loop gain = 80dB
- Differential gain = 0.05%
- Differential phase = 0.05°
- Pb-free plus anneal available (RoHS compliant)

## Applications

- Video amplifiers
- PCMCIA applications
- A/D drivers
- Line drivers
- Portable computers
- High speed communications
- RGB printers, FAX, scanners
- Broadcast equipment
- Active filtering

Pinouts

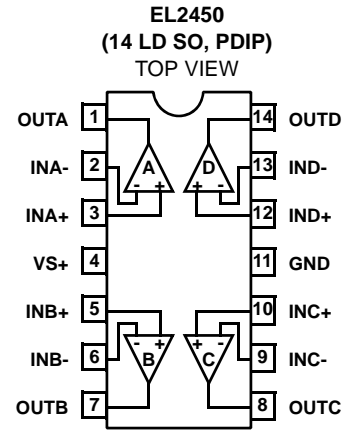
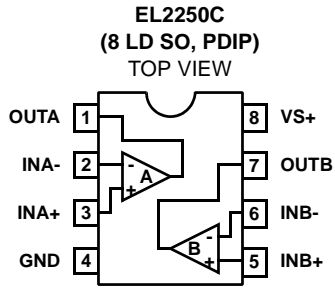

## EL2250, EL2450

### Absolute Maximum Ratings (T<sub>A</sub> = 25°C)

Supply Voltage between V <sub>S</sub> and GND . . . . . +12.6V	Power Dissipation . . . . . See Curves
Input Voltage (IN+, IN-) . . . . . GND-0.3V, V <sub>S</sub> +0.3V	Storage Temperature Range . . . . . -65°C to +150°C
Differential Input Voltage . . . . . ±6V	Ambient Operating Temperature Range . . . . . -40°C to +85°C
Maximum Output Current . . . . . 90mA	Operating Junction Temperature . . . . . 150°C
Output Short Circuit Duration . . . . . (Note 1)	

*CAUTION: Stresses above those listed in "Absolute Maximum Ratings" may cause permanent damage to the device. This is a stress only rating and operation of the device at these or any other conditions above those indicated in the operational sections of this specification is not implied.*

*IMPORTANT NOTE: All parameters having Min/Max specifications are guaranteed. Typical values are for information purposes only. Unless otherwise noted, all tests are at the specified temperature and are pulsed tests, therefore: T<sub>J</sub> = T<sub>C</sub> = T<sub>A</sub>*

### DC Electrical Specifications V<sub>S</sub> = +5V, GND = 0V, T<sub>A</sub> = 25°C, V<sub>CM</sub> = 1.5V, V<sub>OUT</sub> = 1.5V, unless otherwise specified.

PARAMETER	DESCRIPTION	TEST CONDITIONS	MIN	TYP	MAX	UNIT
V <sub>OS</sub>	Offset Voltage		-12		12	mV
TCV <sub>OS</sub>	Offset Voltage Temperature Coefficient	Measured from T <sub>MIN</sub> to T <sub>MAX</sub>		10		μV/°C
I <sub>B</sub>	Input Bias Current	V <sub>IN</sub> = 0V		-5.5	-10	μA
I <sub>OS</sub>	Input Offset Current	V <sub>IN</sub> = 0V	-1200	150	1200	nA
TCI <sub>OS</sub>	Input Bias Current Temperature Coefficient	Measured from T <sub>MIN</sub> to T <sub>MAX</sub>		50		nA/°C
PSRR	Power Supply Rejection Ratio	V <sub>S</sub> = +2.7V to +12V	55	70		dB
CMRR	Common Mode Rejection Ratio	V <sub>CM</sub> = 0V to +3.8V	45	65		dB
		V <sub>CM</sub> = 0V to +3.0V	50	70		dB
CMIR	Common Mode Input Range		0		V <sub>S</sub> -1.2	V
R <sub>IN</sub>	Input Resistance	Common Mode	1	2		MΩ
C <sub>IN</sub>	Input Capacitance	SO Package		1		pF
		PDIP Package		1.5		pF
R <sub>OUT</sub>	Output Resistance	A <sub>V</sub> = +1		40		mΩ
I <sub>S</sub>	Supply Current (per amplifier)	V <sub>S</sub> = +12V		5	6.5	mA
PSOR	Power Supply Operating Range		2.7		12.0	V

### DC Electrical Specifications V<sub>S</sub> = +5V, GND = 0V, T<sub>A</sub> = 25°C, V<sub>CM</sub> = +1.5V, V<sub>OUT</sub> = +1.5V, unless otherwise specified.

PARAMETER	DESCRIPTION	TEST CONDITIONS	MIN	TYP	MAX	UNIT
AVOL	Open Loop Gain	V <sub>S</sub> = +12V, V <sub>OUT</sub> = +2V to +9V, R <sub>L</sub> = 1kΩ to GND	60	80		dB
		V <sub>OUT</sub> = +1.5V to +3.5V, R <sub>L</sub> = 1kΩ to GND		70		dB
		V <sub>OUT</sub> = +1.5V to +3.5V, R <sub>L</sub> = 150Ω to GND		60		dB
V <sub>OP</sub>	Positive Output Voltage Swing	V <sub>S</sub> = +12V, A <sub>V</sub> = +1, R <sub>L</sub> = 1kΩ to 0V		10.8		V
		V <sub>S</sub> = +12V, A <sub>V</sub> = +1, R <sub>L</sub> = 150Ω to 0V	9.6	10.0		V
		V <sub>S</sub> = ±5V, A <sub>V</sub> = +1, R <sub>L</sub> = 1kΩ to 0V		4.0		V
		V <sub>S</sub> = ±5V, A <sub>V</sub> = +1, R <sub>L</sub> = 150Ω to 0V	3.4	3.8		V
		V <sub>S</sub> = +3V, A <sub>V</sub> = +1, R <sub>L</sub> = 150Ω to 0V	1.8	1.95		V
V <sub>ON</sub>	Negative Output Voltage Swing	V <sub>S</sub> = +12V, A <sub>V</sub> = +1, R <sub>L</sub> = 150Ω to 0V		5.5	8	mV
		V <sub>S</sub> = ±5V, A <sub>V</sub> = +1, R <sub>L</sub> = 1kΩ to 0V		-4.0		V
		V <sub>S</sub> = ±5V, A <sub>V</sub> = +1, R <sub>L</sub> = 150Ω to 0V		-3.7	-3.4	V
I <sub>OUT</sub>	Output Current (Note 1)	V <sub>S</sub> = ±5V, A <sub>V</sub> = +1, R <sub>L</sub> = 10Ω to 0V	±75	±100		mA
		V <sub>S</sub> = ±5V, A <sub>V</sub> = +1, R <sub>L</sub> = 50Ω to 0V ±60VmA				

NOTE:

1. Internal short circuit protection circuitry has been built into the EL2250/EL2450; see the Applications section

## EL2250, EL2450

**AC Electrical Specifications**  $V_S = +5V$ ,  $GND = 0V$ ,  $T_A = 25^\circ C$ ,  $V_{CM} = +1.5V$ ,  $V_{OUT} = +1.5V$ ,  $A_V = +1$ ,  $R_F = 0\Omega$ ,  $R_L = 150\Omega$  to GND pin, unless otherwise specified. (Note 1)

PARAMETER	DESCRIPTION	TEST CONDITIONS	MIN	TYP	MAX	UNIT
BW	-3dB Bandwidth ( $V_{OUT} = 400mV_{P-P}$ )	$V_S = +5V$ , $A_V = +1$ , $R_F = 0\Omega$		125		MHz
		$V_S = +5V$ , $A_V = -1$ , $R_F = 500\Omega$		60		MHz
		$V_S = +5V$ , $A_V = +2$ , $R_F = 500\Omega$		60		MHz
		$V_S = +5V$ , $A_V = +10$ , $R_F = 500\Omega$		6		MHz
		$V_S = +12V$ , $A_V = +1$ , $R_F = 0\Omega$		150		MHz
		$V_S = +3V$ , $A_V = +1$ , $R_F = 0\Omega$		100		MHz
BW	$\pm 0.1dB$ Bandwidth ( $V_{OUT} = 400mV_{P-P}$ )	$V_S = +12V$ , $A_V = +1$ , $R_F = 0\Omega$		25		MHz
		$V_S = +5V$ , $A_V = +1$ , $R_F = 0\Omega$		30		MHz
		$V_S = +3V$ , $A_V = +1$ , $R_F = 0\Omega$		20		MHz
GBWP	Gain Bandwidth Product	$V_S = +12V$ , @ $A_V = +10$		60		MHz
PM	Phase Margin	$R_L = 1k\Omega$ , $C_L = 6pF$		55		°
SR	Slew Rate	$V_S = +10V$ , $R_L = 150\Omega$ , $V_{OUT} = 0V$ to $+6V$	200	275		V/ $\mu s$
		$V_S = +5V$ , $R_L = 150\Omega$ , $V_{OUT} = 0V$ to $+3V$		300		V/ $\mu s$
$t_R$ , $t_F$	Rise Time, Fall Time	$\pm 0.1V$ Step		2.8		ns
OS	Overshoot	$\pm 0.1V$ Step		10		%
$t_{PD}$	Propagation Delay	$\pm 0.1V$ Step		3.2		ns
$t_S$	0.1% Settling Time	$V_S = \pm 5V$ , $R_L = 500\Omega$ , $A_V = +1$ , $V_{OUT} = \pm 3V$		40		ns
	0.01% Settling Time	$V_S = \pm 5V$ , $R_L = 500\Omega$ , $A_V = +1$ , $V_{OUT} = \pm 3V$		75		ns
dG	Differential Gain (Note 2)	$A_V = +2$ , $R_F = 1k\Omega$		0.05		%
dP	Differential Phase (Note 2)	$A_V = +2$ , $R_F = 1k\Omega$		0.05		°
$e_N$	Input Noise Voltage	$f = 10kHz$		48		nV/ $\sqrt{Hz}$
$i_N$	Input Noise Current	$f = 10kHz$		1.25		pA/ $\sqrt{Hz}$

**NOTES:**

- All AC tests are performed on a "warmed up" part, except slew rate, which is pulse tested.
- Standard NTSC signal =  $286mV_{P-P}$ ,  $f = 3.58MHz$ , as  $V_{IN}$  is swept from 0.6V to 1.314V;  $R_L$  is DC coupled.

Typical Performance Curves

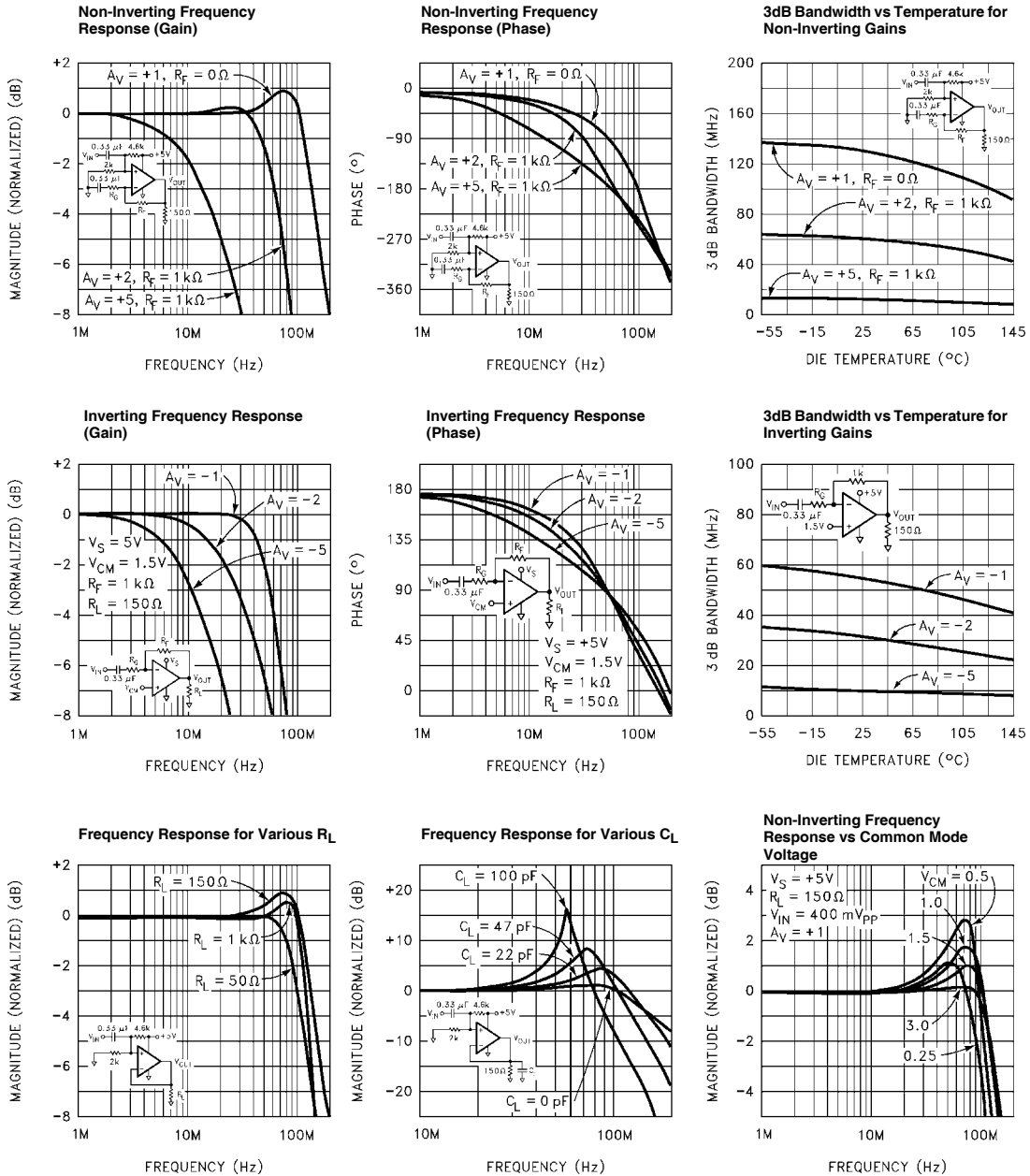

Typical Performance Curves (Continued)

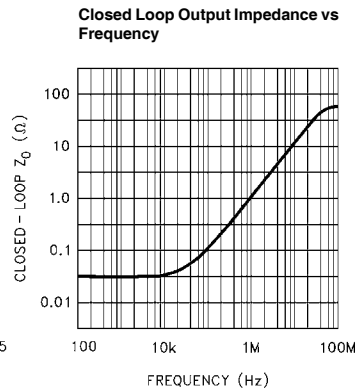
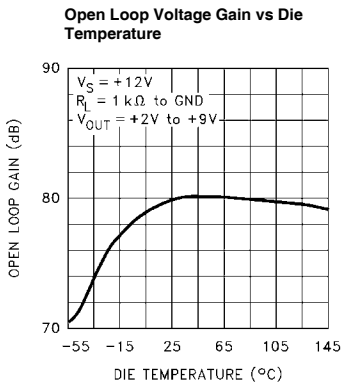
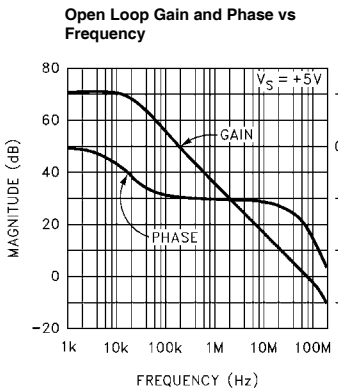
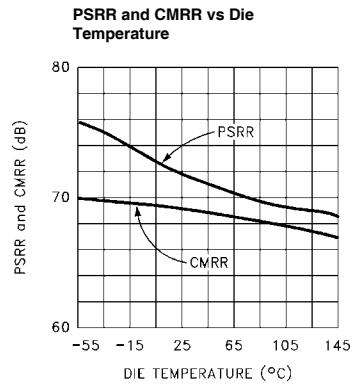
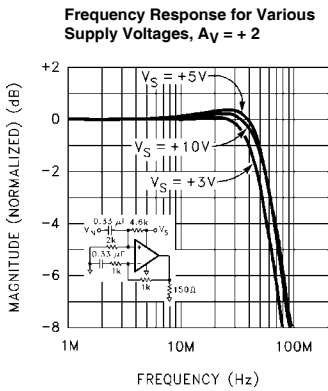
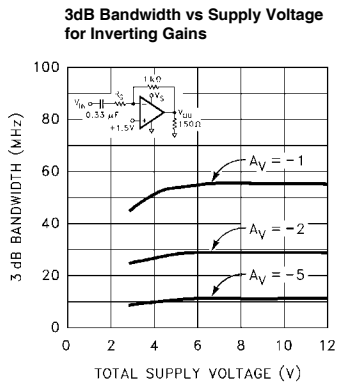
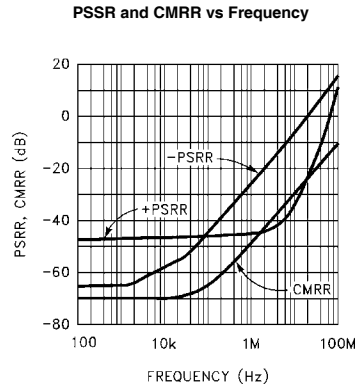
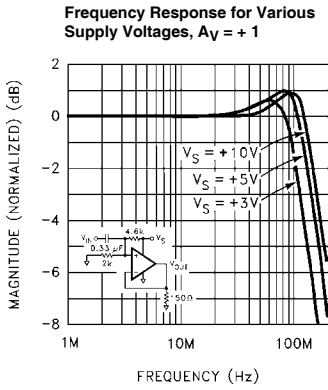
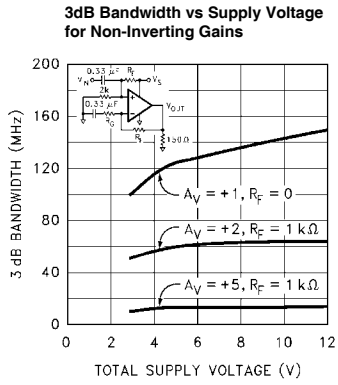

Typical Performance Curves (Continued)

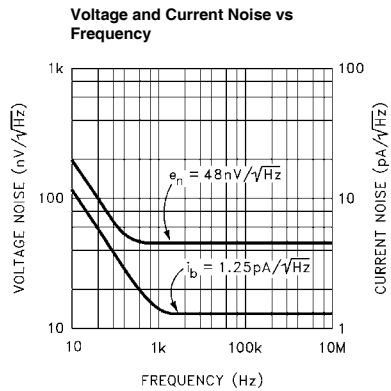
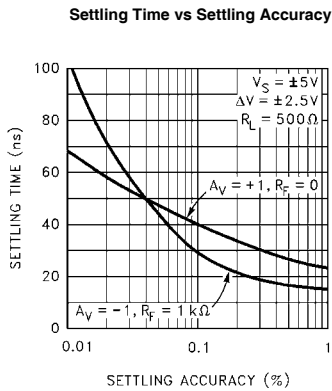
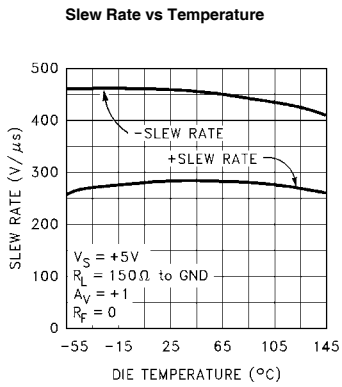
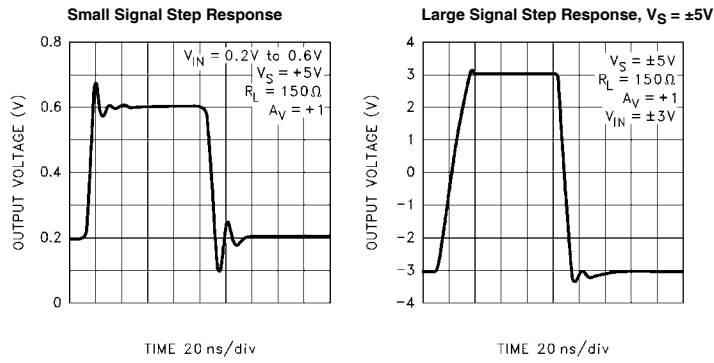
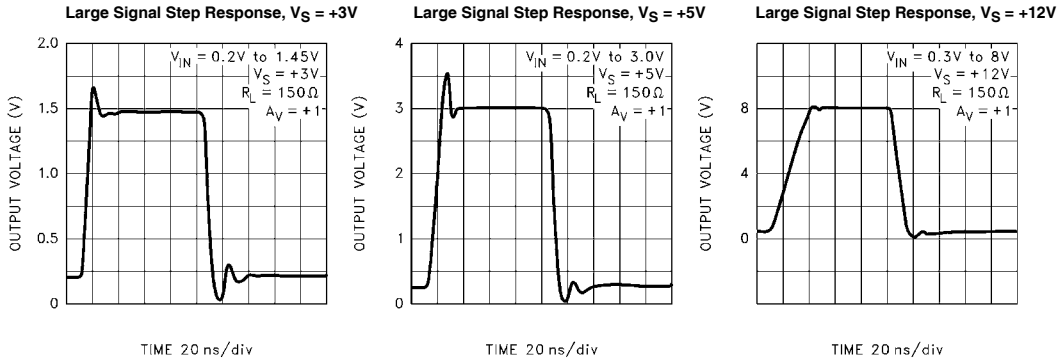

Typical Performance Curves (Continued)

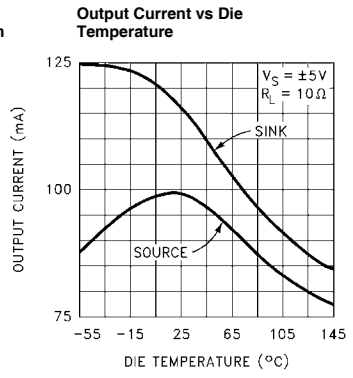
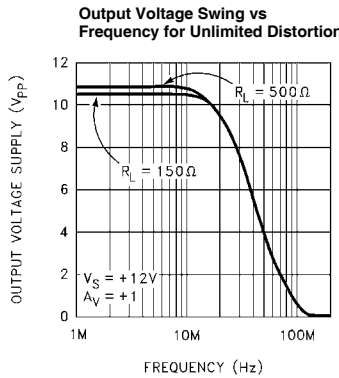
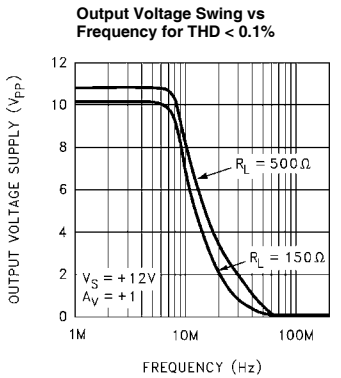
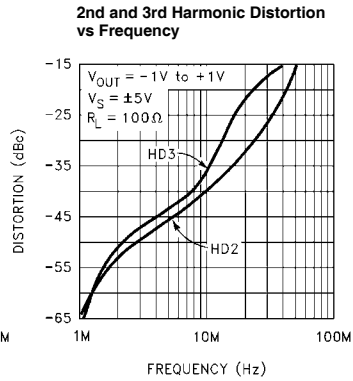
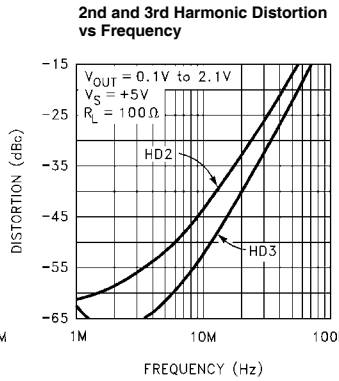
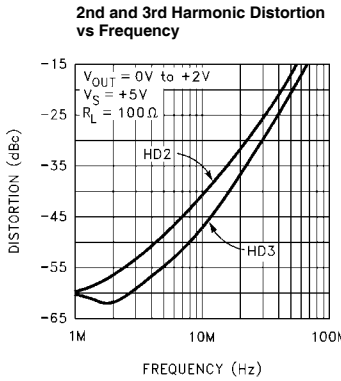
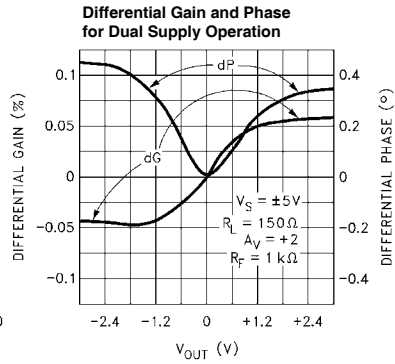
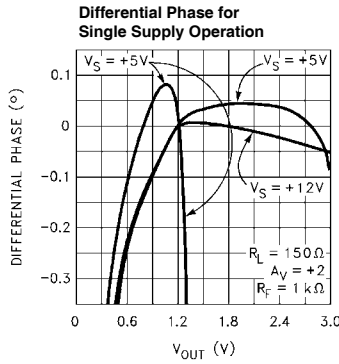
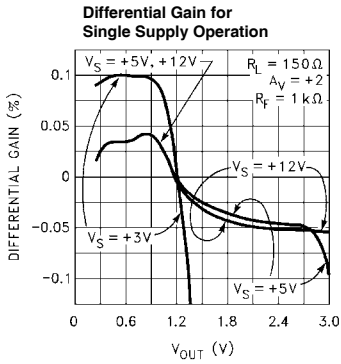



Typical Performance Curves (Continued)

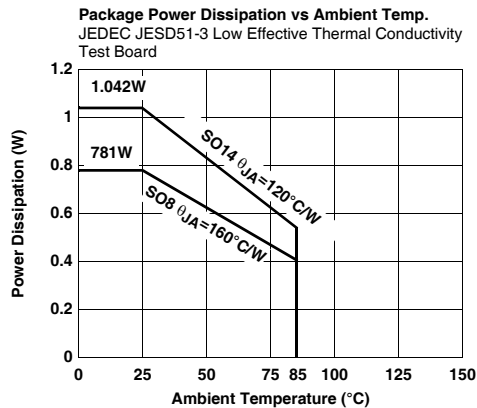
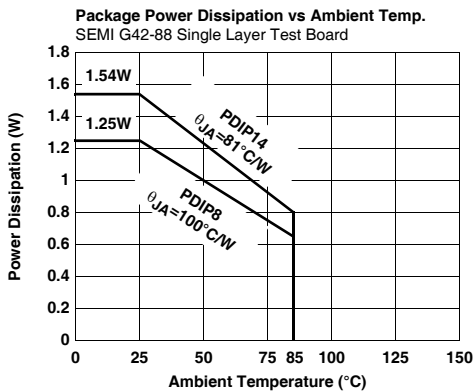
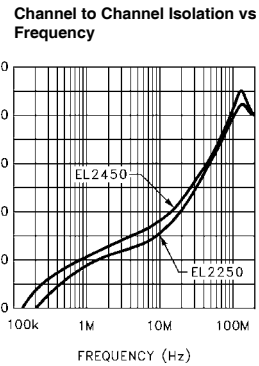
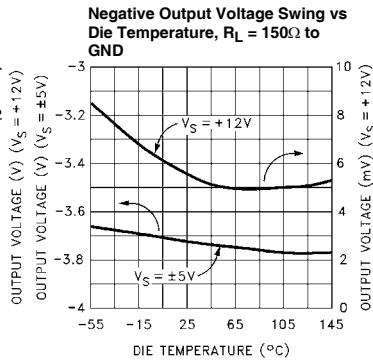
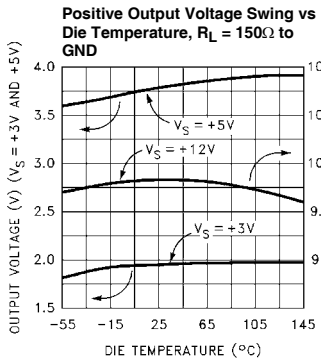
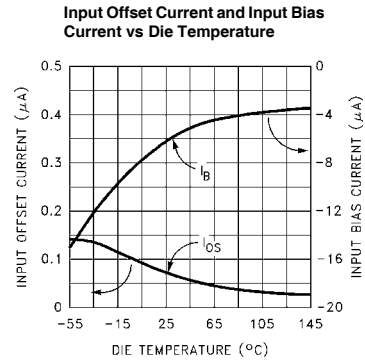
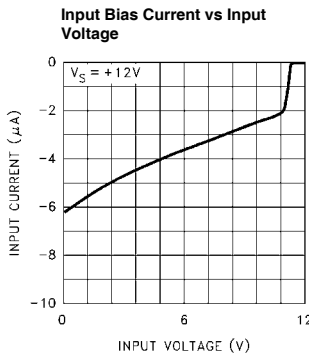
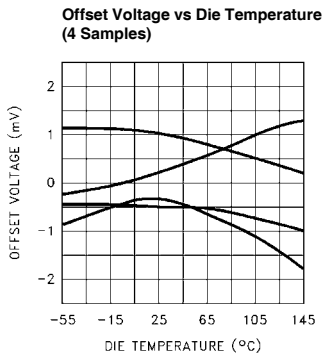
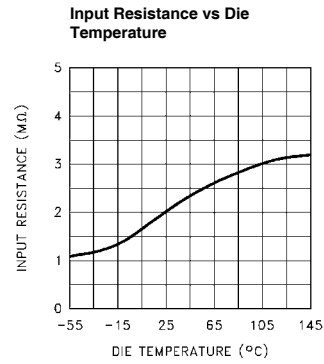
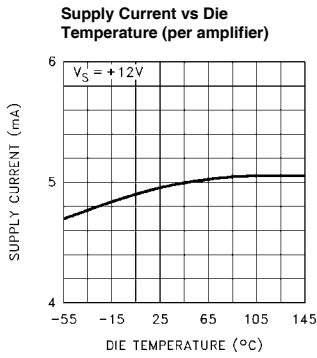
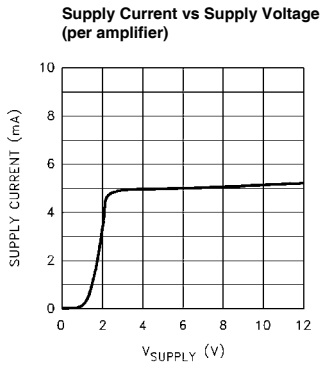



The output range of the EL2250/EL2450 is also quite large. It includes the negative rail, and extends to within 1V of the top supply rail with a 1k $\Omega$  load. On a +5V supply, the output is therefore capable of swinging from 0V to +4V. On split supplies, the output will swing  $\pm 4$ V. If the load resistor is tied to the negative rail and split supplies are used, the output range is extended to the negative rail.

**Choice Of Feedback Resistor,  $R_F$**

The feedback resistor forms a pole with the input capacitance. As this pole becomes larger, phase margin is reduced. This increases ringing in the time domain and peaking in the frequency domain. Therefore,  $R_F$  has some maximum value which should not be exceeded for optimum performance. If a large value of  $R_F$  must be used, a small capacitor in the few picofarad range in parallel with  $R_F$  can help to reduce this ringing and peaking at the expense of reducing the bandwidth.

As far as the output stage of the amplifier is concerned,  $R_F + R_G$  appear in parallel with  $R_L$  for gains other than +1. As this combination gets smaller, the bandwidth falls off. Consequently,  $R_F$  has a minimum value that should not be exceeded for optimum performance.

For  $A_V = +1$ ,  $R_F = 0\Omega$  is optimum. For  $A_V = -1$  or +2 (noise gain of 2), optimum response is obtained with  $R_F$  between 500 $\Omega$  and 1k $\Omega$ . For  $A_V = -4$  or +5 (noise gain of 5), keep  $R_F$  between 2k $\Omega$  and 10k $\Omega$ .

**Video Performance**

For good video performance, an amplifier is required to maintain the same output impedance and the same frequency response as DC levels are changed at the output. This can be difficult when driving a standard video load of 150 $\Omega$ , because of the change in output current with DC level. Differential Gain and Differential Phase for the EL2250/EL2450 are specified with the black level of the output video signal set to +1.2V. This allows ample room for the sync pulse even in a gain of +2 configuration. This results in dG and dP specifications of 0.05% and 0.05 $^\circ$  while driving 150 $\Omega$  at a gain of +2. Setting the black level to other values, although acceptable, will compromise peak performance. For example, looking at the single supply dG and dP curves for  $R_L = 150\Omega$ , if the output black level clamp is reduced from 1.2V to 0.6V dG/dP will increase from 0.05%/0.05 $^\circ$  to 0.08%/0.25 $^\circ$ . Note that in a gain of +2 configuration, this is the lowest black level allowed such that the sync tip doesn't go below 0V.

If your application requires that the output goes to ground, then the output stage of the EL2250/EL2450, like all other single supply op amps, requires an external pull down resistor tied to ground. As mentioned above, the current flowing through this resistor becomes the DC bias current for the output stage NPN transistor. As this current approaches zero, the NPN turns off, and dG and dP will increase. This becomes more critical as the load resistor is increased in

value. While driving a light load, such as 1k $\Omega$ , if the input black level is kept above 1.25V, dG and dP are a respectable 0.03% and 0.03 $^\circ$ .

For other biasing conditions see the Differential Gain and Differential Phase vs. Input Voltage curves.

**Output Drive Capability**

In spite of their moderately low 5mA of supply current, the EL2250/EL2450 are capable of providing  $\pm 100$ mA of output current into a 10 $\Omega$  load, or  $\pm 60$ mA into 50 $\Omega$ . With this large output current capability, a 50 $\Omega$  load can be driven to  $\pm 3$ V with  $V_S = \pm 5$ V, making it an excellent choice for driving isolation transformers in telecommunications applications.

**Driving Cables and Capacitive Loads**

When used as a cable driver, double termination is always recommended for reflection-free performance. For those applications, the back-termination series resistor will decouple the EL2250/EL2450 from the cable and allow extensive capacitive drive. However, other applications may have high capacitive loads without a back-termination resistor. In these applications, a small series resistor (usually between 5 $\Omega$  and 50 $\Omega$ ) can be placed in series with the output to eliminate most peaking. The gain resistor ( $R_G$ ) can then be chosen to make up for any gain loss which may be created by this additional resistor at the output.

**Video Sync Pulse Remover Application**

All CMOS Analog to Digital Converters (A/Ds) have a parasitic latch-up problem when subjected to negative input voltage levels. Since the sync tip contains no useful video information and it is a negative going pulse, we can chop it off.

Figure 1 shows a unity gain connected amplifier A of an EL2250. Figure 2 shows the complete input video signal applied at the input, as well as the output signal with the negative going sync pulse removed.

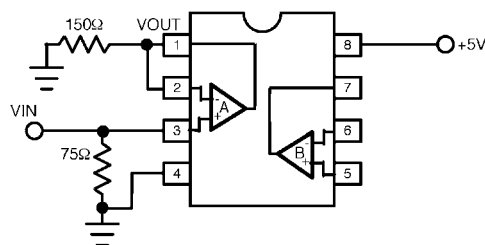

FIGURE 1.

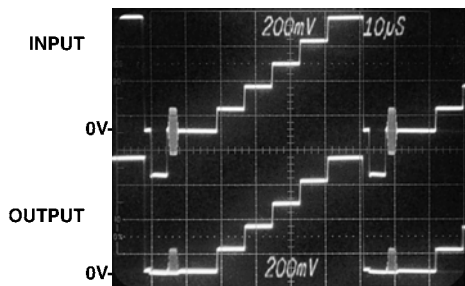

FIGURE 2.

**Short Circuit Current Limit**

The EL2250/EL2450 have internal short circuit protection circuitry that protect it in the event of its output being shorted to either supply rail. This limit is set to around 100mA nominally and reduces with increasing junction temperature. It is intended to handle temporary shorts. If an output is shorted indefinitely, the power dissipation could easily increase such that the part will be destroyed. Maximum reliability is maintained if the output current never exceeds ±90mA. A heat sink may be required to keep the junction temperature below absolute maximum when an output is shorted indefinitely.

**Power Dissipation**

With the high output drive capability of the EL2250/EL2450, it is possible to exceed the 150°C Absolute Maximum junction temperature under certain load current conditions. Therefore, it is important to calculate the maximum junction temperature for the application to determine if power-supply voltages, load conditions, or package type need to be modified for the EL2250/EL2450 to remain in the safe operating area.

The maximum power dissipation allowed in a package is determined according to [1]:

$$PD_{MAX} = \frac{T_{JMAX} - T_{AMAX}}{\theta_{JA}}$$

where:

$T_{JMAX}$  = Maximum Junction Temperature

$T_{AMAX}$  = Maximum Ambient Temperature

$\theta_{JA}$  = Thermal Resistance of the Package

$PD_{MAX}$  = Maximum Power Dissipation in the Package.

The maximum power dissipation actually produced by an IC is the total quiescent supply current times the total power supply voltage, plus the power in the IC due to the load, or [2]:

$$PD_{MAX} = N \times \left( V_S \times I_{SMAX} + (V_S - V_{OUT}) \times \frac{V_{OUT}}{R_L} \right)$$

where:

$N$  = Number of amplifiers

$V_S$  = Total Supply Voltage

$I_{SMAX}$  = Maximum Supply Current per amplifier

$V_{OUT}$  = Maximum Output Voltage of the Application

$R_L$  = Load Resistance tied to Ground

If we set the two  $PD_{MAX}$  equations, [1] & [2], equal to each other, and solve for  $V_S$ , we can get a family of curves for various loads and output voltages according to [3]:

$$V_S = \frac{\frac{R_L \times (T_{JMAX} - T_{AMAX})}{N \times \theta_{JA}} + (V_{OUT})}{(I_S \times R_L) + V_{OUT}}$$

Figures 3 through 6 below show total single supply voltage  $V_S$  vs.  $R_L$  for various output voltage swings for the PDIP and SO packages. The curves assume WORST CASE conditions of  $T_A = +85^\circ\text{C}$  and  $I_S = 6.5\text{mA}$  per amplifier.

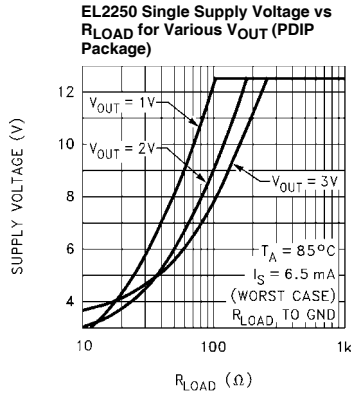

FIGURE 3.

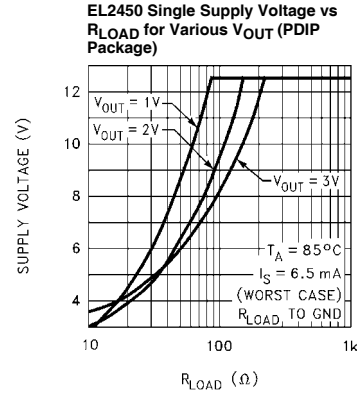

FIGURE 5.

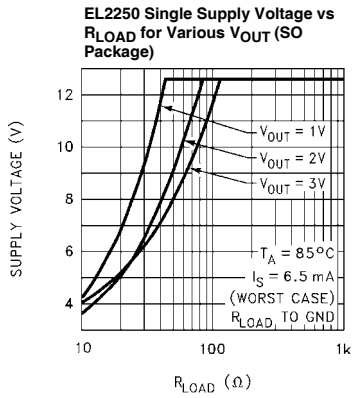

FIGURE 4.

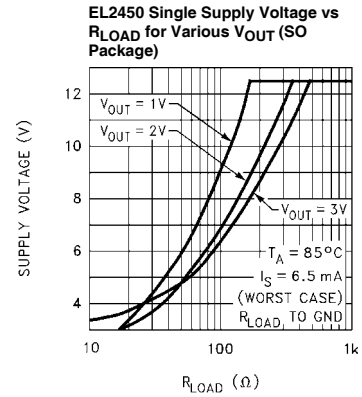

FIGURE 6.

**EL2250/EL2450 Macromodel** (one amplifier)

\* Revision A, April 1996

\* Pin numbers reflect a standard single op amp.

\* Connections:

	+input				
	-input		+Vsupply		
			-Vsupply		
				output	

.subckt EL2250/el 3 2 7 4 6

\* Input Stage

i1 7 10 250µA  
i2 7 11 250µA  
r1 10 11 4k  
q1 12 2 10 qp  
q2 13 3 11 qpa  
r2 12 4 100  
r3 13 4 100

\* Second Stage & Compensation

gm 15 4 13 12 4.6m  
r4 15 4 15Meg  
c1 15 4 0.36pF

\* Poles

e1 17 4 15 4 1.0  
r6 17 25 400  
c3 25 4 1pF  
r7 25 18 500  
c4 18 4 1pF

\* Output Stage

i3 20 4 1.0mA  
q3 7 23 20 qn  
q4 7 18 19 qn  
q5 7 18 21 qn  
q6 4 20 22 qp  
q7 7 23 18 qn  
d1 19 20 da  
r8 21 6 2  
r9 22 6 2  
r10 18 21 10k  
r11 7 23 100k  
d2 23 24 da  
d3 24 4 da  
d4 23 18 da

\* Power Supply Current

ips 7 4 3.2mA

\* Models

.model qn npn(is=800e-18 bf=150 tf=0.02nS)  
.model qpa pnp(is=810e-18 bf=50 tf=0.02nS)  
.model qp pnp(is=800e-18 bf=54 tf=0.02nS)  
.model da d(tt=0nS)  
.ends

**EL2250/EL2450 Macromodel** (one amplifier)

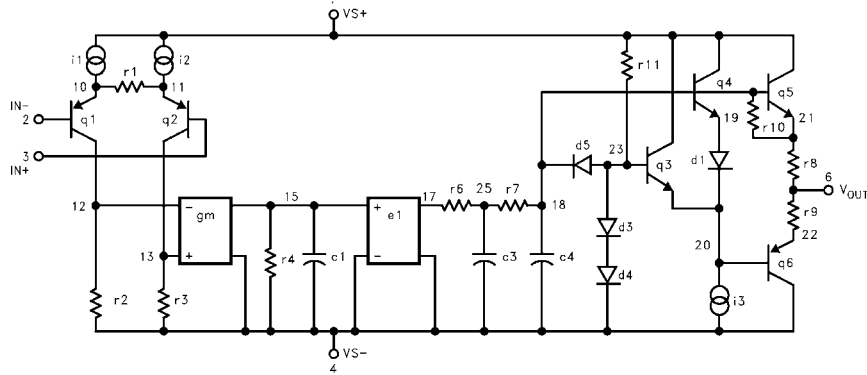

All Intersil U.S. products are manufactured, assembled and tested utilizing ISO9000 quality systems.  
Intersil Corporation's quality certifications can be viewed at [www.intersil.com/design/quality](http://www.intersil.com/design/quality)

*Intersil products are sold by description only. Intersil Corporation reserves the right to make changes in circuit design, software and/or specifications at any time without notice. Accordingly, the reader is cautioned to verify that data sheets are current before placing orders. Information furnished by Intersil is believed to be accurate and reliable. However, no responsibility is assumed by Intersil or its subsidiaries for its use; nor for any infringements of patents or other rights of third parties which may result from its use. No license is granted by implication or otherwise under any patent or patent rights of Intersil or its subsidiaries.*

For information regarding Intersil Corporation and its products, see [www.intersil.com](http://www.intersil.com)