

Features

- High accuracy DC restoration for video
- Low supply current of 9.5 mA typ.
- 300 MHz bandwidth
- 1500V/ μ s slew rate
- 0.04% differential gain and 0.02° differential phase into 150 Ω for NTSC
- 1.5 mV max. restored DC offset
- Sample and hold amplifier with fast enable and low leakage
- TTL-compatible HOLD logic input

Applications

- Input amplifier in video equipment
- Restoration amplifier in video mixers

Ordering Information

Part No.	Temp. Range	Package	Outline #
EL4093CN	-40°C to +85°C	16-pin P-DIP	MDP0031
EL4093CS	-40°C to +85°C	16-Lead SOIC	MDP0027

Demo Board

A demo PCB is available for this product. Request "EL4093 Demo Board."

General Description

The EL4093C is a complete DC-restored video amplifier subsystem, featuring low power consumption and high slew rate. It contains a current feedback amplifier and a sample and hold amplifier designed to stabilize video performance. When the HOLD logic input is low, the sample and hold may be used as a general purpose op amp to null the DC offset of the video amplifier. When the HOLD input goes high the sample and hold stores the correction voltage on the hold capacitor to maintain DC correction during the subsequent video scan line.

The sample and hold amplifier contains a current output stage that greatly simplifies its connection to the video amplifier. Its high output impedance also helps to preserve video linearity at low supply voltages. For ease of interfacing, the HOLD input is TTL-compatible. This device has an operational temperature of -40°C to +85°C and is packaged in plastic 16-pin DIP and 16-lead SOIC.

Connection Diagram

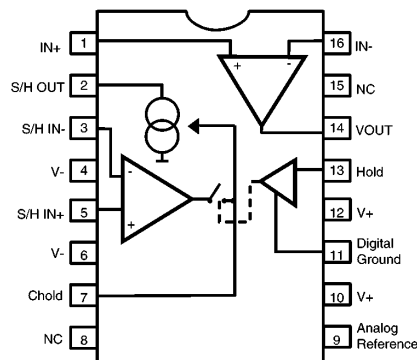

44093-1

Note: All information contained in this data sheet has been carefully checked and is believed to be accurate as of the date of publication; however, this data sheet cannot be a "controlled document". Current revisions, if any, to these specifications are maintained at the factory and are available upon your request. We recommend checking the revision level before finalization of your design documentation.

EL4093C

300 MHz DC-Restored Video Amplifier

Absolute Maximum Ratings

V_S	V+ to V- Supply Voltage	12.6V	$I_{OUT2S/H}$ amplifier output current	± 10 mA
V_{HOLD}	Voltage at HOLD input		I_{IN} Maximum current into other pins	± 6 mA
	(DGND - 0.7) to (DGND + 5.5V)		P_D Maximum Power Dissipation	See Curves
V_{IN}	Voltage at any other input	V+ to V-	T_A Operating Ambient Temperature Range	-40°C to +85°C
ΔV_{IN}	Difference between Sample and Hold inputs	$\pm 8V$	T_J Operating Junction Temperature	150°C
I_{OUT1}	Video amplifier output current	± 30 mA	T_{ST} Storage Temperature Range	-65°C to +150°C

Important Note:

All parameters having Min/Max specifications are guaranteed. The Test Level column indicates the specific device testing actually performed during production and Quality inspection. Elantec performs most electrical tests using modern high-speed automatic test equipment, specifically the LTX77 Series system. Unless otherwise noted, all tests are pulsed tests, therefore $T_J = T_C = T_A$.

Test Level	Test Procedure
I	100% production tested and QA sample tested per QA test plan QCX0002.
II	100% production tested at $T_A = 25^\circ\text{C}$ and QA sample tested at $T_A = 25^\circ\text{C}$, T_{MAX} and T_{MIN} per QA test plan QCX0002.
III	QA sample tested per QA test plan QCX0002.
IV	Parameter is guaranteed (but not tested) by Design and Characterization Data.
V	Parameter is typical value at $T_A = 25^\circ\text{C}$ for information purposes only.

Open-Loop DC Electrical Characteristics

Power supplies at $\pm 5V$, $T_A = 25^\circ\text{C}$

Parameter	Description	Min	Typ	Max	Test Level	Units
$I_{S,HOLD}$	Total Supply current in HOLD mode		9.5	11.5	I	mA
$I_{S,SAMPLE}$	Total Supply current in SAMPLE mode		8.5	10.5	I	mA

Video Amplifier Section (Not Restored)

Parameter	Description	Min	Typ	Max	Test Level	Units
V_{OS}	Input Offset Voltage		10	110	I	mV
I_{B+}	Non-Inverting Input Bias Current		10	25	I	μA
I_{B-}	Inverting Input Bias Current		15	50	I	μA
R_{OL}	Transimpedance $V_{OUT} = \pm 2.5V$, $R_L = 150\Omega$	150	400		I	$\text{k}\Omega$
V_O	Output Voltage Swing $R_L = 150\Omega$	± 3	± 3.5		I	V
I_{SC}	Output Short-Circuit Current	60	100		I	mA

EL4093C

300 MHz DC-Restored Video Amplifier

Open-Loop DC Electrical Characteristics

Power supplies at $\pm 5V$, $T_A = 25^\circ C$ — Contd.

Sample and Hold Section

Parameter	Description	Min	Typ	Max	Test Level	Units
V_{OS}	Input Offset Voltage		0.5	1.5	I	mV
TCV_{OS}	Average Offset Voltage Drift		6		V	$\mu V/^\circ C$
I_B	Input Bias Current		1	2	I	μA
I_{OS}	Input Offset Current		10	200	I	nA
TCI_{OS}	Average Offset Current Drift		0.1		V	$nA/^\circ C$
V_{CM}	Common Mode Input Range	± 2.5	± 2.8		I	V
g_m	Transconductance ($R_L = 500\Omega$)	5	15		I	A/V
CMRR	Common Mode Rejection Ratio ($V_{CM} - 2.5V$ to $+2.5V$)	70	90		I	dB
V_{IL}	HOLD Logic Input Low (referenced to Digital GND)			0.8	I	V
V_{IH}	HOLD Logic Input High (referenced to Digital GND)	2.0			I	V
V_{GND}	Digital GND Reference Voltage	(V-)		(V+) - 4.0	I	V
I_{DROOP}	Hold Mode Droop Current		10	70	I	nA
I_{CHARGE}	Charge Current Available to C_{HOLD}	± 5.5	± 8.5		I	mA
V_O	Output Voltage Swing ($R_L = 10k\Omega$)	± 3	± 3.5		I	V
I_O	Output Current Swing ($R_L = 0\Omega$)	± 4.5	± 5.5		I	mA

Closed-Loop AC Electrical Characteristics

Power supplies at $\pm 5V$, $T_A = 25^\circ C$, $R_F = R_G = 750\Omega$, $R_L = 150\Omega$, $C_L = 5$ pF, $C_{IN} - (\text{parasitic}) = 1.8$ pF

Video Amplifier Section

Parameter	Description	Min	Typ	Max	Test Levels	Units
BW, -3 dB	-3 dB Small-Signal Bandwidth		300		V	MHz
BW, ± 0.1 dB	0.1 dB Flatness Bandwidth		50		V	MHz
Peaking	Frequency Response Peaking		0		V	dB
SR	Slew rate, V_{OUT} between $-2V$ and $+2V$		1500		V	V/ μs
dG	Differential Gain Error, Voffset between -714 mV and $+714$ mV		0.04		V	%
d θ	Differential Phase Error, Voffset between -714 mV and $+714$ mV		0.02		V	$^\circ$

EL4093C

300 MHz DC-Restored Video Amplifier

Closed-Loop AC Electrical Characteristics

Power supplies at $\pm 5V$, $T_A = 25^\circ C$, $R_F = R_G = 750\Omega$, $R_L = 150\Omega$, $C_L = 5\text{ pF}$, $C_{HOLD} = 2.2\text{ nF}$

Sample and Hold Section

Parameter	Description	Min	Typ	Max	Test Levels	Units
ΔI_{STEP}	Change in Sample to Hold Output Current Due to Hold Step		0.1		V	μA
ΔT_{SH}	Sample to Hold Delay Time		15		V	ns
ΔT_{HS}	Hold to Sample Delay Time		40		V	ns
T_{AC}	Settling Time to 1% (DC Restored Amplifier Output) Video Amplifier Input from 0 to 1V		2.2		V	μs

Typical Application

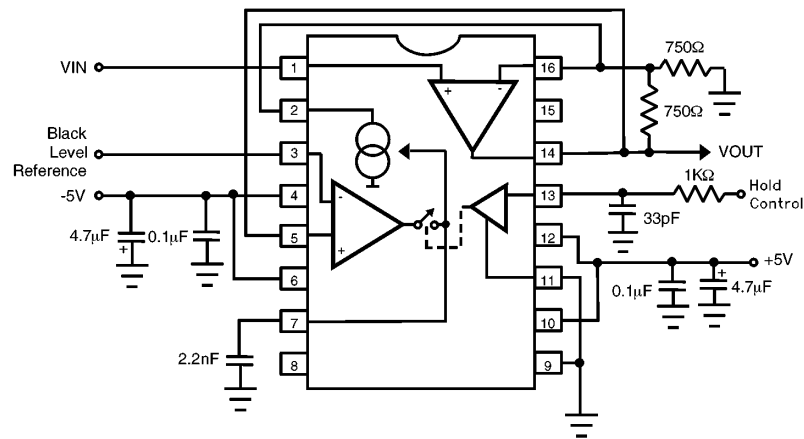

44093-2

EL4093C

300 MHz DC-Restored Video Amplifier

Typical Performance Curves

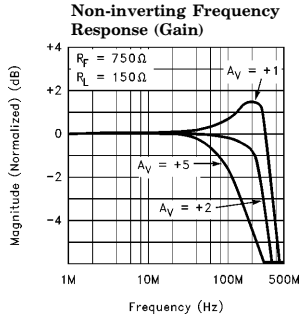

44093-4

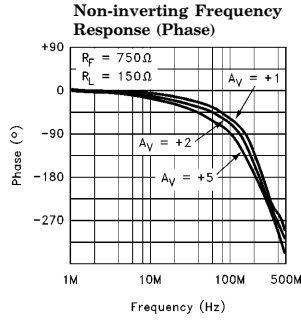

44093-5

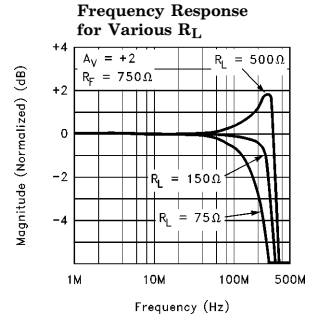

44093-6

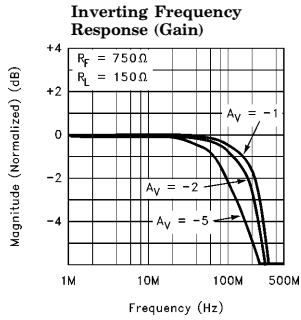

44093-7

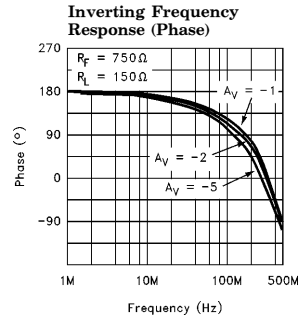

44093-8

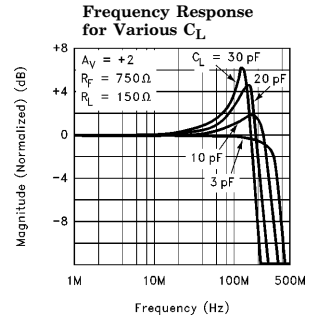

44093-9

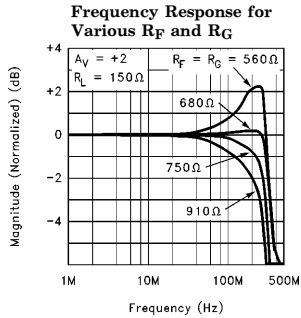

44093-10

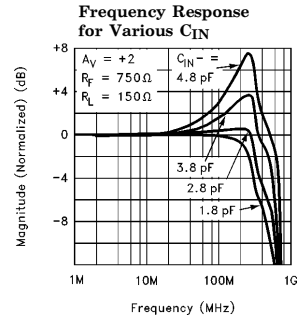

44093-11

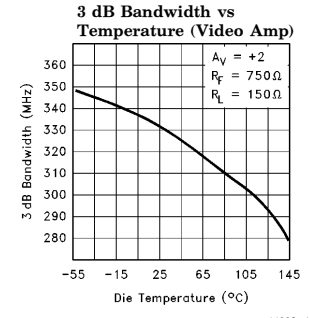

44093-12

EL4093C

300 MHz DC-Restored Video Amplifier

Typical Performance Curves — Contd.

Peaking vs Temperature (Video Amp)

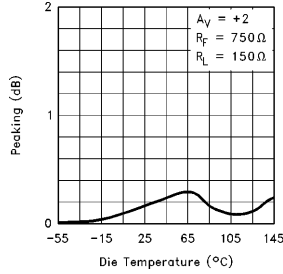

Output Voltage Swing vs Frequency

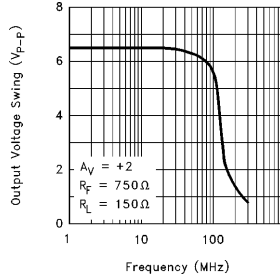

2nd and 3rd Harmonic Distortion vs Frequency

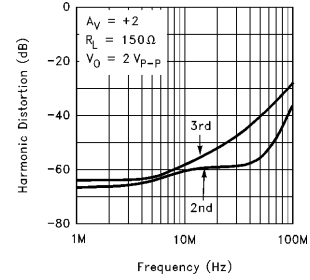

Voltage and Current Noise vs Frequency

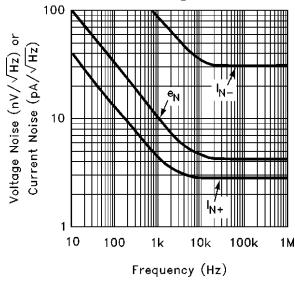

Supply Current vs Temperature

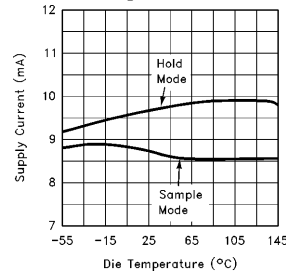

Input Offset Voltage vs Die Temperature (Video Amp, 3 Sample)

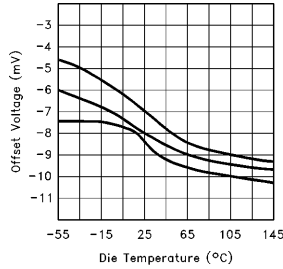

Input Bias Current vs Temperature (Video Amp)

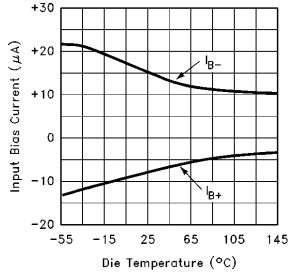

Transimpedance vs Temperature (Video Amp)

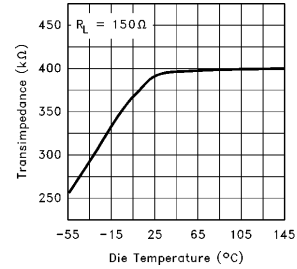

EL4093C

300 MHz DC-Restored Video Amplifier

Typical Performance Curves — Contd.

Input Offset Voltage vs Die Temperature (Sample & Hold, 3 Samples)

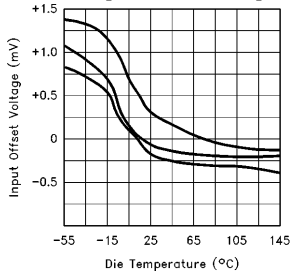

44093-21

Input Bias Current vs Die Temperature (Sample & Hold)

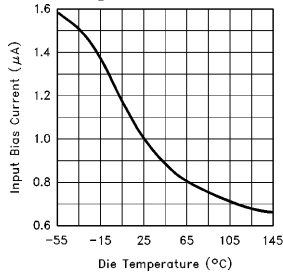

44093-22

Transconductance vs Temperature (Sample & Hold)

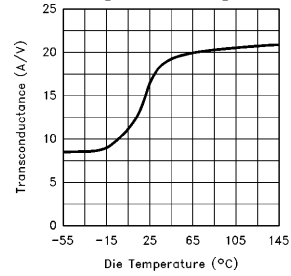

44093-23

Transconductance vs Die Temperature (Sample & Hold)

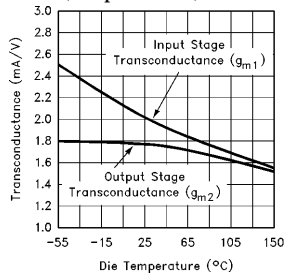

44093-38

Output Current Swing vs Temperature (Sample & Hold)

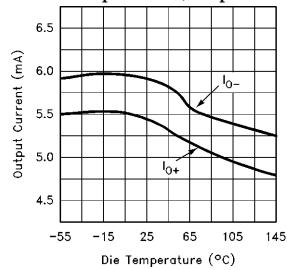

44093-25

Drop Current vs Temperature (Sample & Hold)

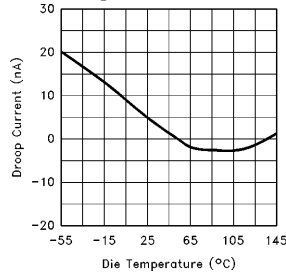

44093-26

Charge Current vs Temperature (Sample & Hold)

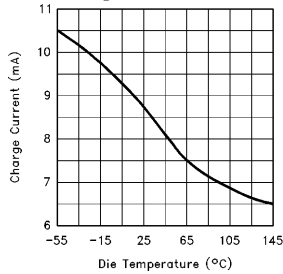

44093-27

Hold Step (ΔI_{OUT}) vs Temperature

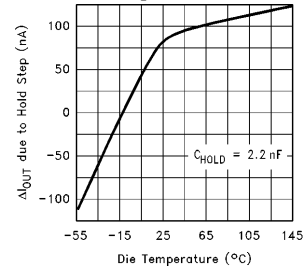

44093-28

EL4093C

300 MHz DC-Restored Video Amplifier

Typical Performance Curves — Contd.

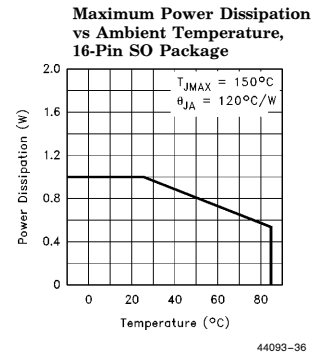
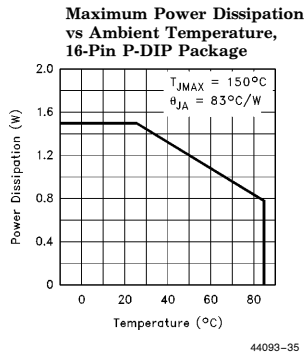
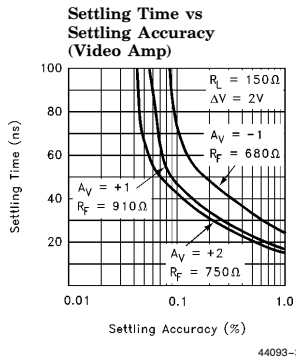
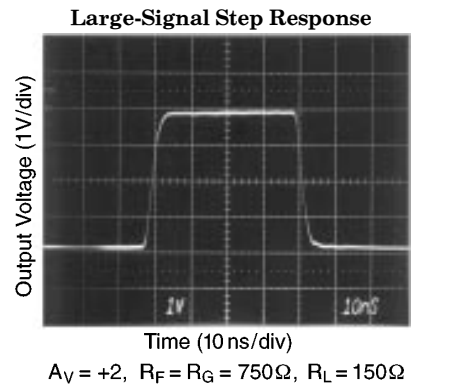
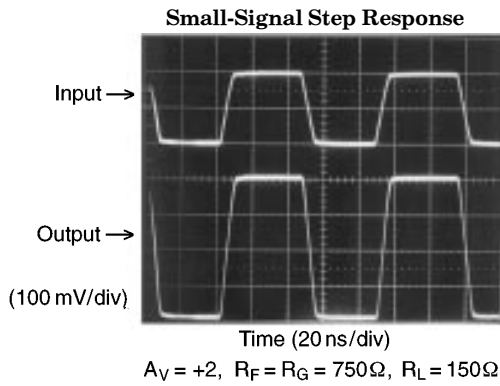
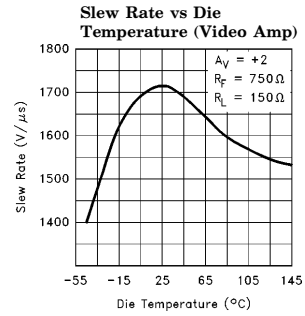
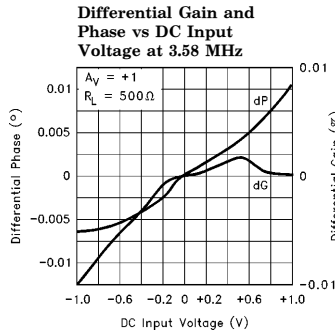
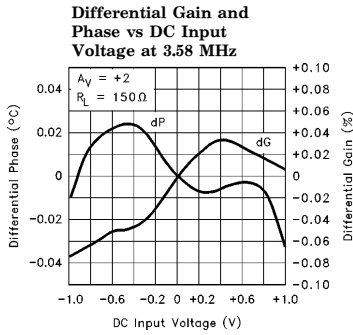

EL4093C

300 MHz DC-Restored Video Amplifier

Applications Information

Product Description

The EL4093C is a high speed DC-restore system containing a current feedback amplifier (CFA) and a sample & hold (S/H) amplifier. The CFA offers a wide 3 dB bandwidth of 300 MHz and a slew rate of 1500 V/ μ s, making it ideal for high speed video applications such as SVGA. The CFA's excellent differential gain and phase at 3.58 MHz also makes it suitable for NTSC applications. Drawing only 9.5 mA on ± 5 V supplies, the EL4093C serves as an excellent choice for those applications requiring both low power and high bandwidth.

The connection between the CFA and sample & hold (the Autozero interface) has been greatly simplified. The output of the sample & hold is a high impedance current source, allowing direct connection to the CFA inverting input for autozero purposes. In addition, special circuitry within the sample & hold provides a charge current of 8.5 mA in sample mode, resulting in a sample hold current ratio (ratio of charging current to droop current) of approx. 1,000,000.

Theory of Operation

In video applications, DC restoration moves the backporch or black level to a fixed DC reference. The EL4093C uses a CFA in feedback with a sample & hold to provide DC restoration. Figure 1 shows how the two are connected to provide this function; the S/H compares the output of the CFA to a DC reference, and any difference between them causes an output current from the S/H. This "autozero" current is fed to the CFA inverting input, the effect of which is to move the CFA output towards the reference voltage. This autozero mechanism settles when the CFA output is one V_{OS} away from the reference (the V_{OS} here refers to the S/H offset voltage).

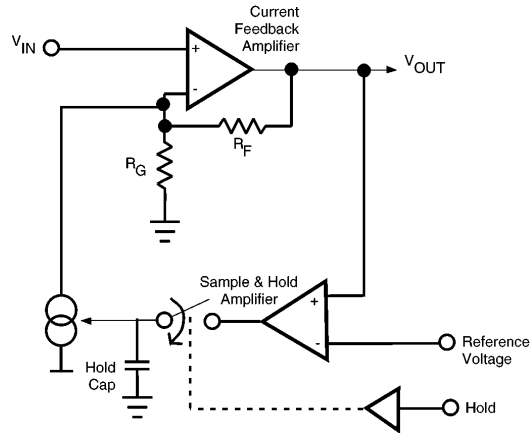

Figure 1

The autozero mechanism is typically active for only a short period of each video line. Figure 2 shows a NTSC video signal along with the EL4581C back porch output. The back porch signal is used to drive the HOLD input of the EL4093C, and we see that the EL4093C is in sample mode for only 3.5 μ s of each line. It is during this time that the autozero mechanism attempts to drive the CFA output towards the reference voltage, at the same time putting a correction voltage onto the hold capacitor C_{HOLD} . During the rest of the line (60 μ s) the EL4093C is in hold mode, but DC correction is maintained by the voltage on C_{HOLD} .

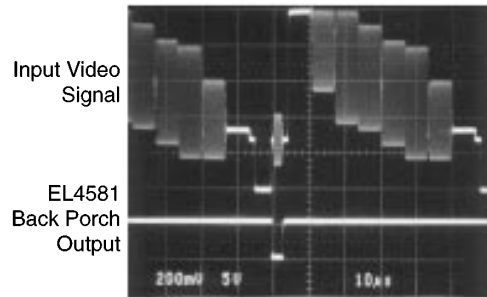

Figure 2

EL4093C

300 MHz DC-Restored Video Amplifier

Applications Information — Contd.

Power Supply Bypassing and Printed Circuit Board Layout

As with any high frequency device, good printed circuit board layout is necessary for optimum performance. Ground plane construction is highly recommended. Lead lengths should be as short as possible. The power supply pins must be well bypassed to reduce the risk of oscillation. In the EL4093C there are two sets of supply pins: V+1/V-1 provide power for the CFA, and V+2/V-2 are for the S/H amplifier. Good performance can be achieved using only one set of bypass capacitors, although they must be close to the V+1/V-1 pins since that is where the high frequency currents flow. The combination of a 4.7 μF tantalum capacitor in parallel with a 0.01 μF capacitor has been shown to work well. Chip capacitors are recommended for the 0.01 μF bypass to minimize lead inductance.

For good AC performance, parasitic capacitance should be kept to a minimum, especially at the CFA inverting input. Ground plane construction should be used, but it should be removed from the area near the inverting input to minimize any stray capacitance at that node. Chip resistors are recommended for R_F and R_G , and use of sockets should be avoided if possible. Sockets add parasitic inductance and capacitance which will result in some additional peaking and overshoot.

If the CFA is configured for non-inverting gain, then one should also pay attention to the trace leading to the + input. The inductance of a long trace ($> 3''$) can form a resonant network with the amplifier input, resulting in high frequency oscillations around 700 MHz. In such cases a 50 Ω –100 Ω series resistor placed close to the + input would isolate this inductance and damp out the resonance.

Capacitance at the Inverting Input

Any manufacturer's high-speed voltage or current feedback amplifier can be affected by stray capacitance at the inverting input. For inverting gains this parasitic capacitance has little effect because the inverting input is a virtual ground, but for non-inverting gains this capacitance (in

conjunction with the feedback and gain resistors) creates a pole in the feedback path of the amplifier. This pole, if low enough in frequency, has the same destabilizing effect as a zero in the forward open-loop response. Hence it is important to minimize the stray capacitance at this node by removing the nearby ground plane. In addition, since the S/H output connects to this node, it is important to minimize the trace capacitance. Good practice here would be to connect the two pins with a short trace directly underneath the chip.

Feedback Resistor Values

The EL4093C has been optimized for a gain of +2 with $R_F = 750\Omega$. This value of feedback resistor gives a 3 dB bandwidth of 300 MHz at a gain of +2 driving a 150 Ω load. Since the amplifier inside the EL4093C uses current mode feedback, it is possible to change the value of R_F to adjust the bandwidth. Shown in the table below are optimum feedback resistor values for different closed loop gains.

Gain	Optimum R_F	BW (MHz)	Peaking (dB)
+1	910	314	0.2
+2	750	300	0
+5	470	294	0.2
-1	680	300	0

Autozero Interface

The autozero interface refers to the connection between the S/H output and the CFA inverting input. This interface has been greatly simplified compared to that of the EL2090C, in that the S/H output is a high impedance current source. The S/H output can be connected directly to the inverting input, and its high impedance greatly reduces the interaction between the sample & hold and the gain setting resistors. Another virtue of this interface is better gain linearity as the autozero current changes. For example, at an autozero current of 0 mA the output impedance is about 5 M Ω , dropping to 1 M Ω as the autozero current increases to 3 mA. Using $R_F = R_G = 750\Omega$, the closed loop gain changes only by 0.025% in this interval.

EL4093C

300 MHz DC-Restored Video Amplifier

Applications Information — Contd.

Autozero Range

The autozero range is defined as the difference between the input DC level and the reference voltage to restore to. The size of this range is a function of the gain setting resistors used and the S/H output current swing. For a gain of +2 the optimum feedback resistor is 750Ω , and the available S/H output current is ± 5.5 mA minimum. To determine the autozero range for this case, we refer to Figure 3 below.

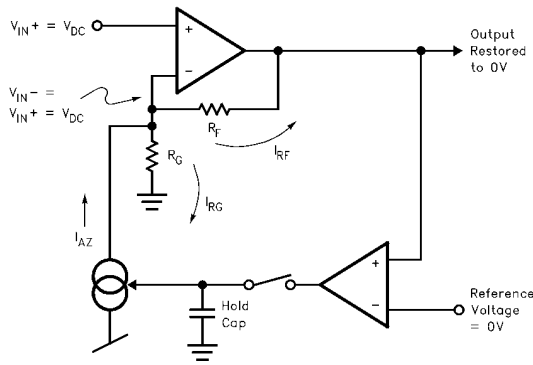

Figure 3

Suppose that the input DC level is $+V_{DC}$, and that the reference voltage is $0V$. We know that in feedback, the following two conditions will exist on the CFA: first, its output will be equal to $0V$ (due to autozero), and second, its V_{IN-} voltage is equal to the V_{IN+} voltage (i.e. $V_{IN-} = +V_{DC}$). So we have a potential difference of $+V_{DC}$ across both R_F and R_G , resulting in a current $I_{RF} = I_{RG} = V_{DC}/750\Omega$ that must flow into each of them. This current $I_{AZ} = (I_{RF} + I_{RG})$ must come from the S/H output. Since the maximum that I_{AZ} can be is 5.5 mA, we can solve for V_{DC} using the following:

$$I_{AZ} = \pm 5.5 \text{ mA} = 2 \left(\frac{V_{DC}}{750\Omega} \right)$$

and see that $V_{DC} = \pm 2V$. This range can easily accommodate most video signals.

As another example, consider the case where we are restoring to a reference voltage of $+0.75V$. Using the same reasoning as above, a current $I_{RF} = (V_{DC} - 0.75V)/R_F$ must flow through R_F , and a current $I_{RG} = V_{DC}/R_G$ must go into R_G . Again, our boundary condition is that $I_{RF} + I_{RG} \leq \pm 5.5$ mA, and we can solve for the allowable V_{DC} values using the following:

$$\pm 5.5 \text{ mA} = \frac{V_{DC} - 0.75V}{750\Omega} + \frac{V_{DC}}{750\Omega}$$

Hence V_{DC} must be between $+2.4V$ to $-1.7V$. This example illustrates that when the reference changes, the autozero range also changes. In general, the user should determine the autozero range for his/her application, and ensure that the input signal is within this range during the autozero period.

Autozero Loop Bandwidth

The gain-bandwidth product (GBWP) of the autozero loop is determined by the size of the hold capacitor, the value of R_F , and the transconductances (gm 's) of the S/H amplifier. To begin, the S/H amplifier is modeled as in Figure 4 below. First, the input stage transconductance is represented by gm_1 , with the compensation capacitor given by C_{HOLD} . This stage's GBWP is thus $gm_1/(2\pi \cdot C_{HOLD}) = 1/(2\pi \cdot (350\Omega)(2.2 \text{ nF})) = 207$ kHz. Next, since the S/H has a current output, its output stage can be modeled as a transconductance gm_2 , in this case having a value of $1/(500\Omega)$. The current from gm_2 then flows through the I to V converter made up of the CFA and R_F to produce a voltage gain. Thus the GBWP of the overall loop is given by:

$$GBWP = \frac{gm_1}{2\pi \cdot C_{HOLD}} (gm_2 \cdot R_F)$$

EL4093C

300 MHz DC-Restored Video Amplifier

Applications Information — Contd.

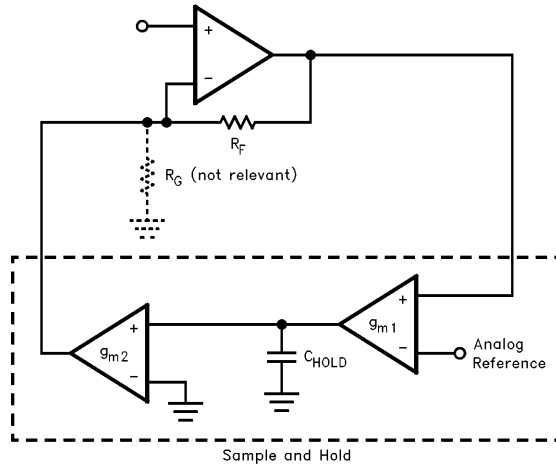

Figure 4

4093-40

With $R_F = 750\Omega$, a GBWP of 310 kHz is obtained. Note however that this is the small signal GBWP. As mentioned earlier, the sample and hold has special boost circuits built in which provides ± 8.5 mA of charge current during full slew. These boost circuits turn on when the S/H input differential voltage exceeds ± 50 mV. When the boosters are turned on, $gm1$ greatly increases and the circuit becomes nonlinear. Thus some stability issues are associated with the boosters, and they will be addressed in a later section.

Charge Injection and Hold Step

Charge injection refers to the charge transferred to the hold capacitor when switching to the HOLD mode. The charge should ideally be 0, but due to stray capacitive coupling and other effects, is typically 0.1 pC in the EL4093. This charge changes the hold capacitor voltage by $\Delta V = \Delta Q / C_{HOLD}$, and this ΔV is multiplied by the output stage transconductance ($gm2$) to produce a change in S/H output current. This last quantity is listed as the spec ΔI_{STEP} , and is calculated using the following:

$$\Delta I_{STEP} = \left(\frac{\Delta Q}{C_{HOLD}} \right) \cdot gm2$$

For $C_{HOLD} = 2.2$ nF and $gm2 = 1/(500\Omega)$, ΔI_{STEP} has a typical value of 100 nA. This change in S/H output current flows through R_F , shifting the CFA output voltage. However, as we shall soon see, this shift is negligible. Assuming $R_F = 750\Omega$, ΔI_{STEP} is impressed across R_F to give $(750\Omega)(100$ nA) = 0.08 mV of change at the CFA output.

Droop Rate

When the S/H amplifier is in HOLD mode, there is a small current that leaks from the switch into the hold capacitor. This quantity is termed the droop current, and is typically 10 nA in the EL4093. This droop current produces a ramp in the hold capacitor voltage, which in turn produces a similar effect at the CFA output. The Droop Rate at the CFA output can be found using the equation below:

$$\text{Droop} = \frac{I_{DROOP}}{C_{HOLD}} (gm2 \cdot R_F)$$

Assuming $R_F = 750\Omega$ and $C_{HOLD} = 2.2$ nF, the drift in the CFA output due to droop current is about $7 \mu\text{V}/\mu\text{s}$. Recall that in NTSC applications, there is about $60 \mu\text{s}$ between autozero periods. Thus there is $7 \mu\text{V}/\mu\text{s})(60 \mu\text{s}) = 0.4$ mV, or less than 0.1 IRE, of drift over each NTSC scan line. This drift is negligible in most applications.

EL4093C

300 MHz DC-Restored Video Amplifier

Applications Information — Contd.

Choice of Hold Capacitor

The EL4093 has been designed to work with a hold capacitor of 2.2 nF. With this value of C_{HOLD} , the droop rate and hold step are negligibly small for most applications. In addition, with the special boost circuits inside the S/H, fast acquisition is possible even using a hold capacitor of this size. Figure 5 below shows the input and output of the DC-restored amplifier while the S/H is in sample mode. Applying a +1V step to the non-inverting input of the CFA, the output of the CFA jumps to +2V. The S/H, however, then tries to autozero the system by driving the CFA output back to the reference voltage. Since the input differential across the S/H is initially +2V, the boost circuits turn on and supply 8.5 mA of charge current to the hold capacitor. The boost circuit remains on until the CFA output has come to within 50 mV of the reference. Note that this event took only 320 ns; settling to within 1% of the final value takes another 2 μs . Thus for a 1V input step, acquisition takes only one to two NTSC scan lines.

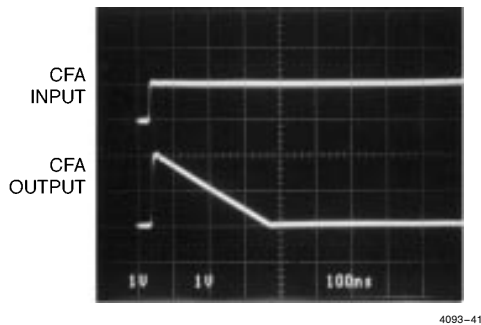

Figure 5. Autozero Mechanism Restores Amplifier Output to Ground after +1V Step at Input

A natural question arises as to whether there are other C_{HOLD} values that can be used. In one direction, increasing C_{HOLD} will further reduce the droop and hold step, but lengthen the acquisition time. Since the droop and hold step are already small to begin with, there is no apparent advantage to increasing C_{HOLD} .

In the other direction, decreasing C_{HOLD} would increase the droop and hold step but shorten the acquisition time. There is, however, a caveat to reducing C_{HOLD} : too small a C_{HOLD} would cause the autozero loop to oscillate. The reason is that when the S/H boost circuit turns on, the input stage gm increases drastically and the circuit becomes nonlinear. A sufficiently large C_{HOLD} must be used to suppress the non-linearity and force the loop to settle. For example, it has been found that a C_{HOLD} of 470 pF results in 1 $V_{\text{P-P}}$ oscillation around 10 MHz at the CFA output.

The minimum recommended value for C_{HOLD} is 2.2 nF. With this value the loop remains stable over the entire operating temperature range (-40°C to $+85^{\circ}\text{C}$). The greatest instability occurs at low temperatures, where we observe from the performance curves that the S/H gm's, and hence the GBWP, are at their maximum. If the operating range is restricted to room temperature or above, then 1.5 nF is sufficient to keep the loop stable. At this value of C_{HOLD} the acquisition time reduces to about 1.5 μs .

Video Performance and Application

Although the EL4093 is intended for high speed video applications such as SVGA, it also offers excellent performance for NTSC, with 0.04% dG and 0.02° dP at 3.58 MHz. Some application considerations, however, are required for handling NTSC signals.

Referring back to Figure 2, recall that typically, the autozero interval lies in the back porch portion of video containing the colorburst pulse. When the S/H compares the video to the reference voltage during this period, the colorburst (40 IRE_{P-P}) triggers the S/H boost circuit and prevents the autozero loop from settling.

EL4093C

300 MHz DC-Restored Video Amplifier

Applications Information — Contd.

A remedy for this situation is to attenuate the colorburst before applying it to the S/H input. Figure 6 below shows a 3.58 MHz chroma trap which would notch out the colorburst while preserving the video DC level.

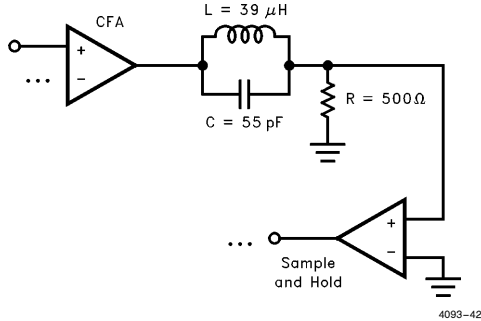

Figure 6. Colorburst Trap for NTSC Applications

One may be tempted to use a RC lowpass filter to suppress the colorburst, as shown in Figure 7 below. This technique, however, poses several problems. First, to obtain enough attenuation, we need to set the pole frequency 10 to 20 times lower than 3.58 MHz. This pole, being close to the auto zero loop pole, would destabilize the system and cause the loop to oscillate.

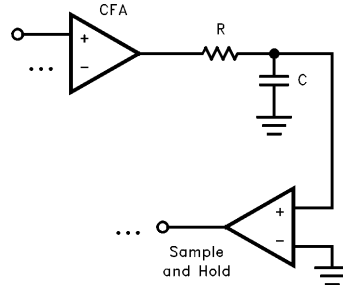

Figure 7. Caution: Lowpass Filter Does Not Work in NTSC Applications

Although we can cancel this pole by introducing a zero, the RC network introduces a time delay between the CFA output and the S/H input. This has undesirable effects in some NTSC applications, as Figure 8 below illustrates. There is only $0.6 \mu\text{s}$ from the rising edge of sync to the colorburst. If we are autozeroing over the back porch, the autozero period would begin somewhere in this $0.6 \mu\text{s}$ interval. Since the edge of sync is now delayed by the RC network, autozero begins before the video back porch reaches its final value. Consequently, the autozero loop performs a correction on every line and never settles.

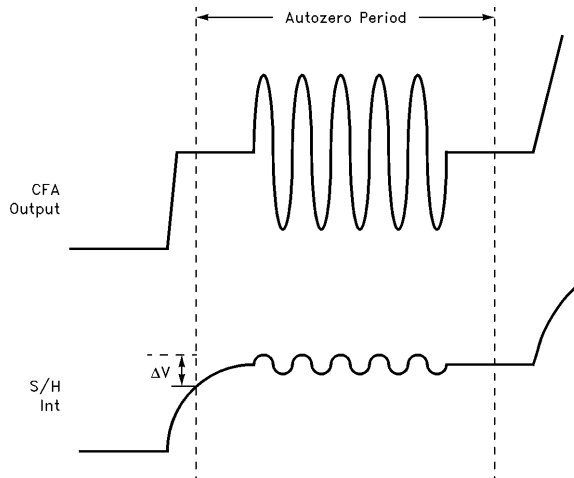

Figure 8. Lowpass Filter Delays Input to Sample and Hold

EL4093C

300 MHz DC-Restored Video Amplifier

Applications Information — Contd.

If the video does not contain any AC components during the autozero level (e.g. RGB video), then the above networks are not needed and the CFA output can be connected directly to the S/H input.

Power Dissipation

The EL4093 current feedback amplifier has an absolute maximum of ± 30 mA output current drive. This is slightly more than the current required to drive ± 2 V into 75Ω . To see how much the junction temperature is raised in this worst case, we refer to the equations below:

$$T_{JMAX} = T_{MAX} + (\theta_{JA} \cdot PD_{MAX})$$

where:

- T_{MAX} = Maximum Ambient Temperature
- θ_{JA} = Thermal Resistance of the Package
- PD_{MAX} = Maximum Power Dissipation of the CFA and S/H amplifier in the Package

PD_{MAX} for either the CFA or the S/H amplifier can be calculated as follows:

$$PD_{MAX} = (2 \cdot V_S \cdot I_{SMAX}) + (V_S - V_{OUTMAX}) \cdot (V_{OUTMAX}/R_L)$$

where:

- V_S = Supply Voltage
- I_{SMAX} = Maximum Supply Current of Amplifier
- V_{OUTMAX} = Maximum Output Voltage of Application
- R_L = Load Resistance

For the EL4093, the maximum supply current is 11.5 mA on $V_S = \pm 5$ V. Assume that in the worst case, the CFA output swings ± 2 V into 75Ω . Since the S/H has a current output, we assume that it is at maximum current swing (± 5.5 mA) but at a mid-rail output voltage (0V). With the above assumptions, PD_{MAX} for the EL4093 is 223 mW, and using the thermal resistance of a narrow SO package ($120^\circ\text{C}/\text{W}$), this yields a temperature increase of 27°C . Since the maximum ambient temperature is 85°C , the resulting junction temperature of 112°C is still below the maximum.

Please note that there is no short-circuit protection on the EL4093 CFA output, and hence the minimum short circuit current (60 mA) is greater than the absolute maximum output current. Maintaining the EL4093 in this state for more than a few seconds may cause the part to exceed T_{JMAX} , in addition to metal migration problems.

EL4093C

300 MHz DC-Restored Video Amplifier

General Disclaimer

Specifications contained in this data sheet are in effect as of the publication date shown. Elantec, Inc. reserves the right to make changes in the circuitry or specifications contained herein at any time without notice. Elantec, Inc. assumes no responsibility for the use of any circuits described herein and makes no representations that they are free from patent infringement.

élantec
HIGH PERFORMANCE ANALOG INTEGRATED CIRCUITS

Elantec, Inc.
1996 Tarob Court
Milpitas, CA 95035
Telephone: (408) 945-1323
(800) 333-6314
Fax: (408) 945-9305
European Office: 44-71-482-4596

WARNING — Life Support Policy

Elantec, Inc. products are not authorized for and should not be used within Life Support Systems without the specific written consent of Elantec, Inc. Life Support systems are equipment intended to support or sustain life and whose failure to perform when properly used in accordance with instructions provided can be reasonably expected to result in significant personal injury or death. Users contemplating application of Elantec, Inc. products in Life Support Systems are requested to contact Elantec, Inc. factory headquarters to establish suitable terms & conditions for these applications. Elantec, Inc.'s warranty is limited to replacement of defective components and does not cover injury to persons or property or other consequential damages.