

Features

- 12MHz -3dB Bandwidth
- Unity gain buffer
- Supply voltage = 4.5V to 16.5V
- Low supply current (per buffer) = 500 μ A
- High slew rate = 10V/ μ s
- Rail to Rail operation
- “Mini” SO Package (MSOP)

Applications

- TFT-LCD Drive Circuits
- Electronics Notebooks
- Electronics Games
- Personal Communication Devices
- Personal Digital Assistants (PDA)
- Portable Instrumentation
- Wireless LANs
- Office Automation
- Active Filters
- ADC/DAC Buffer

Ordering Information

Part No.	Temp. Range	Package	Outline #
EL5421CY	-40°C to +85°C	10-Pin MSOP	MDP0043

General Description

The EL5421C is a quad, low power, high voltage rail-to-rail input-output buffer. Operating on supplies ranging from 5V to 15V, while consuming only 500 μ A per channel, the EL5421C has a bandwidth of 12MHz (-3dB). The EL5421C also provides rail-to-rail input and output ability, giving the maximum dynamic range at any supply voltage.

The EL5421C also features fast slewing and settling times, as well as a high output drive capability of 30mA (sink and source). These features make the EL5421C ideal for use as voltage reference buffers in Thin Film Transistor Liquid Crystal Displays (TFT-LCD). Other applications include battery power, portable devices and anywhere low power consumption is important.

The EL5421C is available in a space saving 10-Pin MSOP package and operates over a temperature range of -40°C to +85°C.

Connection Diagram

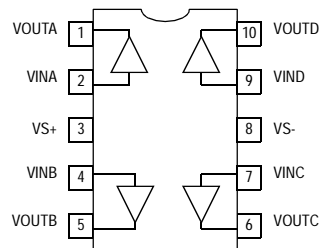

EL 5421C (MSOP 10)

EL5421C

Quad 12MHz Rail-to-Rail Input-Output Buffer

Absolute Maximum Ratings (T_A = 25°C)

Values beyond absolute maximum ratings can cause the device to be prematurely damaged. Absolute maximum ratings are stress ratings only and functional device operation is not implied

Supply Voltage between V _{S+} and V _{S-}	+18V
Input Voltage	V _{S-} - 0.5V, V _{S+} +0.5V
Maximum Continuous Output Current	30mA

Maximum Die Temperature	+125°C
Storage Temperature	-65°C to +150°C
Operating Temperature	-40°C to +85°C
Power Dissipation	See Curves
ESD Voltage	2kV

Important Note:

All parameters having Min/Max specifications are guaranteed. Typ values are for information purposes only. Unless otherwise noted, all tests are at the specified temperature and are pulsed tests, therefore: T_J = T_C = T_A

Electrical Characteristics

V_{S+} = +5V, V_{S-} = -5V, R_L = 10kΩ and C_L = 10pF to 0V, T_A = 25°C unless otherwise specified.

Parameter	Description	Condition	Min	Typ	Max	Unit
Input Characteristics						
V _{OS}	Input Offset Voltage	V _{CM} = 0V		2	12	mV
TCV _{OS}	Average Offset Voltage Drift	[1]		5		μV/°C
I _B	Input Bias Current	V _{CM} = 0V		2	50	nA
R _{IN}	Input Impedance			1		GΩ
C _{IN}	Input Capacitance			1.35		pF
A _V	Voltage Gain	-4.5V ≤ V _{OUT} ≤ 4.5V	0.995		1.005	V/V
Output Characteristics						
V _{OL}	Output Swing Low	I _L = -5mA		-4.92	-4.85	V
V _{OH}	Output Swing High	I _L = 5mA	4.85	4.92		V
I _{SC}	Short Circuit Current	Short to GND [2]	±80	±120		mA
Power Supply Performance						
PSRR	Power Supply Rejection Ratio	V _S is moved from ±2.25V to ±7.75V	60	80		dB
I _S	Supply Current (Per Buffer)	No Load		500	750	μA
Dynamic Performance						
SR	Slew Rate [3]	-4.0V ≤ V _{OUT} ≤ 4.0V, 20% to 80%	7	10		V/μs
t _s	Settling to +0.1%	V _O = 2V Step		500		ns
BW	-3dB Bandwidth	R _L = 10kΩ, C _L = 10pF		12		MHz
CS	Channel Separation	f = 5MHz		75		dB

1. Measured over the operating temperature range
2. Parameter is guaranteed (but not test) by design and characterization data
3. Slew rate is measured on rising and falling edges

Electrical Characteristics

$V_{S+} = +5V$, $V_{S-} = 0V$, $R_L = 10k\Omega$ and $C_L = 10pF$ to 2.5V, $T_A = 25^\circ C$ unless otherwise specified.

Parameter	Description	Condition	Min	Typ	Max	Unit
Input Characteristics						
V_{OS}	Input Offset Voltage	$V_{CM} = 2.5V$		2	10	mV
TCV_{OS}	Average Offset Voltage Drift	[1]		5		$\mu V/^\circ C$
I_B	Input Bias Current	$V_{CM} = 2.5V$		2	50	nA
R_{IN}	Input Impedance			1		$G\Omega$
C_{IN}	Input Capacitance			1.35		pF
A_V	Voltage Gain	$0.5 \leq V_{OUT} \leq 4.5V$	0.995		1.005	V/V
Output Characteristics						
V_{OL}	Output Swing Low	$I_L = -5mA$		80	150	mV
V_{OH}	Output Swing High	$I_L = 5mA$	4.85	4.92		V
I_{SC}	Short Circuit Current	Short to GND [2]	± 80	± 120		mA
Power Supply Performance						
PSRR	Power Supply Rejection Ratio	V_S is moved from 4.5V to 15.5V	60	80		dB
I_S	Supply Current (Per Buffer)	No Load		500	750	μA
Dynamic Performance						
SR	Slew Rate [3]	$1V \leq V_{OUT} \leq 4V$, 20% to 80%	7	10		$V/\mu s$
t_s	Settling to +0.1%	$V_O = 2V$ Step		500		ns
BW	-3dB Bandwidth	$R_L = 10 k\Omega$, $C_L = 10pF$		12		MHz
CS	Channel Separation	$f = 5MHz$		75		dB

1. Measured over the operating temperature range
2. Parameter is guaranteed (but not test) by design and characterization data
3. Slew rate is measured on rising and falling edges

EL5421C

Quad 12MHz Rail-to-Rail Input-Output Buffer

Electrical Characteristics

$V_{S+} = +15V$, $V_{S-} = 0V$, $R_L = 10k\Omega$ and $C_L = 10pF$ to 7.5V, $T_A = 25^\circ C$ unless otherwise specified.

Parameter	Description	Condition	Min	Typ	Max	Unit
Input Characteristics						
V_{OS}	Input Offset Voltage	$V_{CM} = 7.5V$		2	14	mV
TCV_{OS}	Average Offset Voltage Drift	[1]		5		$\mu V/^\circ C$
I_B	Input Bias Current	$V_{CM} = 7.5V$		2	50	nA
R_{IN}	Input Impedance			1		$G\Omega$
C_{IN}	Input Capacitance			1.35		pF
A_V	Voltage Gain	$0.5 \leq V_{OUT} \leq 14.5V$	0.995		1.005	V/V
Output Characteristics						
V_{OL}	Output Swing Low	$I_L = -5mA$		80	150	mV
V_{OH}	Output Swing High	$I_L = 5mA$	14.85	14.92		V
I_{SC}	Short Circuit Current	Short to GND [2]	± 80	± 120		mA
Power Supply Performance						
PSRR	Power Supply Rejection Ratio	V_S is moved from 4.5V to 15.5V	60	80		dB
I_S	Supply Current (Per Buffer)	No Load		500	750	μA
Dynamic Performance						
SR	Slew Rate [3]	$1V \leq V_{OUT} \leq 14V$, 20% to 80%	7	10		$V/\mu s$
t_s	Settling to +0.1%	$V_O = 2V$ Step		500		ns
BW	-3dB Bandwidth	$R_L = 10 k\Omega$, $C_L = 10pF$		12		MHz
CS	Channel Separation	$f = 5MHz$		75		dB

1. Measured over the operating temperature range
2. Parameter is guaranteed (but not test) by design and characterization data
3. Slew rate is measured on rising and falling edges

Typical Performance Curves

Input Offset Voltage Distribution

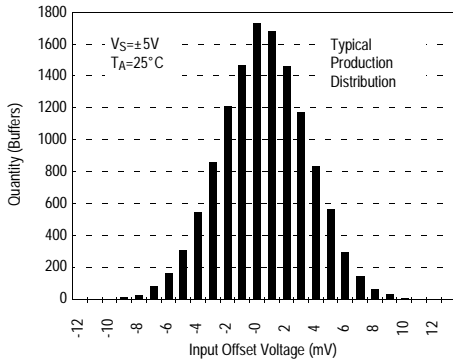

Input Offset Voltage Drift

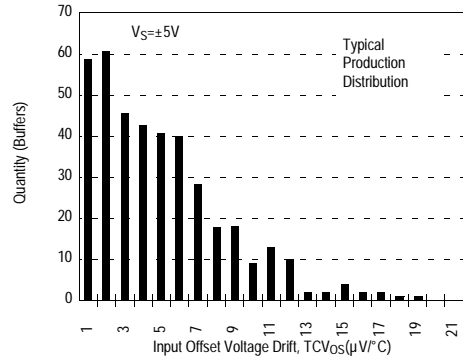

Input Offset Voltage vs Temperature

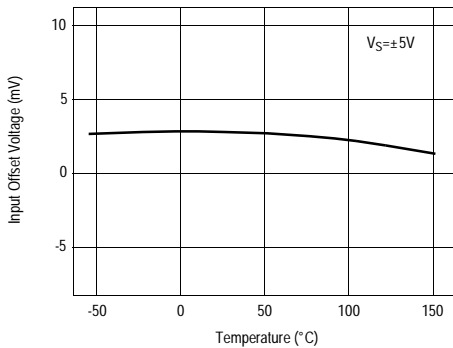

Input Bias Current vs Temperature

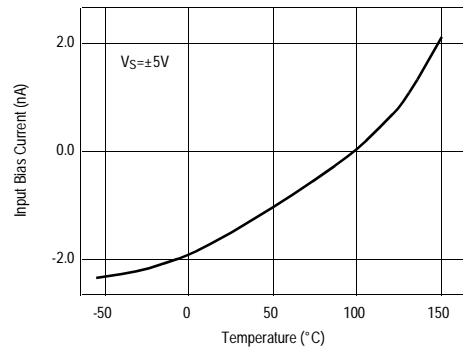

Output High Voltage vs Temperature

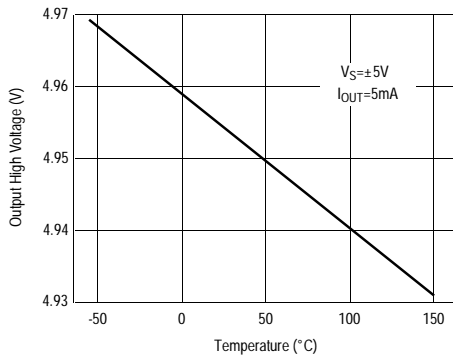

Output Low Voltage vs Temperature

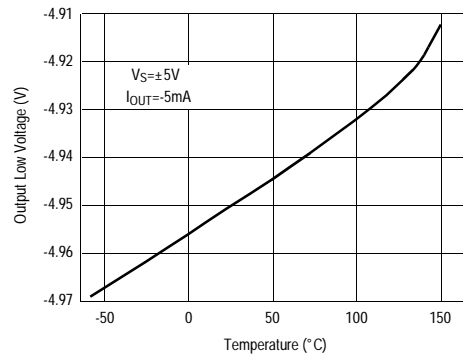

EL5421C

Quad 12MHz Rail-to-Rail Input-Output Buffer

Voltage Gain vs Temperature

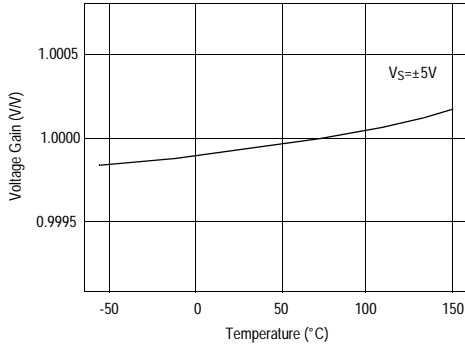

Slew Rate vs Temperature

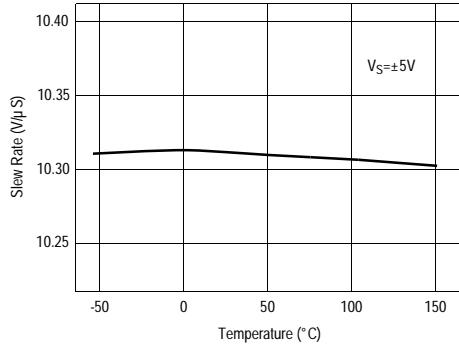

Supply Current per Channel vs Temperature

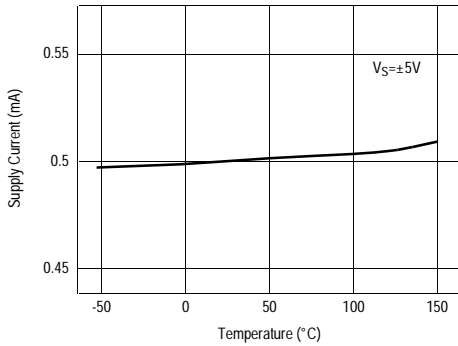

Supply Current per Channel vs Supply Voltage

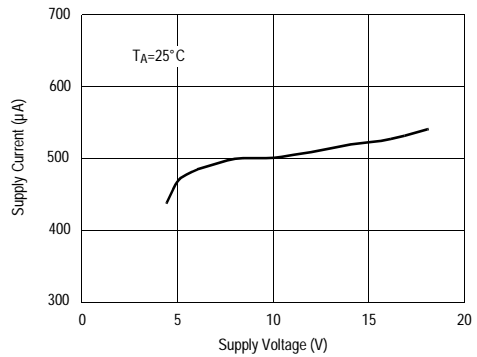

Frequency Response for Various R_L

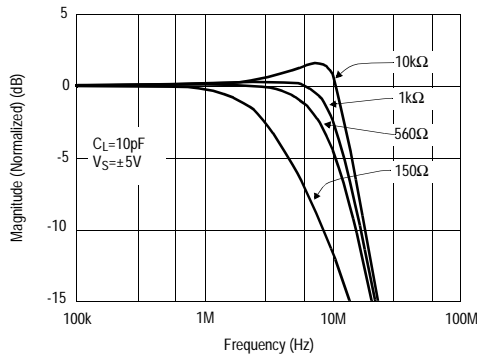

Frequency Response for Various C_L

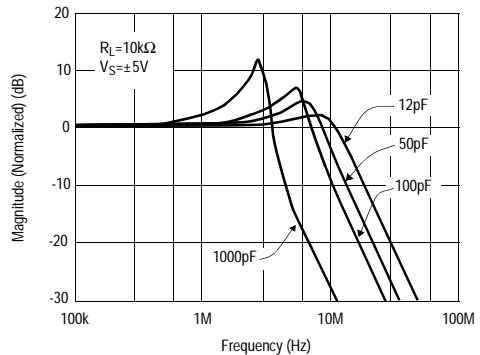

EL5421C

Quad 12MHz Rail-to-Rail Input-Output Buffer

Output Impedance vs Frequency

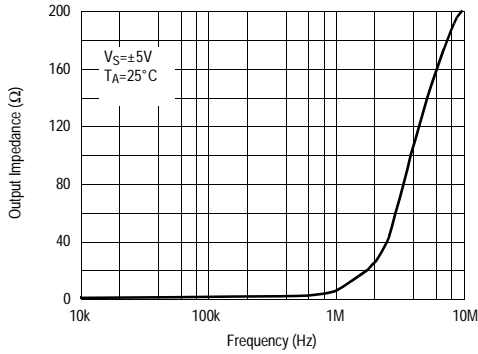

Maximum Output Swing vs Frequency

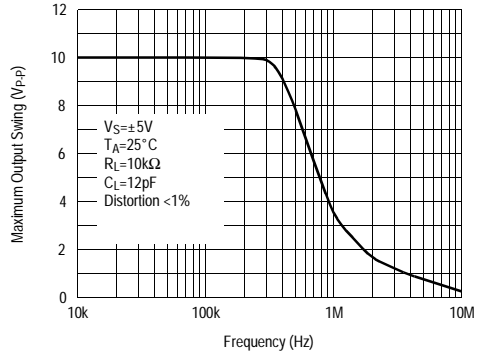

PSRR vs Frequency

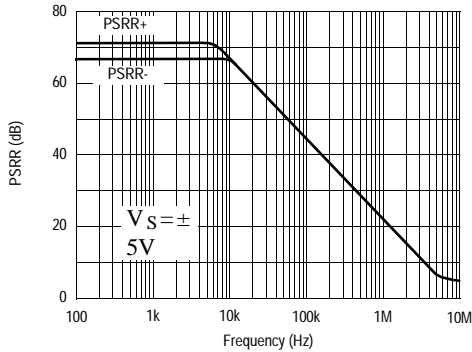

Input Voltage Noise Spectral Density vs Frequency

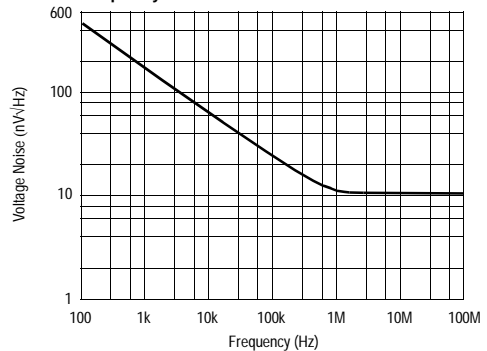

Total Harmonic Distortion + Noise vs Frequency

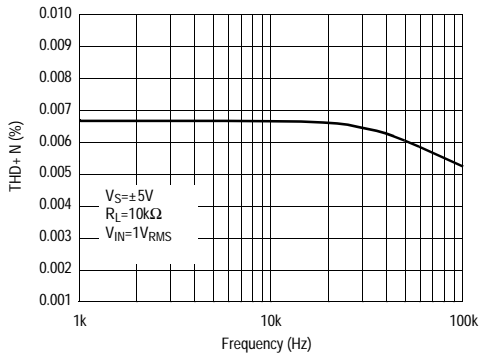

Channel Separation vs Frequency Response

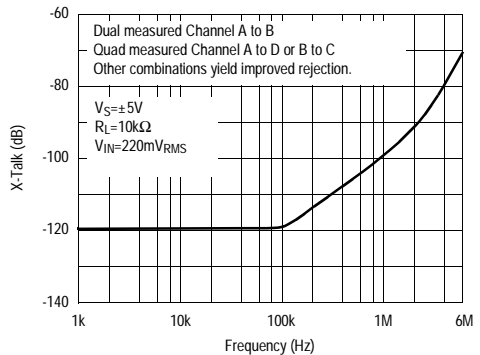

EL5421C

Quad 12MHz Rail-to-Rail Input-Output Buffer

Small-Signal Overshoot vs Load Capacitance

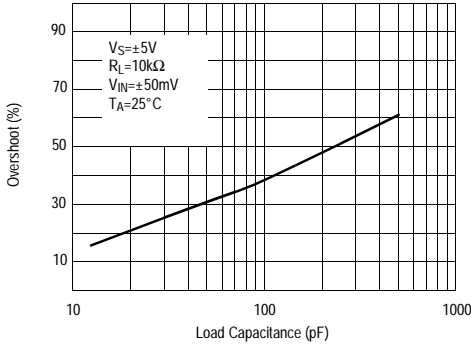

Settling Time vs Step Size

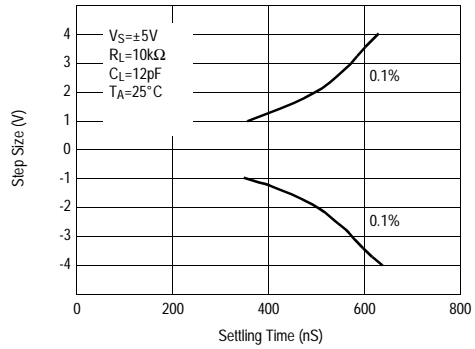

Large Signal Transient Response

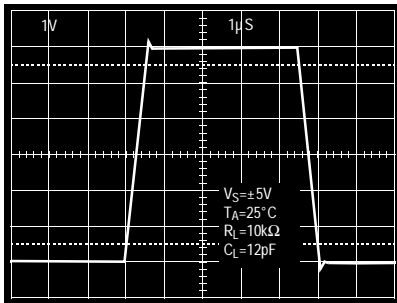

Small Signal Transient Response

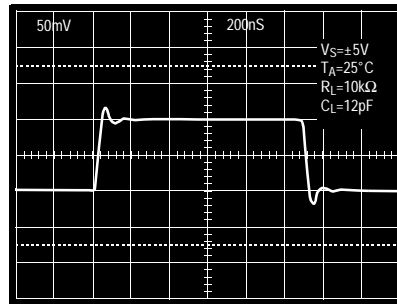

Pin Description

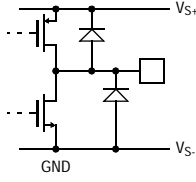
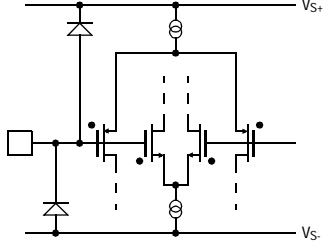
EL5421C	Name	Function	Equivalent Circuit
1	V _{OUTA}	Buffer A Output	 <p style="text-align: center;">Circuit 1</p>
2	V _{INA}	Buffer A Input	 <p style="text-align: center;">Circuit 2</p>
3	V _{S+}	Positive Power Supply	
4	V _{INB}	Buffer B Input	(Reference Circuit 1)
5	V _{OUTB}	Buffer B Output	(Reference Circuit 2)
6	V _{OUTC}	Buffer C Output	(Reference Circuit 2)
7	V _{INC}	Buffer C Input	(Reference Circuit 1)
8	V _{S-}	Negative Power Supply	
9	V _{IND}	Buffer D Input	(Reference Circuit 2)
10	V _{OUTD}	Buffer D Output	(Reference Circuit 1)

EL5421C

Quad 12MHz Rail-to-Rail Input-Output Buffer

Applications Information

Product Description

The EL5421C unity gain buffer is fabricated using a high voltage CMOS process. It exhibits Rail-to-Rail input and output capability, and has low power consumption (500 μ A per buffer). These features make the EL5421C ideal for a wide range of general-purpose applications. When driving a load of 10k Ω and 12pF, the EL5421C has a -3dB bandwidth of 12 MHz and exhibits 10V/ μ S slew rate.

Operating Voltage, Input, and Output

The EL5421C is specified with a single nominal supply voltage from 5V to 15V or a split supply with its total range from 5V to 15V. Correct operation is guaranteed for a supply range of 4.5V to 16.5V. Most EL5421C specifications are stable over both the full supply range and operating temperatures of -40 $^{\circ}$ C to +85 $^{\circ}$ C. Parameter variations with operating voltage and/or temperature are shown in the typical performance curves.

The output swings of the EL5421C typically extend to within 80mV of positive and negative supply rails with load currents of 5mA. Decreasing load currents will extend the output voltage range even closer to the supply rails. Figure 1 shows the input and output waveforms for the device. Operation is from \pm 5V supply with a 10k Ω load connected to GND. The input is a 10Vp-p sinusoid. The output voltage is approximately 9.985 V_{p-p}.

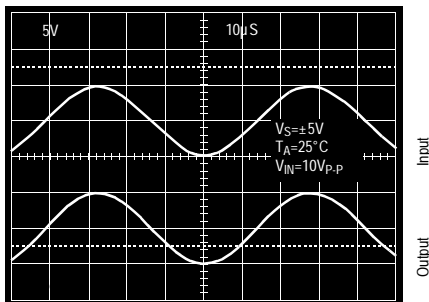

Figure 1. Operation with Rail-to-Rail Input and Output

Short Circuit Current Limit

The EL5421C will limit the short circuit current to \pm 120mA if the output is directly shorted to the positive or the negative supply. If an output is shorted indefinitely, the power dissipation could easily increase such that the device may be damaged. Maximum reliability is maintained if the output continuous current never exceeds \pm 30 mA. This limit is set by the design of the internal metal interconnects.

Output Phase Reversal

The EL5421C is immune to phase reversal as long as the input voltage is limited from $V_{S-} - 0.5V$ to $V_{S+} + 0.5V$. Figure 2 shows a photo of the output of the device with the input voltage driven beyond the supply rails. Although the device's output will not change phase, the input's overvoltage should be avoided. If an input voltage exceeds supply voltage by more than 0.6V, electrostatic protection diodes placed in the input stage of the device begin to conduct and overvoltage damage could occur.

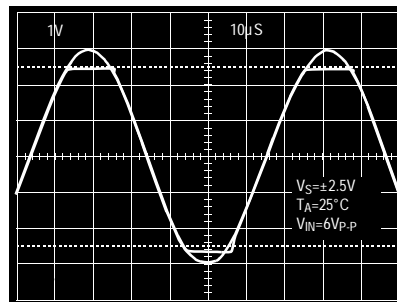

Figure 2. Operation with Beyond-the-Rails Input

Power Dissipation

With the high-output drive capability of the EL5421C buffer, it is possible to exceed the 125 $^{\circ}$ C 'absolute-maximum junction temperature' under certain load current conditions. Therefore, it is important to calculate the

maximum junction temperature for the application to determine if load conditions need to be modified for the buffer to remain in the safe operating area.

The maximum power dissipation allowed in a package is determined according to:

$$P_{D_{MAX}} = \frac{T_{J_{MAX}} - T_{A_{MAX}}}{\theta_{JA}}$$

where:

$T_{J_{MAX}}$ = Maximum Junction Temperature

$T_{A_{MAX}}$ = Maximum Ambient Temperature

θ_{JA} = Thermal Resistance of the Package

$P_{D_{MAX}}$ = Maximum Power Dissipation in the Package

The maximum power dissipation actually produced by an IC is the total quiescent supply current times the total power supply voltage, plus the power in the IC due to the loads, or:

$$P_{D_{MAX}} = \sum i[V_S \times I_{S_{MAX}} + (V_S - V_{OUTi}) \times I_{LOADi}]$$

when sourcing, and:

$$P_{D_{MAX}} = \sum i[V_S \times I_{S_{MAX}} + (V_{OUTi} - V_S) \times I_{LOADi}]$$

when sinking.

Where:

$i = 1$ to 4 for Quad

V_S = Total Supply Voltage

$I_{S_{MAX}}$ = Maximum Supply Current Per Channel

V_{OUTi} = Maximum Output Voltage of the Application

I_{LOADi} = Load current

If we set the two $P_{D_{MAX}}$ equations equal to each other, we can solve for R_{LOADi} to avoid device overheat. Figure 3 and Figure 4 provide a convenient way to see if the device will overheat. The maximum safe power dissipation can be found graphically, based on the package type and the ambient temperature. By using the previous

equation, it is a simple matter to see if $P_{D_{MAX}}$ exceeds the device's power derating curves. To ensure proper operation, it is important to observe the recommended derating curves shown in Figure 3 and Figure 4.

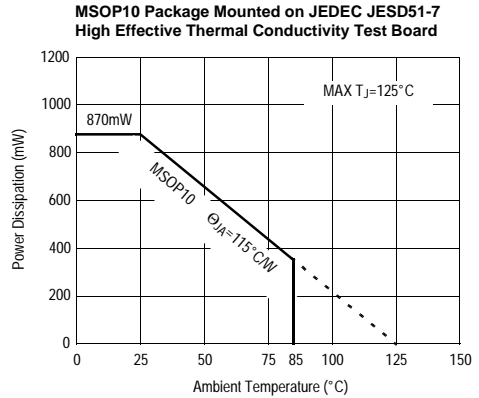

Figure 3. Package Power Dissipation vs Ambient Temperature

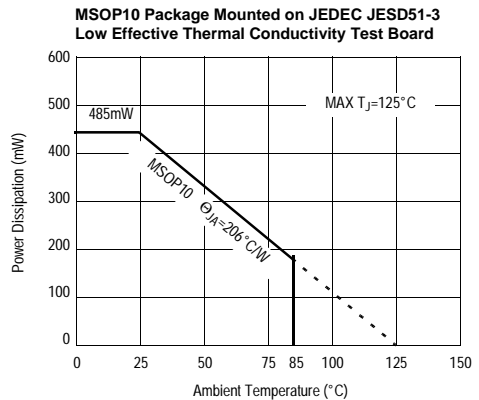

Figure 4. Package Power Dissipation vs Ambient Temperature

Unused Buffers

It is recommended that any unused buffer have the input tied to the ground plane.

EL5421C

Quad 12MHz Rail-to-Rail Input-Output Buffer

Driving Capacitive Loads

The EL5421C can drive a wide range of capacitive loads. As load capacitance increases, however, the -3dB bandwidth of the device will decrease and the peaking increase. The buffers drive 10pF loads in parallel with 10 k Ω with just 1.5dB of peaking, and 100pF with 6.4dB of peaking. If less peaking is desired in these applications, a small series resistor (usually between 5 Ω and 50 Ω) can be placed in series with the output. However, this will obviously reduce the gain slightly. Another method of reducing peaking is to add a "snubber" circuit at the output. A snubber is a shunt load consisting of a resistor in series with a capacitor. Values of 150 Ω and 10nF are typical. The advantage of a snubber is that it does not draw any DC load current or reduce the gain

Power Supply Bypassing and Printed Circuit Board Layout

The EL5421C can provide gain at high frequency. As with any high-frequency device, good printed circuit board layout is necessary for optimum performance. Ground plane construction is highly recommended, lead lengths should be as short as possible and the power supply pins must be well bypassed to reduce the risk of oscillation. For normal single supply operation, where the V_{S-} pin is connected to ground, a 0.1 μ F ceramic capacitor should be placed from V_{S+} to pin to V_{S-} pin. A 4.7 μ F tantalum capacitor should then be connected in parallel, placed in the region of the buffer. One 4.7 μ F capacitor may be used for multiple devices. This same capacitor combination should be placed at each supply pin to ground if split supplies are to be used.

EL5421C

Quad 12MHz Rail-to-Rail Input-Output Buffer

General Disclaimer

Specifications contained in this data sheet are in effect as of the publication date shown. Elantec, Inc. reserves the right to make changes in the circuitry or specifications contained herein at any time without notice. Elantec, Inc. assumes no responsibility for the use of any circuits described herein and makes no representations that they are free from patent infringement.

élantec

HIGH PERFORMANCE ANALOG INTEGRATED CIRCUITS

Elantec Semiconductor, Inc.

675 Trade Zone Blvd.

Milpitas, CA 95035

Telephone: (408) 945-1323

(888) ELANTEC

Fax: (408) 945-9305

European Office: +44-118-977-6080

Japan Technical Center: +81-45-682-5820

WARNING - Life Support Policy

Elantec, Inc. products are not authorized for and should not be used within Life Support Systems without the specific written consent of Elantec, Inc. Life Support systems are equipment intended to support or sustain life and whose failure to perform when properly used in accordance with instructions provided can be reasonably expected to result in significant personal injury or death. Users contemplating application of Elantec, Inc. Products in Life Support Systems are requested to contact Elantec, Inc. factory headquarters to establish suitable terms & conditions for these applications. Elantec, Inc.'s warranty is limited to replacement of defective components and does not cover injury to persons or property or other consequential damages.