

Dual Channel, High Speed, High Current Line Driver w/3-State

The EL7232 3-state drivers are particularly well suited for ATE and microprocessor based applications. The low quiescent power dissipation makes this part attractive in battery applications. The 2A peak drive capability, makes the EL7232 an excellent choice when driving high speed capacitive lines, as well. The input circuitry provides level shifting from TTL levels to the supply rails. The EL7232 is available in 8-pin PDIP and 8-lead SO packages.

Ordering Information

PART NUMBER	PACKAGE	TAPE & REEL	PKG. DWG. #
EL7232CN	8-Pin PDIP	-	MDP0031
EL7232CS	8-Pin SO	-	MDP0027
EL7232CS-T7	8-Pin SO	7"	MDP0027
EL7232CS-T13	8-Pin SO	13"	MDP0027
EL7232CSZ (See Note)	8-Pin SO (Pb-free)	-	MDP0027
EL7232CSZ-T7 (See Note)	8-Pin SO (Pb-free)	7"	MDP0027
EL7232CSZ-T13 (See Note)	8-Pin SO (Pb-free)	13"	MDP0027

NOTE: Intersil Pb-free products employ special Pb-free material sets; molding compounds/die attach materials and 100% matte tin plate termination finish, which are RoHS compliant and compatible with both SnPb and Pb-free soldering operations. Intersil Pb-free products are MSL classified at Pb-free peak reflow temperatures that meet or exceed the Pb-free requirements of IPC/JEDEC J STD-020.

Features

- 3-State output
- 3V and 5V input compatible
- Clocking speeds up to 10MHz
- 20ns Switching/delay time
- 2A Peak drive
- Low, matched output impedance—5Ω
- Low quiescent current — 2.5mA
- Wide operating voltage — 4.5V-16V
- Pb-Free available (RoHS compliant)

Applications

- Parallel bus line drivers
- EPROM and PROM programming
- Motor controls
- Charge pumps
- Sampling circuits
- Pin drivers
- Bridge circuits

Pinout

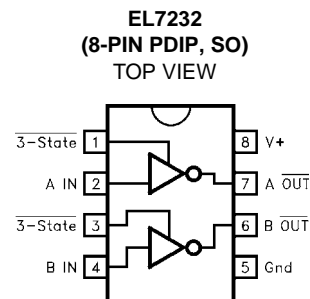

Manufactured under U.S. Patent Nos. 5,334,883, #5,341,047

Truth Table

3-STATE	INPUT	OUTPUT
1	0	1
1	1	0
0	0	Open
0	1	Open

Absolute Maximum Ratings ($T_A = 25^\circ\text{C}$)

Supply (V+ to Gnd)	16.5V	Operating Junction Temperature	125°C
Input Pins	-0.3V to +0.3V above V+	Power Dissipation	
Combined Peak Output Current4A	SOIC570mW
Storage Temperature Range	-65°C to +150°C	PDIP1050mW
Ambient Operating Temperature	-40°C to +85°C		

CAUTION: Stresses above those listed in "Absolute Maximum Ratings" may cause permanent damage to the device. This is a stress only rating and operation of the device at these or any other conditions above those indicated in the operational sections of this specification is not implied.

IMPORTANT NOTE: All parameters having Min/Max specifications are guaranteed. Typical values are for information purposes only. Unless otherwise noted, all tests are at the specified temperature and are pulsed tests, therefore: $T_J = T_C = T_A$

DC Electrical Specifications $T_A = 25^\circ\text{C}$, $V = 15\text{V}$ unless otherwise specified

PARAMETER	DESCRIPTION	TEST CONDITIONS	MIN	TYP	MAX	UNITS
INPUT						
V_{IH}	Logic "1" Input Voltage		2.4			V
I_{IH}	Logic "1" Input Current	@V+		0.1	10	μA
V_{IL}	Logic "0" Input Voltage				0.8	V
I_{IL}	Logic "0" Input Current	@0V		0.1	10	μA
V_{HVS}	Input Hysteresis			0.3		V
OUTPUT						
R_{OH}	Pull-Up Resistance	$I_{OUT} = -100\text{ mA}$		3	6	Ω
R_{OL}	Pull-Down Resistance	$I_{OUT} = +100\text{ mA}$		4	6	Ω
I_{OFF}	3-State Output Leakage	$V_{OUT} = V+$ $V_{OUT} = 0V$	0.2		10	μA
I_{PK}	Peak Output Current	Source Sink		2.0 2.0		A
I_{DC}	Continuous Output Current	Source/Sink	100			mA
POWER SUPPLY						
I_S	Power Supply Current	Inputs High		1	2.5	mA
V_S	Operating Voltage		4.5		16	V

AC Electrical Specifications $T_A = 25^\circ\text{C}$, $V = 15\text{V}$ unless otherwise specified

PARAMETER	DESCRIPTION	TEST CONDITIONS	MIN	TYP	MAX	UNITS
SWITCHING CHARACTERISTICS						
t_R	Rise Time	$C_L = 500\text{pF}$ $C_L = 1000\text{pF}$		7.5 10		ns
t_F	Fall Time	$C_L = 500\text{pF}$ $C_L = 1000\text{pF}$		10 13	20	ns
t_{D-ON}	Turn-On Delay Time			18	25	ns
t_{D-OFF}	Turn-Off Delay Time			20	25	ns

Timing Table

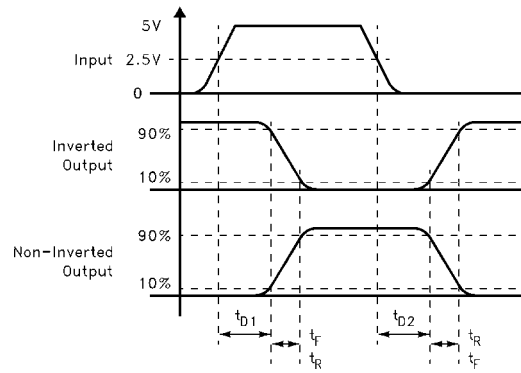

Standard Test Configuration

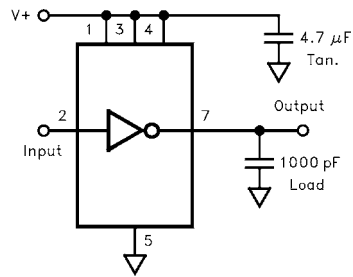

Simplified Schematic

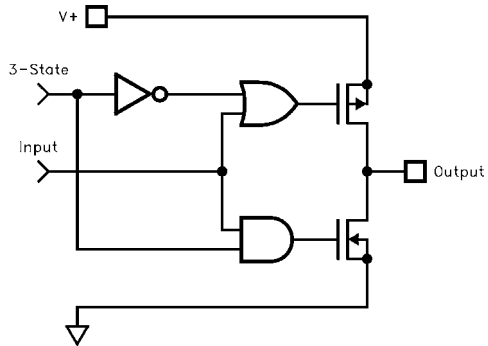

Typical Performance Curves

Max Power/Derating Curves

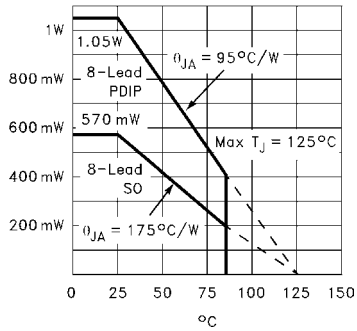

Switch Threshold vs Supply Voltage

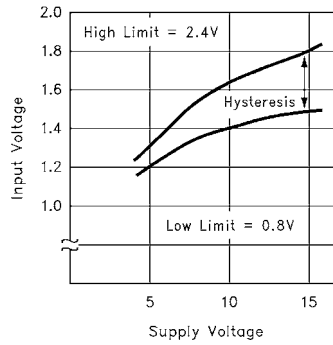

Input Current vs Voltage

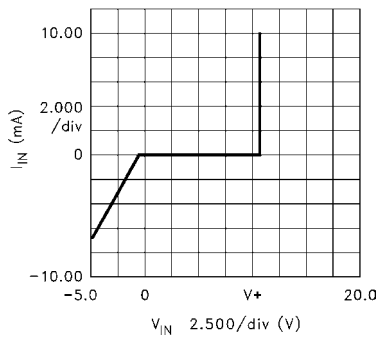

Peak Drive vs Supply Voltage

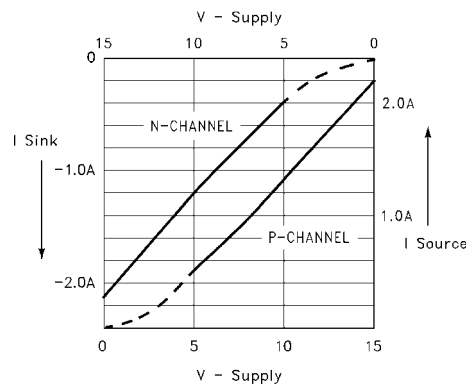

Quiescent Supply Current

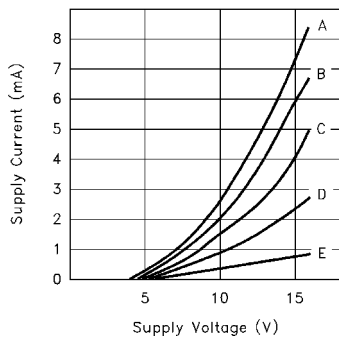

CASE:

A	ALL INPUTS GND
B	3 INPUTS GND
C	2 INPUTS GND
D	1 INPUTS GND
E	ALL INPUTS V+

"ON" Resistance vs Supply Voltage

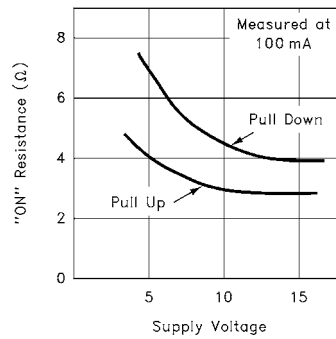

Typical Performance Curves (Continued)

Average Supply Current vs Voltage and Frequency

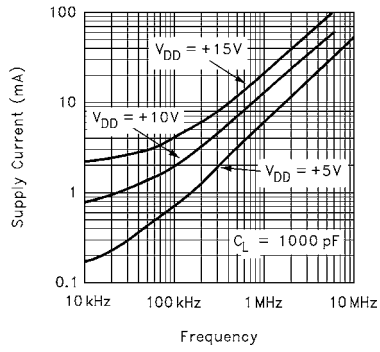

Average Supply Current vs Capacitive Load

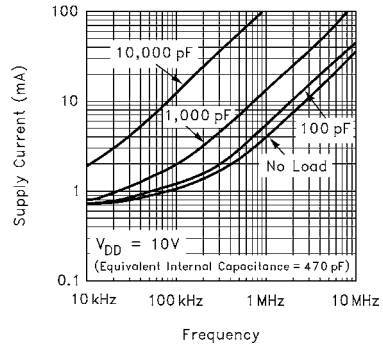

Rise/Fall Time vs Load

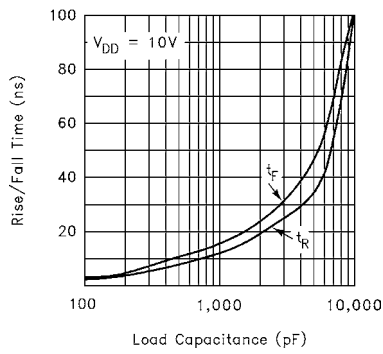

Rise/Fall Time vs Supply Voltage

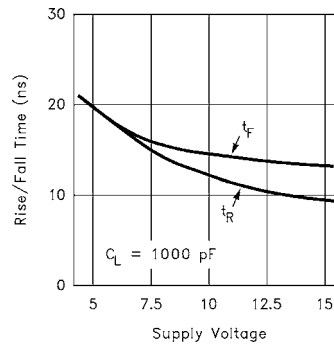

Typical Performance Curves (Continued)

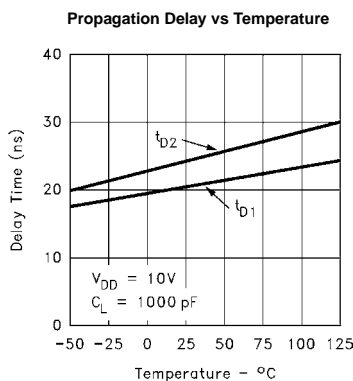
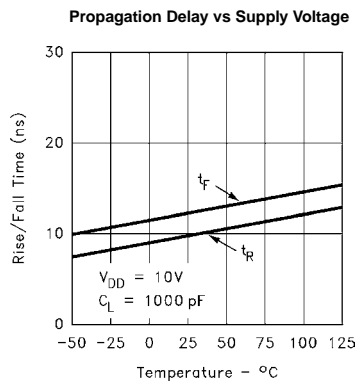
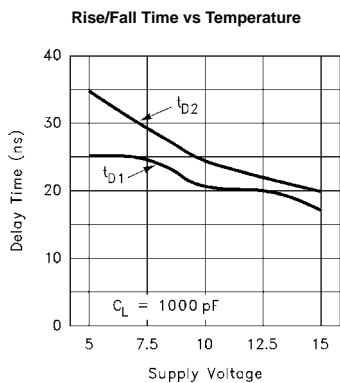

All Intersil U.S. products are manufactured, assembled and tested utilizing ISO9000 quality systems. Intersil Corporation's quality certifications can be viewed at www.intersil.com/design/quality

Intersil products are sold by description only. Intersil Corporation reserves the right to make changes in circuit design, software and/or specifications at any time without notice. Accordingly, the reader is cautioned to verify that data sheets are current before placing orders. Information furnished by Intersil is believed to be accurate and reliable. However, no responsibility is assumed by Intersil or its subsidiaries for its use; nor for any infringements of patents or other rights of third parties which may result from its use. No license is granted by implication or otherwise under any patent or patent rights of Intersil or its subsidiaries.

For information regarding Intersil Corporation and its products, see www.intersil.com