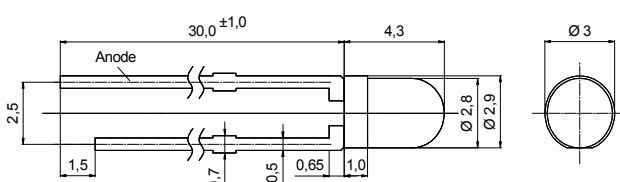

Radiation	Type	Technology	Case
Blue	Standard	InGaN/Al ₂ O ₃	3 mm plastic lens

	Description
	<p>High-power, high-speed blue LED with lens, standard 3 mm package allows compact design, housing without standoff leads</p> <p>Note: Special packages with standoff available on request</p>
	Applications
	Optical communications, safety equipment, automation

Maximum Ratings

T_{amb} = 25°C, unless otherwise specified

Parameter	Test conditions	Symbol	Value	Unit
Forward current (DC)		I _F	30	mA
Peak forward current	(t _p ≤ 50 μs, t _p /T = 1/2)	I _{FM}	300	mA
Power dissipation		P _D	120	mW
Operating temperature range		T _{amb}	-20 to +80	°C
Storage temperature range		T _{stg}	-30 to +100	°C
Soldering temperature	t ≤ 5 s, 3 mm from case	T _{Sd}	260	°C

Optical and Electrical Characteristics

T_{amb} = 25°C, unless otherwise specified

Parameter	Test conditions	Symbol	Min	Typ	Max	Unit
Forward voltage	I _F = 20 mA	V _F		3.5	4	V
Reverse voltage	I _R = 100 μA	V _R	5			V
Luminous intensity	I _F = 20 mA	I _v		300		mcd
Peak wavelength	I _F = 20 mA	λ _p		468		nm
Spectral bandwidth at 50%	I _F = 20 mA	Δλ _{0.5}		35		nm
Viewing angle	I _F = 20 mA	φ		80		deg.
Switching time	I _F = 20 mA	t _r , t _f		40		ns

*measured after 30s current flow

Note: All measurements carried out on *EPIGAP* equipment

We reserve the right to make changes to improve technical design and may do so without further notice.
Parameters can vary in different applications. All operating parameters must be validated for each customer application by the customer.

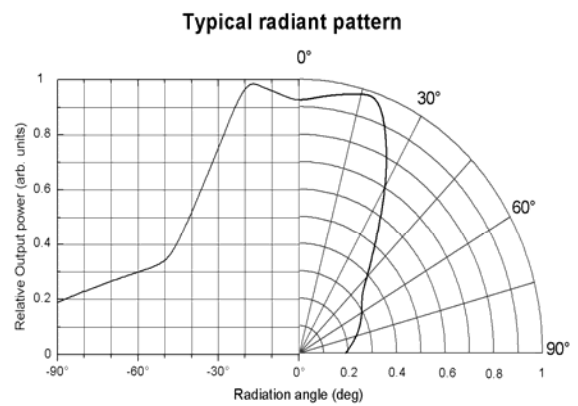
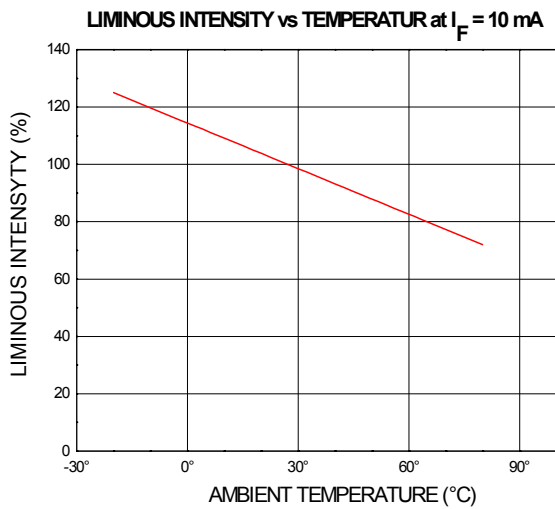
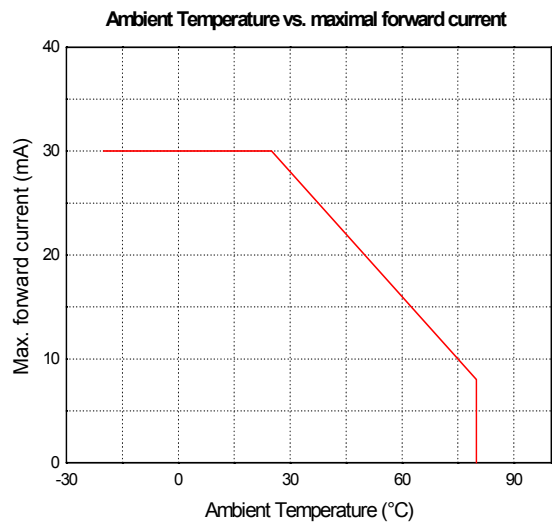
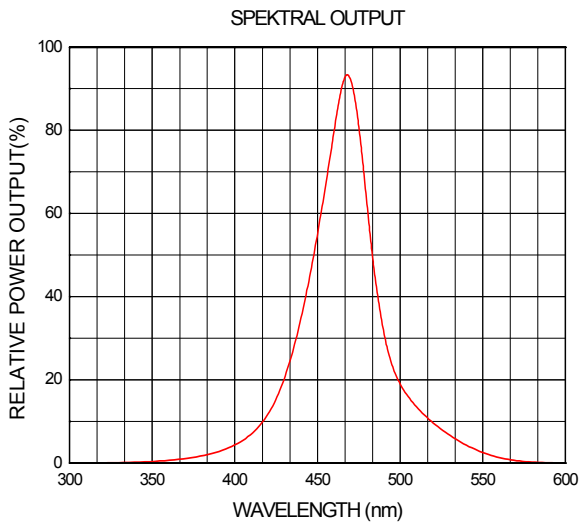
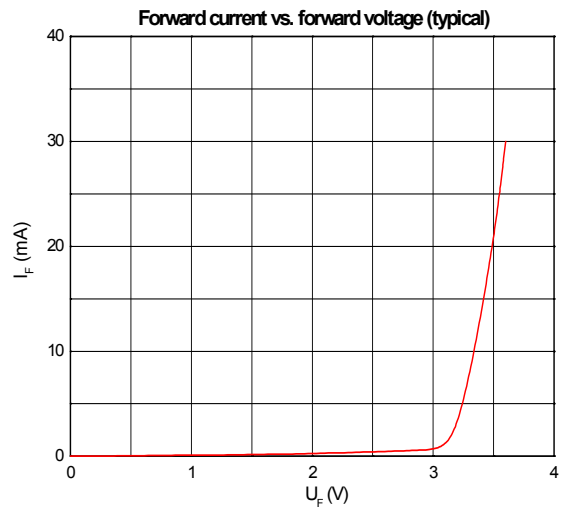
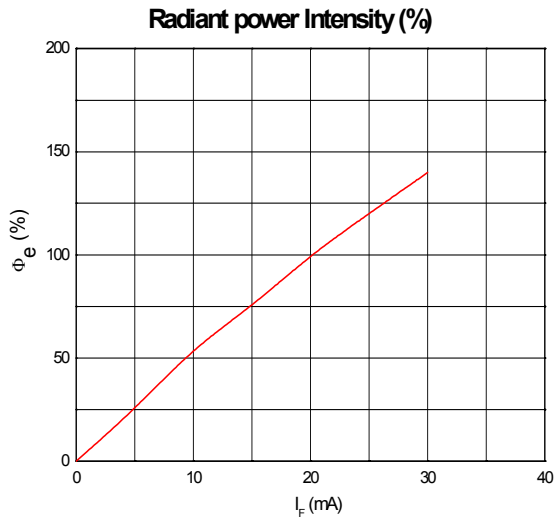

We reserve the right to make changes to improve technical design and may do so without further notice. Parameters can vary in different applications. All operating parameters must be validated for each customer application by the customer.