

# ELM88xxxxA CMOS 300mA LDO Voltage regulator

## ■ General description

ELM88xxxxA is high current and low dropout(LOD) CMOS fixed voltage regulator. There are 2 types of CE selection for ELM88 series: non-chip enable function and “H” active. Thermal shutdown protective function and short circuit current limiter are included in the IC. The standard output voltages are 1.2V, 1.8V, 2.5V, 3.0V, 3.3V, 5.0V; ELM88 series can also be designed as semi-customed IC within the range of 0.8V~5.0V by 0.1V step.

## ■ Features

- Output voltage range : 0.8V~5.0V (by 0.1V)
- Output current : 300mA
- Stand by current consumption : Typ. 0.1μA
- Input stability : Typ. 0.02%/V ( $I_{out}=40mA$ )
- Load stability : Typ. 5mV ( $1mA \leq I_{out} \leq 100mA$ )
- Accuracy of output voltage :  $\pm 2.0\%$  ( $V_{out} > 1.5V$ )  
 $\pm 30mV$  ( $V_{out} \leq 1.5V$ )
- Input-output voltage difference : Typ. 350mV ( $V_{out}=3.0V, I_{out}=300mA$ )
- Short circuit current limiter : Typ. 40mA ( $V_{out}=0V$ )
- Thermal shutdown protection : Typ. 165°C
- Chip enable pin : “H” active (ELM88xx3xA)
- Package : SOT-89, SOT-89-5,  
SOT-23, SOT-25,  
SC-70(SOT-323), SC-70-5

## ■ Application

- Battery operated devices
- Camera and Video recorders
- Reference voltage source
- Portable electronics

## ■ Maximum absolute ratings

Parameter	Symbol	Limit	Unit
Input voltage	$V_{in}$	$V_{SS}-0.3 \sim 7.0$	V
CE Input voltage	$V_{ce}$	$V_{SS}-0.3 \sim V_{in}+0.3$	V
Output voltage	$V_{out}$	$V_{SS}-0.3 \sim V_{in}+0.3$	V
Output current	$I_{out}$	600	mA
Power dissipation	$P_d$	300 (SOT-89) 500 (SOT-89-5) 200 (SOT-23) 300 (SOT-25) 150 (SC-70)(SOT-323) 150 (SC-70-5)	mW
Operating Temperature	$T_{op}$	-40~+85	°C
Storage Temperature	$T_{stg}$	-55~+125	°C

## ■ Selection guide

### ELM88xxxxA-x

Symbol		
a,b	Output voltage	e.g. : 12: Vout=1.2V    18: Vout=1.8V 25: Vout=2.5V    30: Vout=3.0V 33: Vout=3.3V    50: Vout=5.0V
c	CE selection	1 : No CE 3 : CE="H" active
d	Package	A : SOT-89, SOT-89-5 B : SOT-23, SOT-25 C : SC-70(SOT-323), SC-70-5
e	Product version	A
f	Taping direction	S : Refer to PKG file N : Refer to PKG file

ELM88 x x x x A - x  
 ↑ ↑ ↑ ↑ ↑ ↑  
 a b c d e f

## ■ Pin configuration

SOT-89 (TOP VIEW)

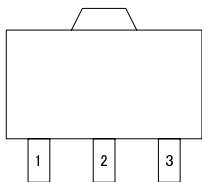

ELM88xx1AA

Pin No.	Pin name
1	VSS
2	VIN
3	VOU

SOT-89-5 (TOP VIEW)

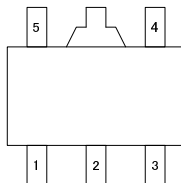

ELM88xx3AA

Pin No.	Pin name
1	VSS
2	VIN
3	VOU
4	NC
5	CE

SOT-23 (TOP VIEW)

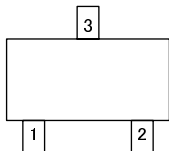

ELM88xx1BA

Pin No.	Pin name
1	VSS
2	VOU
3	VIN

SOT-25 (TOP VIEW)

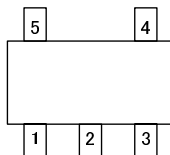

ELM88xx3BA

Pin No.	Pin name
1	VSS
2	VIN
3	VOU
4	NC
5	CE

SC-70 (TOP VIEW)

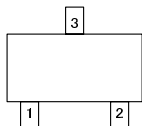

ELM88xx1CA

Pin No.	Pin name
1	VSS
2	VOU
3	VIN

SC-70-5 (TOP VIEW)

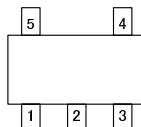

ELM88xx3CA

Pin No.	Pin name
1	VSS
2	VIN
3	VOU
4	NC
5	CE

# ELM88xxxxA CMOS 300mA LDO Voltage regulator

## Standard circuit

ELM88xx1xA

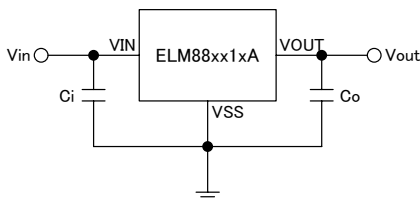

\*  $C_i=1\mu\text{F}$ ,  $C_o=1\mu\text{F}$  or greater

ELM88xx3xA

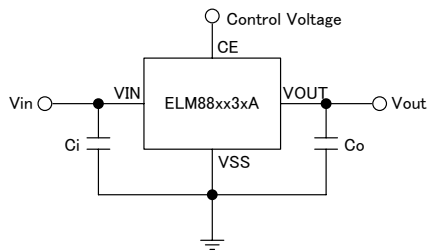

\*  $C_i=1\mu\text{F}$ ,  $C_o=1\mu\text{F}$  or greater

## Block diagram

ELM88xx1xA

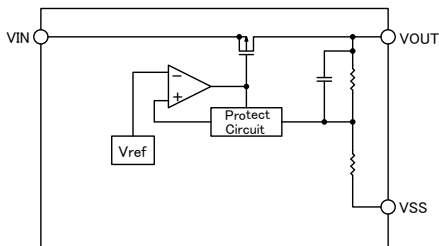

ELM88xx3xA

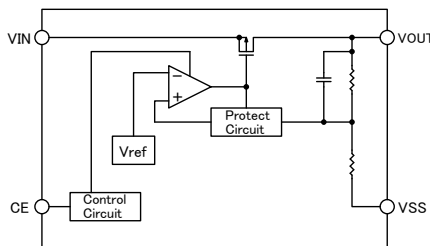

## Electrical characteristics (ELM88xx1xA)

$V_{out}=1.2\text{V}$  (ELM88121xA), No CE pin

$T_{op}=25^\circ\text{C}$

Parameter	Symbol	Condition	Min.	Typ.	Max.	Unit
Output voltage	$V_{out}$	$V_{in}=2.2\text{V}$ , $I_{out}=40\text{mA}$	1.170	1.200	1.230	V
Output current	$I_{out}$	$V_{in}=2.2\text{V}$	300			mA
Input stability	$\Delta V_{out} / \Delta V_{in}$	$I_{out}=40\text{mA}$ , $2.0\text{V} \leq V_{in} \leq 6.0\text{V}$		0.05	0.20	%/V
Load stability	$\Delta V_{out} / \Delta I_{out}$	$1\text{mA} \leq I_{out} \leq 100\text{mA}$ , $V_{in}=2.2\text{V}$		5	20	mV
Input-Output voltage differential	$V_{dif}$	$I_{out}=100\text{mA}$		380	620	mV
Current consumption	$I_{ss}$	$V_{in}=2.2\text{V}$ , No-load		15	50	$\mu\text{A}$
Input voltage	$V_{in}$		1.4		6.0	V
Output voltage temperature coefficient	$\Delta V_{out} / \Delta T_{op}$	$-40^\circ\text{C} \leq T_{op} \leq +85^\circ\text{C}$ , $I_{out}=40\text{mA}$ , $V_{in}=2.2\text{V}$		$\pm 100$		ppm/ $^\circ\text{C}$
Short circuit current	$I_{lim}$	$V_{out}=0\text{V}$		40		mA
Ripple rejection ratio	RR	$f=1\text{kHz}$ , $I_{out}=40\text{mA}$		60		dB
Thermal shutdown temperature	$T_{sd}$			165		$^\circ\text{C}$
Output noise	$V_{no}$	$BW=10\text{Hz} \sim 100\text{kHz}$		30		$\mu\text{V}_{rms}$

# ELM88xxxxA CMOS 300mA LDO Voltage regulator

Vout=1.8V (ELM88181xA), No CE pin

Top=25°C

Parameter	Symbol	Condition	Min.	Typ.	Max.	Unit
Output voltage	Vout	Vin=2.8V, Iout=40mA	1.764	1.800	1.836	V
Output current	Iout	Vin=2.8V	300			mA
Input stability	$\Delta V_{out}/\Delta V_{in}$	Iout=40mA, $2.3V \leq V_{in} \leq 6.0V$		0.02	0.20	%/V
Load stability	$\Delta V_{out}/\Delta I_{out}$	$1mA \leq I_{out} \leq 100mA$ , Vin=2.8V		5	20	mV
Input-Output voltage differential	Vdif	Iout=100mA		145	230	mV
Current consumption	Iss	Vin=2.8V, No-load		15	50	$\mu A$
Input voltage	Vin		1.4		6.0	V
Output voltage temperature coefficient	$\Delta V_{out}/\Delta T_{top}$	$-40^{\circ}C \leq T_{top} \leq +85^{\circ}C$ , Iout=40mA, Vin=2.8V		$\pm 100$		ppm/°C
Short circuit current	Ilim	Vout=0V		40		mA
Ripple rejection ratio	RR	f=1kHz, Iout=40mA		60		dB
Thermal shutdown temperature	Tsd			165		°C
Output noise	Vno	BW=10Hz~100kHz		30		$\mu V_{rms}$

Vout=2.5V (ELM88251xA), No CE pin

Top=25°C

Parameter	Symbol	Condition	Min.	Typ.	Max.	Unit
Output voltage	Vout	Vin=3.5V, Iout=40mA	2.450	2.500	2.550	V
Output current	Iout	Vin=3.5V	300			mA
Input stability	$\Delta V_{out}/\Delta V_{in}$	Iout=40mA, $3.0V \leq V_{in} \leq 6.0V$		0.02	0.20	%/V
Load stability	$\Delta V_{out}/\Delta I_{out}$	$1mA \leq I_{out} \leq 100mA$ , Vin=3.5V		5	20	mV
Input-Output voltage differential	Vdif	Iout=100mA		120	190	mV
Current consumption	Iss	Vin=3.5V, No-load		15	50	$\mu A$
Input voltage	Vin		1.4		6.0	V
Output voltage temperature coefficient	$\Delta V_{out}/\Delta T_{top}$	$-40^{\circ}C \leq T_{top} \leq +85^{\circ}C$ , Iout=40mA, Vin=3.5V		$\pm 100$		ppm/°C
Short circuit current	Ilim	Vout=0V		40		mA
Ripple rejection ratio	RR	f=1kHz, Iout=40mA		60		dB
Thermal shutdown temperature	Tsd			165		°C
Output noise	Vno	BW=10Hz~100kHz		30		$\mu V_{rms}$

# ELM88xxxxA CMOS 300mA LDO Voltage regulator

Vout=3.0V (ELM88301xA), No CE pin

Top=25°C

Parameter	Symbol	Condition	Min.	Typ.	Max.	Unit
Output voltage	Vout	Vin=4.0V, Iout=40mA	2.940	3.000	3.060	V
Output current	Iout	Vin=4.0V	300			mA
Input stability	$\Delta V_{out}/\Delta V_{in}$	Iout=40mA, $3.5V \leq V_{in} \leq 6.0V$		0.02	0.20	%/V
Load stability	$\Delta V_{out}/\Delta I_{out}$	$1mA \leq I_{out} \leq 100mA$ , Vin=4.0V		5	20	mV
Input-Output voltage differential	Vdif	Iout=100mA		110	175	mV
Current consumption	Iss	Vin=4.0V, No-load		15	50	$\mu A$
Input voltage	Vin		1.4		6.0	V
Output voltage temperature coefficient	$\Delta V_{out}/\Delta T_{op}$	$-40^{\circ}C \leq T_{op} \leq +85^{\circ}C$ , Iout=40mA, Vin=4.0V		$\pm 100$		ppm/°C
Short circuit current	Ilim	Vout=0V		40		mA
Ripple rejection ratio	RR	f=1kHz, Iout=40mA		60		dB
Thermal shutdown temperature	Tsd			165		°C
Output noise	Vno	BW=10Hz~100kHz		30		$\mu V_{rms}$

Vout=3.3V (ELM88331xA), No CE pin

Top=25°C

Parameter	Symbol	Condition	Min.	Typ.	Max.	Unit
Output voltage	Vout	Vin=4.3V, Iout=40mA	3.234	3.300	3.366	V
Output current	Iout	Vin=4.3V	300			mA
Input stability	$\Delta V_{out}/\Delta V_{in}$	Iout=40mA, $3.8V \leq V_{in} \leq 6.0V$		0.02	0.20	%/V
Load stability	$\Delta V_{out}/\Delta I_{out}$	$1mA \leq I_{out} \leq 100mA$ , Vin=4.3V		5	20	mV
Input-Output voltage differential	Vdif	Iout=100mA		110	175	mV
Current consumption	Iss	Vin=4.3V, No-load		15	50	$\mu A$
Input voltage	Vin		1.4		6.0	V
Output voltage temperature coefficient	$\Delta V_{out}/\Delta T_{op}$	$-40^{\circ}C \leq T_{op} \leq +85^{\circ}C$ , Iout=40mA, Vin=4.3V		$\pm 100$		ppm/°C
Short circuit current	Ilim	Vout=0V		40		mA
Ripple rejection ratio	RR	f=1kHz, Iout=40mA		60		dB
Thermal shutdown temperature	Tsd			165		°C
Output noise	Vno	BW=10Hz~100kHz		30		$\mu V_{rms}$

# ELM88xxxxA CMOS 300mA LDO Voltage regulator

Vout=5.0V (ELM88501xA), No CE pin

Top=25°C

Parameter	Symbol	Condition	Min.	Typ.	Max.	Unit
Output voltage	Vout	Vin=6.0V, Iout=40mA	4.900	5.000	5.100	V
Output current	Iout	Vin=6.0V	300			mA
Input stability	$\Delta V_{out}/\Delta V_{in}$	Iout=40mA, 5.5V ≤ Vin ≤ 6.0V		0.02	0.20	%/V
Load stability	$\Delta V_{out}/\Delta I_{out}$	1mA ≤ Iout ≤ 100mA, Vin=6.0V		5	20	mV
Input-Output voltage differential	Vdif	Iout=100mA		100	160	mV
Current consumption	I <sub>ss</sub>	Vin=6.0V, No-load		15	50	μA
Input voltage	Vin		1.4		6.0	V
Output voltage temperature coefficient	$\Delta V_{out}/\Delta T_{op}$	-40°C ≤ Top ≤ +85°C, Iout=40mA, Vin=6.0V		±100		ppm/°C
Short circuit current	I <sub>lim</sub>	Vout=0V		40		mA
Ripple rejection ratio	RR	f=1kHz, Iout=40mA		60		dB
Thermal shutdown temperature	T <sub>sd</sub>			165		°C
Output noise	V <sub>no</sub>	BW=10Hz~100kHz		30		μV <sub>rms</sub>

## ■ Electrical characteristics (ELM88xx3xA)

Vout=1.2V (ELM88123xA), CE="H" active

Top=25°C

Parameter	Symbol	Condition	Min.	Typ.	Max.	Unit
Output voltage	Vout	Vin=2.2V, Iout=40mA	1.170	1.200	1.230	V
Output current	Iout	Vin=2.2V	300			mA
Input stability	$\Delta V_{out}/\Delta V_{in}$	Iout=40mA, 2.0V ≤ Vin ≤ 6.0V		0.05	0.20	%/V
Load stability	$\Delta V_{out}/\Delta I_{out}$	1mA ≤ Iout ≤ 100mA, Vin=2.2V		5	20	mV
Input-Output voltage differential	Vdif	Iout=100mA		380	620	mV
Current consumption	I <sub>ss</sub>	Vin=2.2V, No-load		15	50	μA
Stand-by current consumption	I <sub>standby</sub>	Vin=2.2V, Vce=0			0.5	μA
Input voltage	Vin		1.4		6.0	V
CE input voltage High	Vceh	Vin=6.0V	1.8		Vin	V
CE input voltage Low	Vcel	Vin=1.4V	0.0		0.2	V
CE input current High	Iceh	Vce=Vin=6.0V	-0.2	0.0	0.2	μA
CE input current Low	Icel	Vce=Vss, Vin=6.0V	-0.2	0.0	0.2	
Output voltage temperature coefficient	$\Delta V_{out}/\Delta T_{op}$	-40°C ≤ Top ≤ +85°C, Iout=40mA, Vin=2.2V		±100		ppm/°C
Short circuit current	I <sub>lim</sub>	Vout=0V		40		mA
Ripple rejection ratio	RR	f=1kHz, Iout=40mA		60		dB
Thermal shutdown temperature	T <sub>sd</sub>			165		°C
Output noise	V <sub>no</sub>	BW=10Hz~100kHz		30		μV <sub>rms</sub>

# ELM88xxxxA CMOS 300mA LDO Voltage regulator

Vout=1.8V (ELM88183xA), CE="H" active

Top=25°C

Parameter	Symbol	Condition	Min.	Typ.	Max.	Unit
Output voltage	Vout	Vin=2.8V, Iout=40mA	1.764	1.800	1.836	V
Output current	Iout	Vin=2.8V	300			mA
Input stability	$\Delta V_{out}/\Delta V_{in}$	Iout=40mA, 2.3V ≤ Vin ≤ 6.0V		0.02	0.20	%/V
Load stability	$\Delta V_{out}/\Delta I_{out}$	1mA ≤ Iout ≤ 100mA, Vin=2.8V		5	20	mV
Input-Output voltage differential	Vdif	Iout=100mA		145	230	mV
Current consumption	I <sub>ss</sub>	Vin=2.8V, No-load		15	50	μA
Stand-by current consumption	I <sub>standby</sub>	Vin=2.8V, Vce=0			0.5	μA
Input voltage	Vin		1.4		6.0	V
CE input voltage High	Vceh	Vin=6.0V	1.8		Vin	V
CE input voltage Low	Vcel	Vin=1.4V	0.0		0.2	V
CE input current High	Iceh	Vce=Vin=6.0V	-0.2	0.0	0.2	μA
CE input current Low	Icel	Vce=Vss, Vin=6.0V	-0.2	0.0	0.2	
Output voltage temperature coefficient	$\Delta V_{out}/\Delta T_{op}$	-40°C ≤ Top ≤ +85°C Iout=40mA, Vin=2.8V		±100		ppm/°C
Short circuit current	I <sub>lim</sub>	Vout=0V		40		mA
Ripple rejection ratio	RR	f=1kHz, Iout=40mA		60		dB
Thermal shutdown temperature	Tsd			165		°C
Output noise	Vno	BW=10Hz~100kHz		30		μVrms

Vout=2.5V (ELM88253xA), CE="H" active

Top=25°C

Parameter	Symbol	Condition	Min.	Typ.	Max.	Unit
Output voltage	Vout	Vin=3.5V, Iout=40mA	2.450	2.500	2.550	V
Output current	Iout	Vin=3.5V	300			mA
Input stability	$\Delta V_{out}/\Delta V_{in}$	Iout=40mA, 3.0V ≤ Vin ≤ 6.0V		0.02	0.20	%/V
Load stability	$\Delta V_{out}/\Delta I_{out}$	1mA ≤ Iout ≤ 100mA, Vin=3.5V		5	20	mV
Input-Output voltage differential	Vdif	Iout=100mA		120	190	mV
Current consumption	I <sub>ss</sub>	Vin=3.5V, No-load		15	50	μA
Stand-by current consumption	I <sub>standby</sub>	Vin=3.5V, Vce=0			0.5	μA
Input voltage	Vin		1.4		6.0	V
CE input voltage High	Vceh	Vin=6.0V	1.8		Vin	V
CE input voltage Low	Vcel	Vin=1.4V	0.0		0.2	V
CE input current High	Iceh	Vce=Vin=6.0V	-0.2	0.0	0.2	μA
CE input current Low	Icel	Vce=Vss, Vin=6.0V	-0.2	0.0	0.2	
Output voltage temperature coefficient	$\Delta V_{out}/\Delta T_{op}$	-40°C ≤ Top ≤ +85°C Iout=40mA, Vin=3.5V		±100		ppm/°C
Short circuit current	I <sub>lim</sub>	Vout=0V		40		mA
Ripple rejection ratio	RR	f=1kHz, Iout=40mA		60		dB
Thermal shutdown temperature	Tsd			165		°C
Output noise	Vno	BW=10Hz~100kHz		30		μVrms

# ELM88xxxxA CMOS 300mA LDO Voltage regulator

Vout=3.0V (ELM88303xA), CE="H" active

Top=25°C

Parameter	Symbol	Condition	Min.	Typ.	Max.	Unit
Output voltage	Vout	Vin=4.0V, Iout=40mA	2.940	3.000	3.060	V
Output current	Iout	Vin=4.0V	300			mA
Input stability	$\Delta V_{out}/\Delta V_{in}$	Iout=40mA, 3.5V ≤ Vin ≤ 6.0V		0.02	0.20	%/V
Load stability	$\Delta V_{out}/\Delta I_{out}$	1mA ≤ Iout ≤ 100mA, Vin=4.0V		5	20	mV
Input-Output voltage differential	Vdif	Iout=100mA		110	175	mV
Current consumption	I <sub>ss</sub>	Vin=4.0V, No-load		15	50	μA
Stand-by current consumption	I <sub>standby</sub>	Vin=4.0V, Vce=0			0.5	μA
Input voltage	Vin		1.4		6.0	V
CE input voltage High	Vceh	Vin=6.0V	1.8		Vin	V
CE input voltage Low	Vcel	Vin=1.4V	0.0		0.2	V
CE input current High	Iceh	Vce=Vin=6.0V	-0.2	0.0	0.2	μA
CE input current Low	Icel	Vce=Vss, Vin=6.0V	-0.2	0.0	0.2	
Output voltage temperature coefficient	$\Delta V_{out}/\Delta T_{op}$	-40°C ≤ Top ≤ +85°C, Iout=40mA, Vin=4.0V		±100		ppm/°C
Short circuit current	I <sub>lim</sub>	Vout=0V		40		mA
Ripple rejection ratio	RR	f=1kHz, Iout=40mA		60		dB
Thermal shutdown temperature	Tsd			165		°C
Output noise	Vno	BW=10Hz~100kHz		30		μVrms

Vout=3.3V (ELM88333xA), CE="H" active

Top=25°C

Parameter	Symbol	Condition	Min.	Typ.	Max.	Unit
Output voltage	Vout	Vin=4.3V, Iout=40mA	3.234	3.300	3.366	V
Output current	Iout	Vin=4.3V	300			mA
Input stability	$\Delta V_{out}/\Delta V_{in}$	Iout=40mA, 3.8V ≤ Vin ≤ 6.0V		0.02	0.20	%/V
Load stability	$\Delta V_{out}/\Delta I_{out}$	1mA ≤ Iout ≤ 100mA, Vin=4.3V		5	20	mV
Input-Output voltage differential	Vdif	Iout=100mA		110	175	mV
Current consumption	I <sub>ss</sub>	Vin=4.3V, No-load		15	50	μA
Stand-by current consumption	I <sub>standby</sub>	Vin=4.3V, Vce=0			0.5	μA
Input voltage	Vin		1.4		6.0	V
CE input voltage High	Vceh	Vin=6.0V	1.8		Vin	V
CE input voltage Low	Vcel	Vin=1.4V	0.0		0.2	V
CE input current High	Iceh	Vce=Vin=6.0V	-0.2	0.0	0.2	μA
CE input current Low	Icel	Vce=Vss, Vin=6.0V	-0.2	0.0	0.2	
Output voltage temperature coefficient	$\Delta V_{out}/\Delta T_{op}$	-40°C ≤ Top ≤ +85°C, Iout=40mA, Vin=4.3V		±100		ppm/°C
Short circuit current	I <sub>lim</sub>	Vout=0V		40		mA
Ripple rejection ratio	RR	f=1kHz, Iout=40mA		60		dB
Thermal shutdown temperature	Tsd			165		°C
Output noise	Vno	BW=10Hz~100kHz		30		μVrms



# ELM88xxxxA CMOS 300mA LDO Voltage regulator

Vout=5.0V (ELM88503xA), CE="H" active

Top=25°C

Parameter	Symbol	Condition	Min.	Typ.	Max.	Unit
Output voltage	Vout	Vin=6.0V, Iout=40mA	4.900	5.000	5.100	V
Output current	Iout	Vin=6.0V	300			mA
Input stability	$\Delta V_{out}/\Delta V_{in}$	Iout=40mA, 5.5V ≤ Vin ≤ 6.0V		0.02	0.20	%/V
Load stability	$\Delta V_{out}/\Delta I_{out}$	1mA ≤ Iout ≤ 100mA, Vin=6.0V		5	20	mV
Input-Output voltage differential	Vdif	Iout=100mA		100	160	mV
Current consumption	I <sub>ss</sub>	Vin=6.0V, No-load		15	50	μA
Stand-by current consumption	I <sub>standby</sub>	Vin=6.0V, Vce=0			0.5	μA
Input voltage	Vin		1.4		6.0	V
CE input voltage High	Vceh	Vin=6.0V	1.8		Vin	V
CE input voltage Low	Vcel	Vin=1.4V	0.0		0.2	V
CE input current High	Iceh	Vce=Vin=6.0V	-0.2	0.0	0.2	μA
CE input current Low	Icel	Vce=V <sub>ss</sub> , Vin=6.0V	-0.2	0.0	0.2	
Output voltage temperature coefficient	$\Delta V_{out}/\Delta T_{op}$	-40°C ≤ Top ≤ +85°C, Iout=40mA, Vin=6.0V		±100		ppm/°C
Short circuit current	I <sub>lim</sub>	Vout=0V		40		mA
Ripple rejection ratio	RR	f=1kHz, Iout=40mA		60		dB
Thermal shutdown temperature	T <sub>sd</sub>			165		°C
Output noise	V <sub>no</sub>	BW=10Hz~100kHz		30		μV <sub>rms</sub>

## ■ Marking

- SOT-89, SOT-23 package : ELM88xx1xA
- SOT-89-5, SOT-25 package : ELM88xx3xA (with CE)
- SC-70 package : ELM88xx1CA
- SC-70-5 package : ELM88xx3CA (with CE)

SOT-89

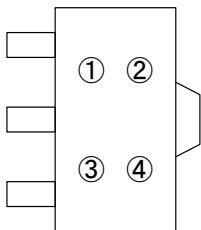

SOP-89-5

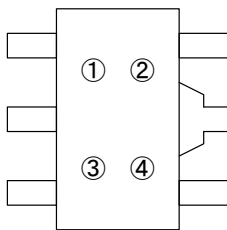

SC-70

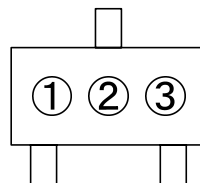

SOT-23

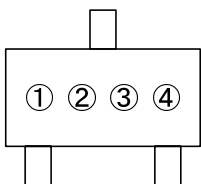

SOT-25

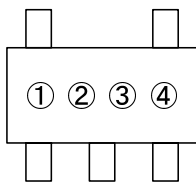

SC-70-5

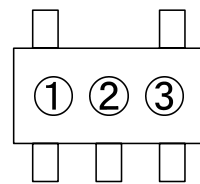

No. ①~④ :  
Assembly lot No.  
A~Z (I, O, X excepted) and 0~9

No. ①~③ :  
Assembly lot No.  
A~Z (I, O, X excepted) and 0~9

## Typical characteristics

- 1.2V Vout unit (ELM8812xxA)

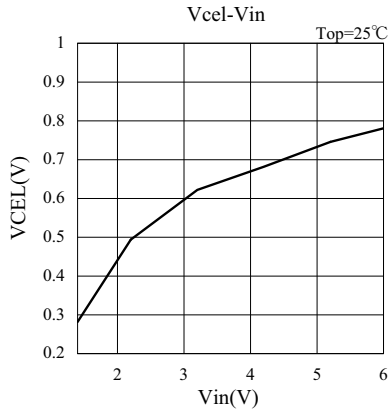
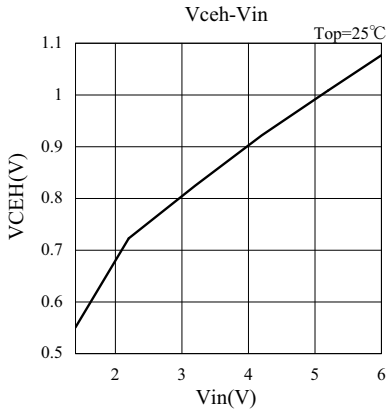
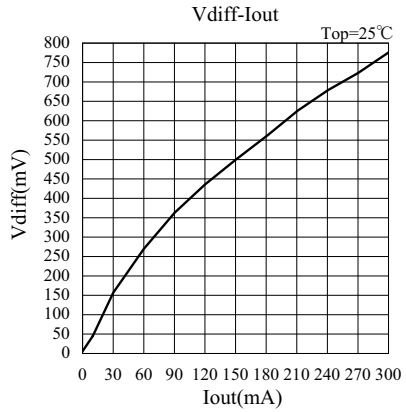
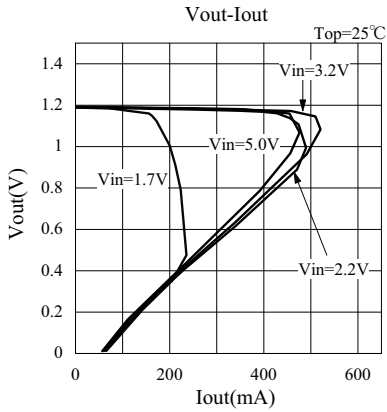
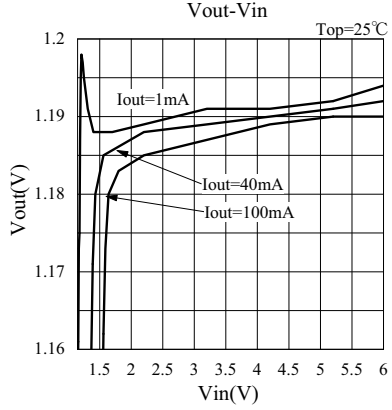
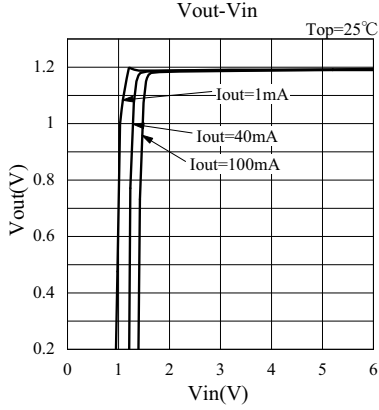

# ELM88xxxxA CMOS 300mA LDO Voltage regulator

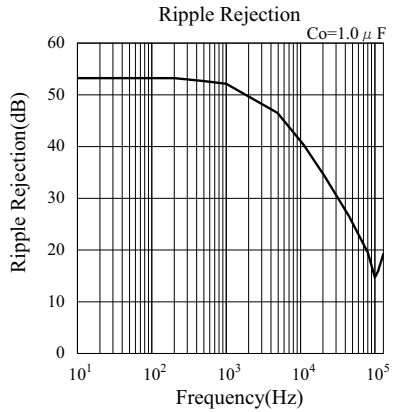
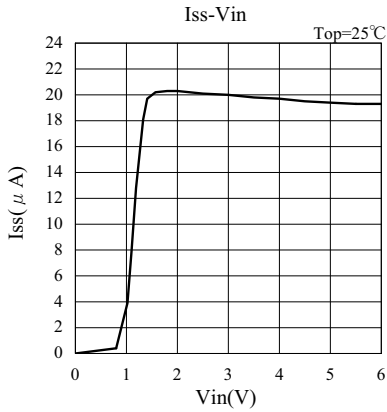
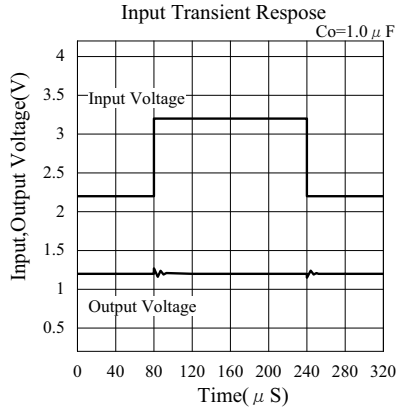
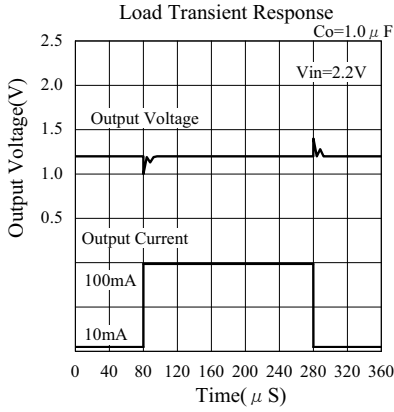

• 1.8V Vout unit (ELM8818xxA)

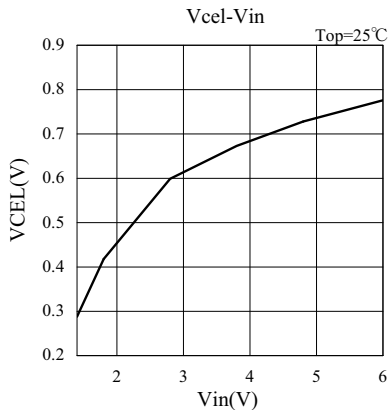
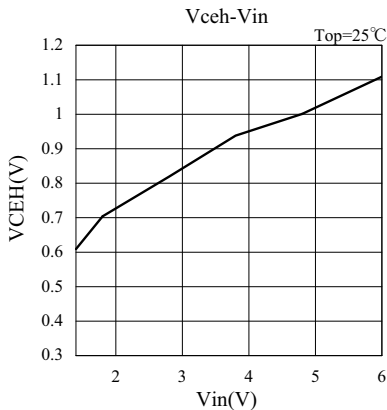
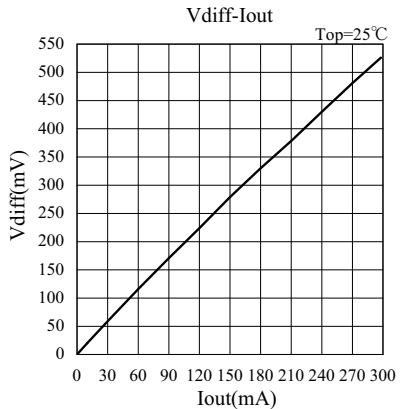
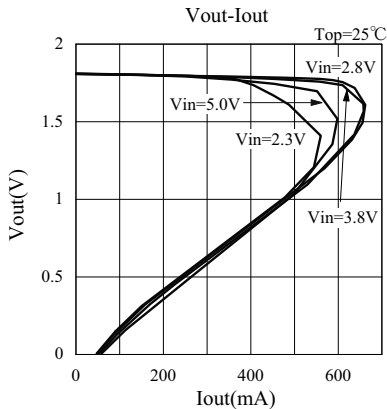
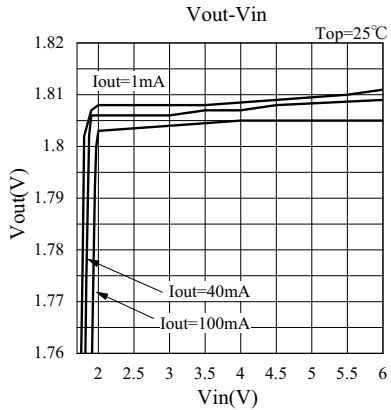
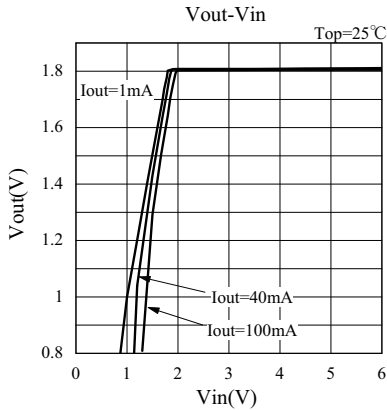

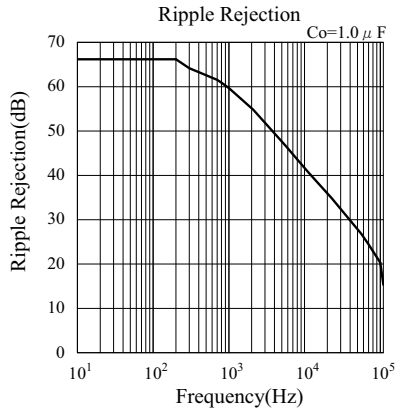
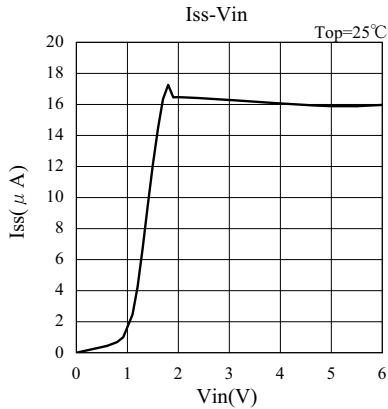
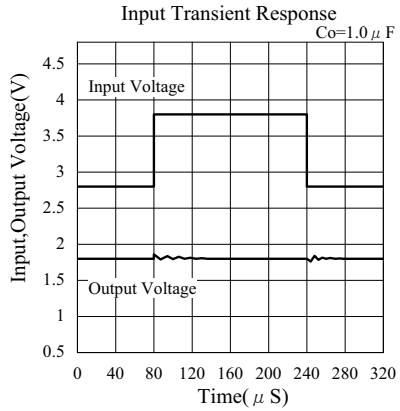
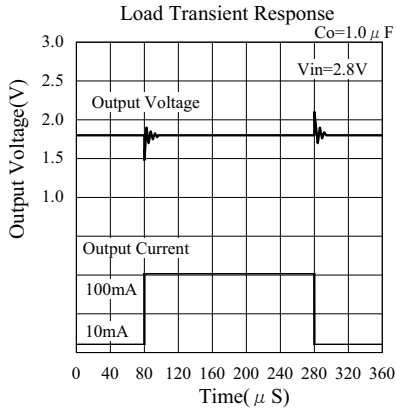

- 2.5V Vout unit (ELM8825xxA)

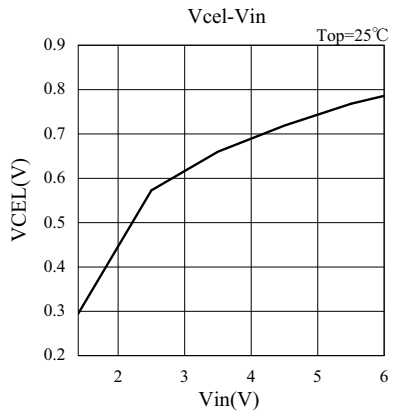
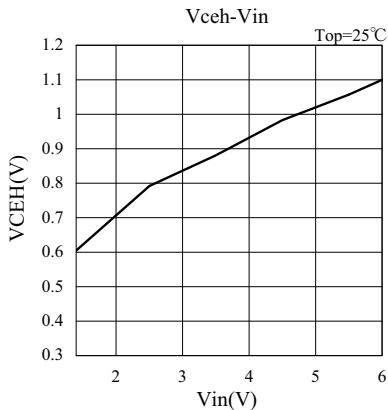
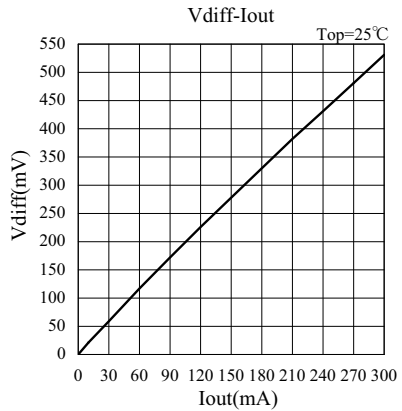
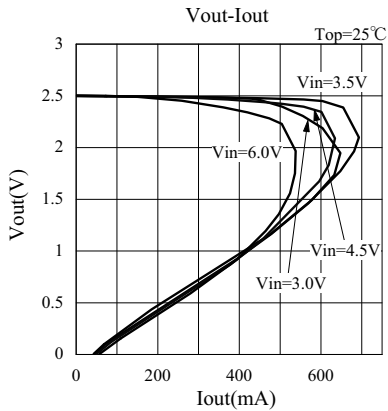
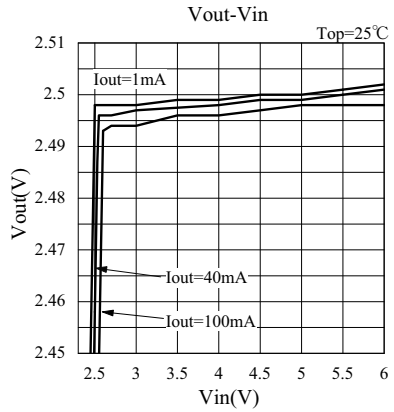
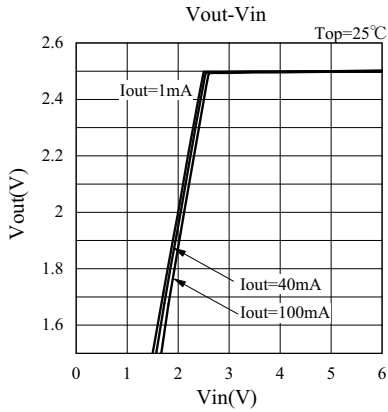

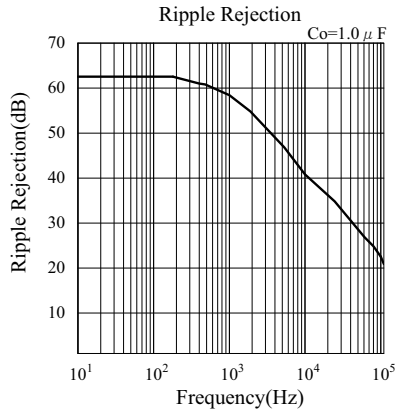
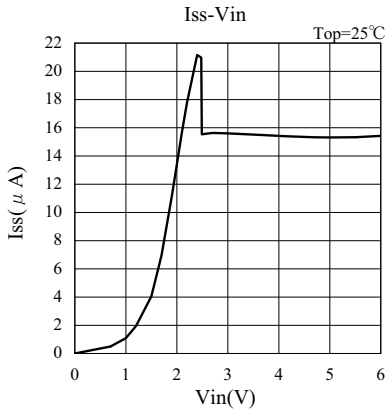
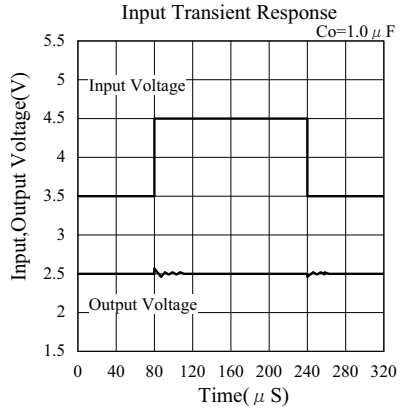
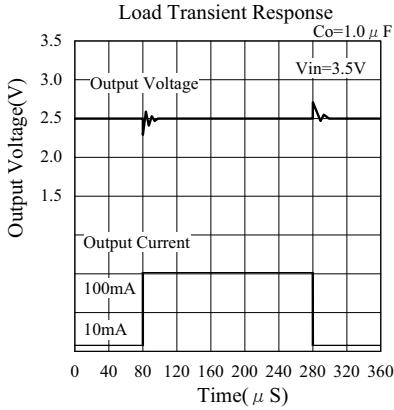

- 3.0V Vout unit (ELM8830xxA)

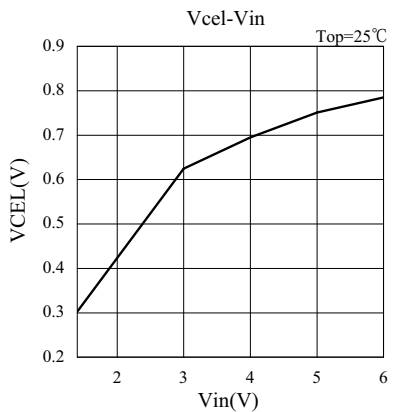
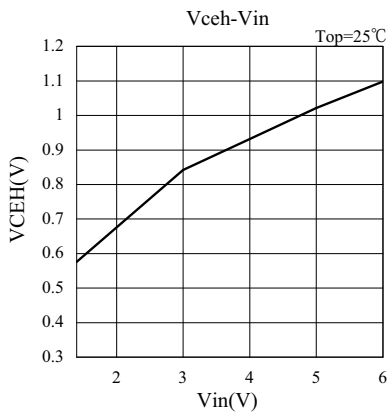
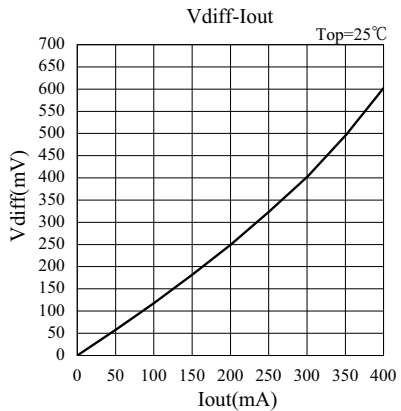
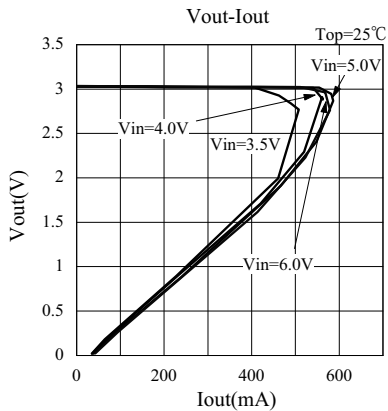
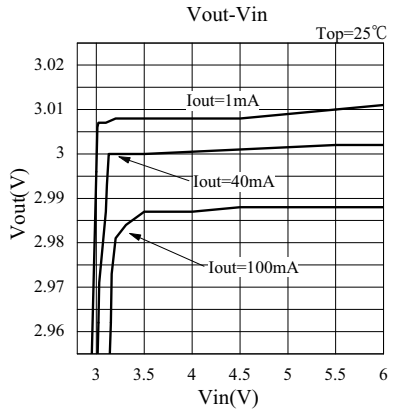
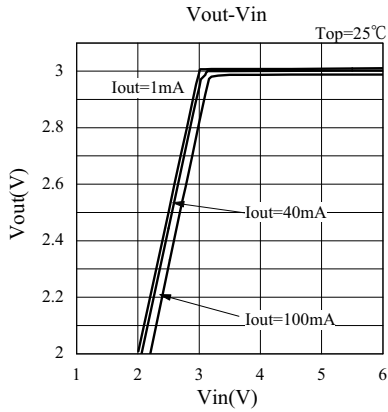



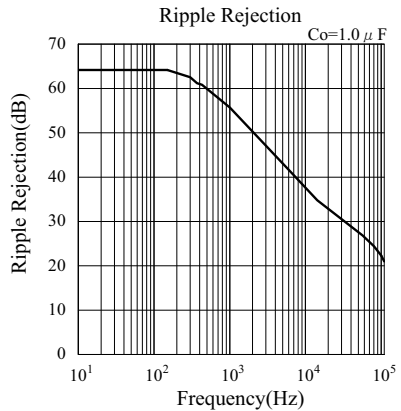
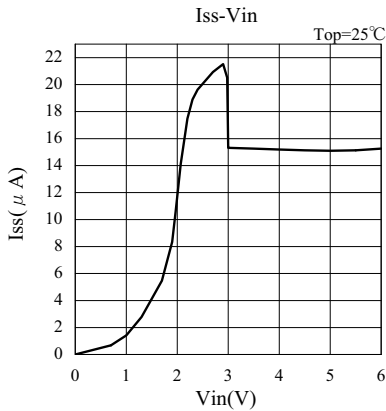
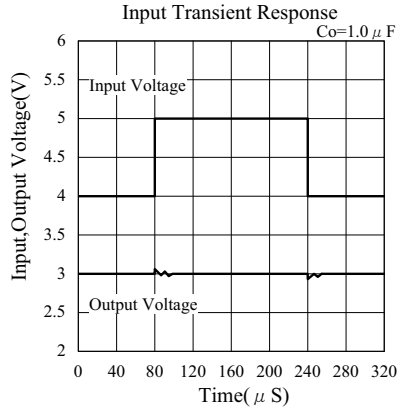
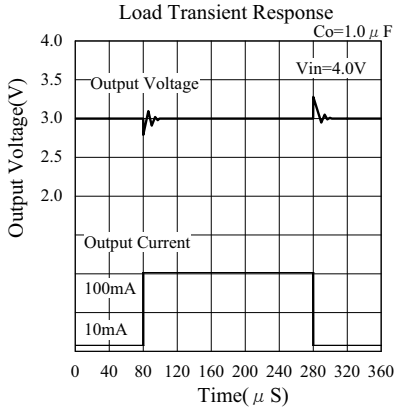

• 3.3V Vout unit (ELM8833xxA)

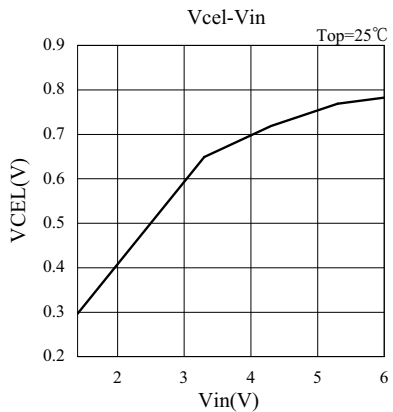
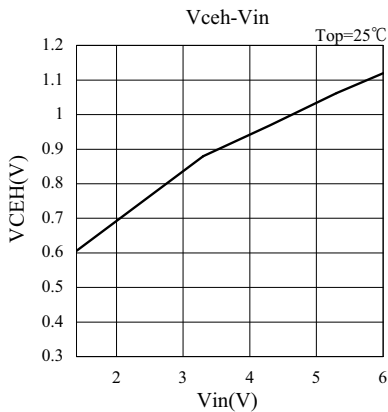
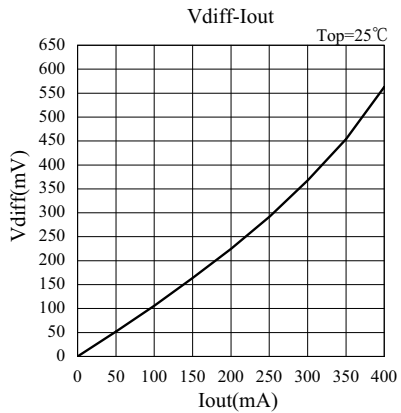
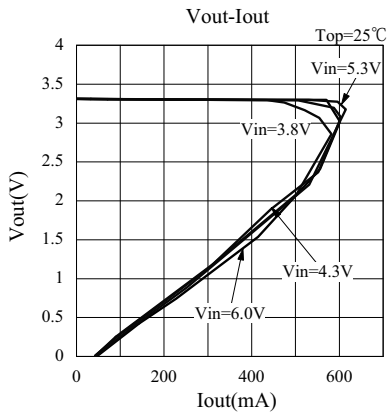
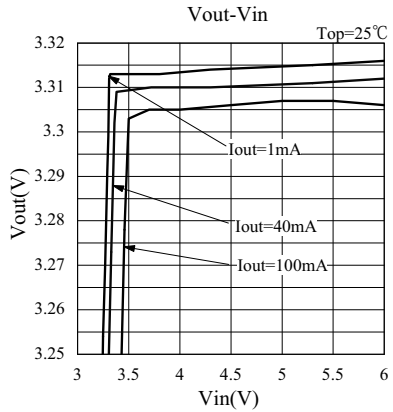
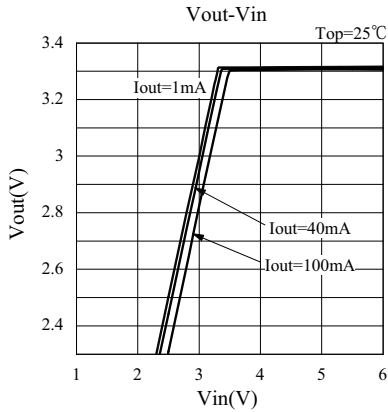

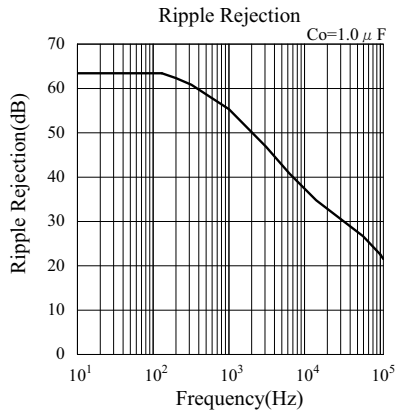
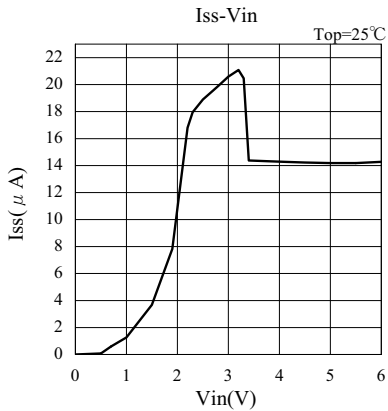
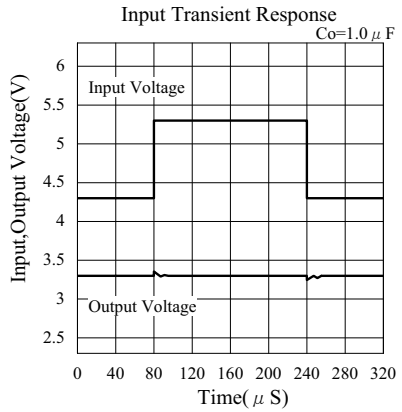
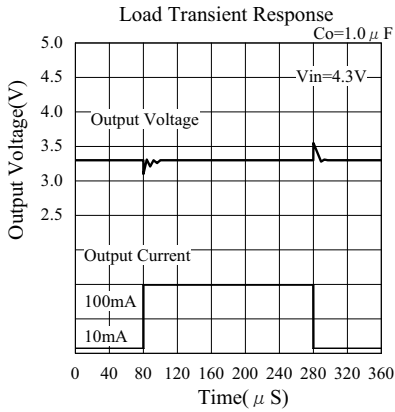

- 5.0V Vout unit (ELM8850xxA)

