

Preliminary

GENERAL DESCRIPTION

The EM83050H microcontroller is dedicated to a keyboard encoder ,specially designed for IBM PC XT/AT and all compatible machines. The EM83050H controll all scan codes, three LEDs status, scan timing and communications between the keyboard and PC. It is easy to implement a high performance, low cost keyboard with the minimal external components.

FEATURES

- Low cost - eliminate need external components.
- Phantom key detects.
- RC oscillator (1.8432MHz).
- Support scan code set 1 ,2 and 3.
- Support PC XT/AT and PS/2 keyboard .
- Low power CMOS device technology.
- Internal pull-up resistor.
- Tri-state outputs for easy board application.
- Built-in 4K ROM.
- Support WINDOWS™ 95, 98 keys.
- 101/104/107 keys or other special application keyboard encoder.
- WINDOWS is registered trademarks of Microsoft corporation.

APPLICATION

- IBM PC XT/AT or compatible machine keyboard.
- IBM PS/2 model 30,50,60,80 or compatible machine keyboard.
- Japanese keyboard.
- Korean keyboard.
- Brazil keyboard.

PIN ASSIGNMENTS

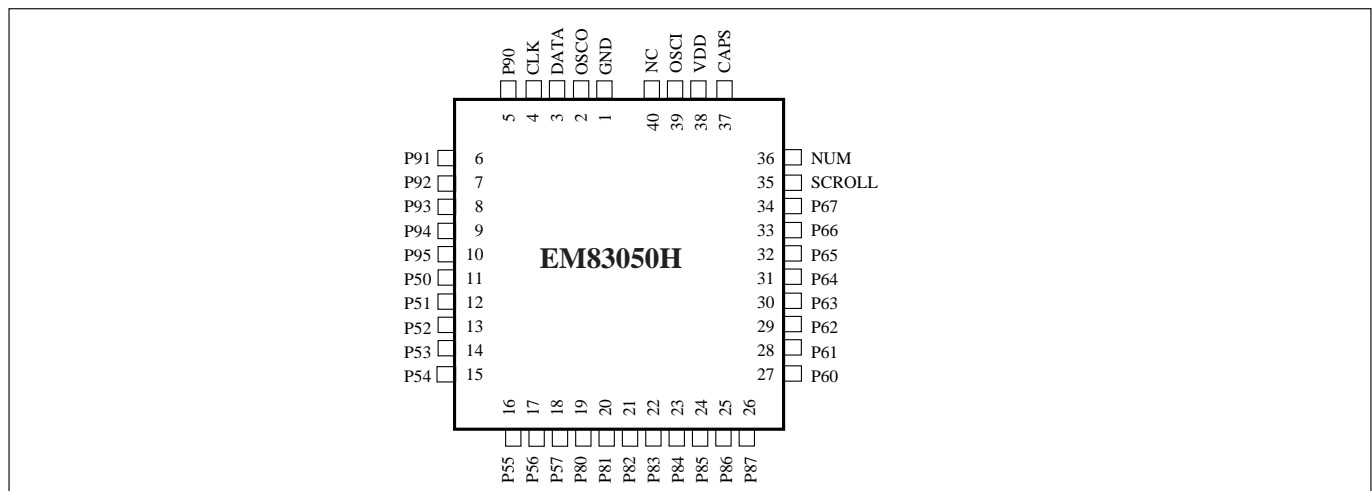

Preliminary

PIN DESCRIPTIONS

Symbol	I/O	Function
P50	O	Column 3 Low output scan line, 3-state
P51	O	Column 4 Low output scan line, 3-state
P52	O	Column 5 Low output scan line, 3-state
P53	O	Column 6 Low output scan line, 3-state
P54	O	Column 7 Low output scan line, 3-state
P55	O	Column 14 Low output scan line, 3-state
P56	O	Column 13 Low output scan line, 3-state
P57	O	Column 12 Low output scan line, 3-state
P80	O	Column 11 Low output scan line, 3-state
P81	O	Column 15 Low output scan line, 3-state
P82	O	Column 10 Low output scan line, 3-state
P83	O	Column 8 Low output scan line, 3-state
P84	O	Column 9 Low output scan line, 3-state
P85	O	Column 0 Low output scan line, 3-state
P86	O	Column 16 Low output scan line, 3-state
P87	O	Column 17 Low output scan line, 3-state
P90	O	Column 1 Low output scan line, 3-state
P91	O	Column 2 Low output scan line, 3-state
VSS	I	Ground
SCROLL	O	Scroll Lock Indicator
NUM	O	NUM Lock Indicator
CAPS	O	Caps Lock Indicator
P60	I	Row 0 Input scan line, internal pull high (10K Ω)
P61	I	Row 1 Input scan line, internal pull high (10K Ω)
P62	I	Row 2 Input scan line, internal pull high (10K Ω)
P63	I	Row 3 Input scan line, internal pull high (10K Ω)
P64	I	Row 4 Input scan line, internal pull high (10K Ω)
P65	I	Row 5 Input scan line, internal pull high (10K Ω)
P66	I	Row 6 Input scan line, internal pull high (10K Ω)
P67	I	Row 7 Input scan line, internal pull high (10K Ω)
CLK	I/O	CLOCK line for IBM communication , internal pull high (2.2K Ω)
DATA	I/O	DATA line for IBM communication , internal pull high (2.2K Ω)
V _{DD}	I	+5V Power Supply
OSCO	O	CLOCK output
OSCR	I	Connect 51K OHM resistor for 1.8432 MHz oscillation
XT	I	"1" or Floating=AT, "0"=XT, internal pull high.

Preliminary

FUNCTION DESCRIPTIONS

Keyboard buffer

The keyboard will buffer 16 bytes in a first-in-first-out order when the system is able to receive scan codes from the keyboard. The response codes and repeated codes will not be buffered. If keystrokes generate a multiple-byte sequence, the entire sequence must fit into the buffer or the keystroke is discarded and a buffer-overflow condition occurs.

Power-on Reset and self test

The duration of the keyboard Power-on-Reset(POR) should be within 150 milliseconds and 2 seconds after the power is applied to the keyboard.

After executing POR, the keyboard executes a self test. The LEDs are turned on at the beginning and off at the end of the self test. The self test takes a minimum 300 milliseconds and a maximum 500 milliseconds. If the self test is successful, a completion code AA hex is sent to the system and the keyboard starts scanning. If the self test fails, an error code is sent, the keyboard is disabled and waits for a command from the system. The completion codes are sent between 450 milliseconds and 2.5 seconds after POR, and between 300 and 500 milliseconds after a RESET command is acknowledged.

Keyboard data output

When the keyboard is ready to send data to the system, it first checks clock and data lines. If either one is in the low state, data is stored in the keyboard buffer. If both are in the high state, keyboard starts clocking data out. Data will be valid before the trailing edge and after the leading edge of the clock pulse. During the transmission the keyboard checks the clock line at least every 60 microseconds. If the system lowers the clock lines before the leading edge of the 10th clock, the keyboard should stop sending, then buffer the data and return clock and data lines to high state.

Keyboard data input

When the system is ready to send data to the keyboard, it first checks clock line to see if keyboard is sending data. If keyboard is not sending data or it is sending data but has not reached the 10th clock, the system can inhibit the interface by forcing the clock line low for more than 60 microseconds and prepares to send data. The keyboard checks clock line status at least every 5 milliseconds. If a system Request to Send(RTS) is detected, the keyboard clocks 11 bits in. After the 10th bit, the keyboard checks for a high state in data line then pulls it low and clocks one more bit to signal the system that data has been received. If data is low after the 10th bit, it indicates a frame error. The keyboard should continue to count until data line goes high, then pulls it low and issues a RESEND to the system.

Command from the system

The system can send commands to the keyboard at any time. The keyboard needs to respond within 20 milliseconds, unless the system prevents keyboard output, when doing self test or executing a RESET. The following are the keyboard input commands and the actions that keyboard needs to take.

Set /Reset Status indicators (Hex ED)

- Responds ACK.
- Receives option byte.

Preliminary

- Responds ACK.
- Updates status indicators.
- Returns to previous scanning state.

Echo (Hex EEH)

- Responds with EE hex.
- Returns to previous scanning state.

Invalid commands (Hex EF and F1)

- Returns a RESEND command.
- Returns to previous scanning state.

Select Alternate Scan Codes (Hex F0)

- Responds ACK.
- Clears output buffer.
- Sets the default typematic rate/delay.
- Clears last typematic key.
- Receives option byte.
- Responds ACK.
- Option byte =
 - 01 : selects scan code set 1
 - 02 : selects scan code set 2
 - 03 : selects scan code set 3
- Returns to previous scanning rate.

Read ID (F2)

- Responds with ACK.
- Discontinues scanning.
- Sends two ID bytes. The second byte will be sent within 500 uS after first byte.
- Resumes scanning.

Set Typematic Rate/Delay (Hex F3)

- Responds ACK.
- Receives rate/delay value byte
- Responds ACK.
- Set rate/delay (* Note 1)
- Returns to previous scanning state.

* Note 1

1. Repeat period = $(8+A) \times (2B) \times 0.00417$ seconds
A : binary value of bits 2, 1, and 0.
B : binary value of bits 4 and 3.
2. Delay = $(C +1) \times 250$ milliseconds
C : binary value of bits 6 and 5. Bit 7 is always 0.

Preliminary

bit 4~ bit 0	typematic rate \pm 20%	bit 4~ bit 0	typematic rate \pm 20%
00000	30.0	10000	7.5
00001	26.7	10001	6.7
00010	24.0	10010	6.0
00011	21.8	10011	5.5
00100	20.0	10100	5.0
00101	18.5	10101	4.6
00110	17.1	10110	4.3
00111	16.0	10111	4.0
01000	15.0	11000	3.7
01001	13.3	11001	3.3
01010	12.0	11010	3.0
01011	10.9	11011	2.7
01100	10.0	11100	2.5
01101	9.2	11101	2.3
01110	8.6	11110	2.1
01111	8.0	11111	2.0

3. Default rate = 10.9 chars/sec + 20%

Default delay = 500 mS \pm 20%

Enable (Hex F4)

- Responds with ACK.
- Clears output buffer.
- Clears last typematic key.
- Start scanning.

Default Disable (Hex F5)

- Responds with ACK.
- Resets all conditions to power-on state.
- Clears output buffer.
- Sets the default key type (scan code set 3 only).
- Set the default typematic rate/delay.
- Clears last typematic key.
- Stops scanning,

Set Default (Hex F6)

- Responds with ACK.
- Resets all conditions to power-on state.
- Clears output buffer.
- Sets the default key type (scan code set 3 only).
- Set the default typematic rate/delay.
- Clears last typematic key.
- Continues scanning,

Set All Keys (Hex F7,F8,F9,FA)

Preliminary

- Responds ACK.
- Clears output buffer.
- Sets all key type (affect only scan code set 3 operation).
 - F7 : Typematic
 - F8 : Make/Break
 - F9 : Make
 - FA : Typematic/Make/Break
- Returns to previous scanning rate.

Set Key Type (Hex FB,FC,FD)

- Responds ACK.
- Clears output buffer.
- Receives key ID byte
- Responds ACK.
- Sets key ID type (affect only scan code set 3 operation).
 - FB : Typematic
 - FC : Make/Break
 - FD : Make
- Returns to previous scanning rate.

Resend (Hex FE)

- Sends the previous output again. If the previous byte is RESEND, the last byte before RESEND shall be sent.

Reset (Hex FF)

- Responds ACK.
- Checks clock and data lines - Reset in the high state for at least 500 microseconds or receives another command.
- Default to scan code set 2.

Command to the system

The following are the keyboard output commands.

Acknowledge (Hex FA)

The keyboard sends an acknowledge in response to any valid command from the system except for RESEND and ECHO.

BAT Completion Code (Hex AA)

This command is issued after successful completion of keyboard self test.

Echo (Hex EE)

The keyboard sends this code in response to an ECHO command.

Preliminary

Keyboards ID (Hex 83AB)

The 2 byte ID is issued to respond to READ ID command. The low byte is sent first, followed by the high byte.

Keyboard buffer Overrun (Hex 00 or FF)

If keyboard buffer overflows, the overrun code will replace the last byte in the buffer. If the keyboard is using scan code set 1 , the code is hex FF. For sets 2 and 3, the code is hex 00.

Resend (Hex FE)

When the keyboard receives an invalid input or any input with incorrect parity, the RESEND command is sent.

Keyboard Scan Code Table

The keyboard contains 3 scan code sets. The system defaults to scan code set 2, but can be switched to set 1 or set 3 . The following tables show the key numbers and three scan code sets in hexadecimal values. All the keys are typematics except for the pause key. When a key is pressed down, the make scan code is sent to the system. When the key is released, its break code is sent. If two or more keys are held down, only the last key pressed repeats at the typematic rate. Typematic operation stops when the last pressed key is released, even if other keys are being released or some other keys are still held down.

The following table shows three scan code sets used in the keyboard.

scan code set 1

Key	Make code	Break code	Key	Make code	Break code
`(~)	29	A9	X	2D	AD
1	02	82	C	2E	AE
2	03	83	V	2F	AF
3	04	84	B	30	B0
4	05	85	N	31	B1
5	06	86	M	32	B2
6	07	87	,(<)	33	B3
7	08	88	.(>)	34	B4
8	09	89	/(?)	35	B5
9	0A	8A	SHIFT_R	36	B6
0	0B	8B	CTRL_L	1D	9D
-(-)	0C	8C	ALT_L	38	B8
=(+)	0D	8D	SPACE	39	B9
BACK SPACE	0E	8E	ALT_R	E0 38	E0 B8
TAB	0F	8F	CTRL_R	E0 1D	E0 9D
Q	10	90	NUM	45	C5
W	11	91	(7)	47	C7
E	12	92	(4)	4B	CB
R	13	93	(1)	4F	CF
T	14	94	(8)	48	C8
Y	15	95	(5)	4C	CC



Preliminary

Key	Make code	Break code	Key	Make code	Break code
U	16	96	(2)	50	D0
I	17	97	(θ)	52	D2
O	18	98	(*)	37	B7
P	19	99	(9)	49	C9
[({)	1A	9A	(6)	4D	CD
]})	1B	9B	(3)	51	D1
\(:)@1	2B	AB	(DEL)	53	D3
CAPS	3A	BA	(-)	4A	CA
A	1E	9E	(+)	4E	CE
S	1F	9F	(ENTER)	E0 1C	E0 9C
D	20	A0	ESC	01	81
F	21	A1	F1	3B	BB
G	22	A2	F2	3C	BC
H	23	A3	F3	3D	BD
J	24	A4	F4	3E	BE
K	25	A5	F5	3F	BF
L	26	A6	F6	40	C0
;(:	27	A7	F7	41	C1
'(")	28	A8	F8	42	C2
K42 @2	2B	AB	F9	43	C3
ENTER	1C	9C	F10	44	C4
SHIFT_L	2A	AA	F11	57	D7
K45 @2	56	D6	F12	58	D8
Z	2C	AC	SCROLL	46	C6

Key	Base Case,or Shift + Nun Lock Make/Break	Shift Case @3 Make/Break	Num Lock Make/Break
INS	E0 52 / E0 D2	E0 AA E0 52 / E0 D2 E0 2A	E0 2A E0 52 / E0 D2 E0 AA
DEL	E0 53 / E0 D3	E0 AA E0 53 / E0 D3 E0 2A	E0 2A E0 53 / E0 D3 E0 AA
LEFT	E0 4B / E0 CB	E0 AA E0 4B / E0 CB E0 2A	E0 2A E0 4B / E0 CB E0 AA
HOME	E0 47 / E0 C7	E0 AA E0 47 / E0 C7 E0 2A	E0 2A E0 47 / E0 C7 E0 AA
END	E0 4F / E0 CF	E0 AA E0 4F / E0 CF E0 2A	E0 2A E0 4F / E0 CF E0 AA
UP	E0 48 / E0 C8	E0 AA E0 48 / E0 C8 E0 2A	E0 2A E0 48 / E0 C8 E0 AA
DOWN	E0 50 / E0 D0	E0 AA E0 50 / E0 D0 E0 2A	E0 2A E0 50 / E0 D0 E0 AA
PAGE UP	E0 49 / E0 C9	E0 AA E0 49 / E0 C9 E0 2A	E0 2A E0 49 / E0 C9 E0 AA
PAGE DOWN	E0 51 / E0 D1	E0 AA E0 51 / E0 D1 E0 2A	E0 2A E0 51 / E0 D1 E0 AA
RIGHT	E0 4D / ED CD	E0 AA E0 4D / E0 CD E0 2A	E0 2A E0 4D / E0 CD E0 AA

Preliminary

Key (/)	Scan Code Make/Break E0 35 / E0 B5	Shift Case Make/Break @3 E0 AA E0 35 / E0 B5 E0 2A	
Key PRINT	Scan Code Make/Break E0 2A E0 37 / E0 B7 E0 AA	Ctrl Case, Shift Case Make/ Break E0 37 / E0 B7	Alt Case Make/Break 54 / D4
Key PAUSE @4	Make Code E1 1D 45 E1 9D C5	Ctrl Key Pressed E0 46 E0 C6	

Note .

@1 : 101-key keyboard only.

@2 : 102-key keyboard only.

@3 : If the left Shift key is held down, the AA/2A shift make and break is sent with the other scan codes.
If the right Shift key is held down, B6/36 is sent. If both Shift keys are down, both sets of codes are sent with the other scan code.

@4 : This key is not typematic. All associated scan codes occur on the make of the key.

scan code set 2

Key	Make code	Break code	Key	Make code	Break code
`(~)	0E	F0 0E	X	22	F0 22
1	16	F0 16	C	21	F0 21
2	1E	F0 1E	V	2A	F0 2A
3	26	F0 26	B	32	F0 32
4	25	F0 25	N	31	F0 31
5	2E	F0 2E	M	3A	F0 3A
6	36	F0 36	.(,<)	41	F0 41
7	3D	F0 3D	.(,>)	49	F0 49
8	3E	F0 3E	/(?)	4A	F0 4A
9	46	F0 46	SHIFT_R	59	F0 59
0	45	F0 45	CTRL_L	14	F0 14
-(-)	4E	F0 4E	ALT_L	11	F0 11
=(+)	55	F0 55	SPACE	29	F0 29
BACK SPACE	66	F0 66	ALT_R	E0 11	E0 F0 11
TAB	0D	F0 0D	CTRL_R	E0 14	E0 F0 14
Q	15	F0 15	NUM	77	F0 77
W	1D	F0 1D	(7)	6C	F0 6C
E	24	F0 24	(4)	6B	F0 6B
R	2D	F0 2D	(1)	69	F0 69
T	2C	F0 2C	(8)	75	F0 75
Y	35	F0 35	(5)	73	F0 73
U	3C	F0 3C	(2)	72	F0 72
I	43	F0 43	(0)	70	F0 70
O	44	F0 44	(*)	7C	F0 7C
P	4D	F0 4D	(9)	7D	F0 7D
[({)	54	F0 54	(6)	74	F0 74
]})	5B	F0 5B	(3)	7A	F0 7A
\(:)@5	5D	F0 5D	(DEL)	71	F0 71



Preliminary

Key	Make code	Break code	Key	Make code	Break code
CAPS	58	F0 58	(-)	7B	F0 7B
A	1C	F0 1C	(+)	79	F0 79
S	1B	F0 1B	(ENTER)	E0 5A	E0 F0 5A
D	23	F0 23	ESC	76	F0 76
F	2B	F0 2B	F1	05	F0 05
G	34	F0 34	F2	06	F0 06
H	33	F0 33	F3	04	F0 04
J	3B	F0 3B	F4	0C	F0 0C
K	42	F0 42	F5	03	F0 03
L	4B	F0 4B	F6	0B	F0 0B
;(,)	4C	F0 4C	F7	83	F0 83
'(")	52	F0 52	F8	0A	F0 0A
K42 @6	5D	F0 5D	F9	01	F0 01
ENTER	5A	F0 5A	F10	09	F0 09
SHIFFT_L	12	F0 12	F11	78	F0 78
K45 @6	61	F0 61	F12	07	F0 07
Z	1A	F0 1A	SCROLL	7E	F0 7E

Key	Base Case,or Shift + Nun Lock Make/Break	Shift Case @7 Make/Break	Num Lock Make/Break
INS	E0 70 / E0 F0 70	E0 F0 12 E0 70 / E0 F0 70 E0 12	E0 12 E0 70 / E0 F0 70 E0 F0 12
DEL	E0 71 / E0 F0 71	E0 F0 12 E0 71 / E0 F0 71 E0 12	E0 12 E0 71 / E0 F0 71 E0 F0 12
LEFT	E0 6B / E0 F0 6B	E0 F0 12 E0 6B / E0 F0 6B E0 12	E0 12 E0 6B / E0 F0 6B E0 F0 12
HOME	E0 6C / E0 F0 6C	E0 F0 12 E0 6C / E0 F0 6C E0 12	E0 12 E0 6C / E0 F0 6C E0 F0 12
END	E0 69 / E0 F0 69	E0 F0 12 E0 69 / E0 F0 69 E0 12	E0 12 E0 69 / E0 F0 69 E0 F0 12
UP	E0 75 / E0 F0 75	E0 F0 12 E0 75 / E0 F0 75 E0 12	E0 12 E0 75 / E0 F0 75 E0 F0 12
DOWN	E0 72 / E0 F0 72	E0 F0 12 E0 72 / E0 F0 72 E0 12	E0 12 E0 72 / E0 F0 72 E0 F0 12
PAGE UP	E0 7D / E0 F0 7D	E0 F0 12 E0 7D / E0 F0 7D E0 12	E0 12 E0 7D / E0 F0 7D E0 F0 12
PAGE DOWN	E0 7A / E0 F0 7A	E0 F0 12 E0 7A / E0 F0 7A E0 12	E0 12 E0 7A / E0 F0 7A E0 F0 12
RIGHT	E0 74 / E0 F0 74	E0 F0 12 E0 74 / E0 F0 74 E0 12	E0 12 E0 74 / E0 F0 74 E0 F0 12

Key	Scan Code Make/Break	Shift Case Make/Break @7
(/)	E0 4A / E0 F0 4A	E0 F0 12 E0 4A / E0 F0 4A E0 12

Key	Scan Code Make/Break	Ctrl Case, Shift Case Make/ Break	Alt Case Make/Break
PRINT	E0 12 E0 7C / E0 F0 7C E0 F0 12	E0 7C / E0 F0 7C	84 / F0 84

Preliminary

Key	Make Code	Ctrl Key Pressed
PAUSE @8	E1 14 77 E1 F0 14 F0 77	E0 7E E0 F0 7E

Note .

@5 : 101-key keyboard only.

@6 : 102-key keyboard only.

@7 : If the left Shift key is held down, the F0 12/12 shift make and break is sent with the other scan codes. If the right Shift key is held down, F0 59/59 is sent. If both Shift keys are down, both sets of codes are sent with the other scan code.

@8 : This key is not typematic. All associated scan codes occur on the make of the key.

scan code set 3

Key	Make Code	Break Code	Default Key State
`(~)	0E	F0 0E	Typematic
1	16	F0 16	Typematic
2	1E	F0 1E	Typematic
3	26	F0 26	Typematic
4	25	F0 25	Typematic
5	2E	F0 2E	Typematic
6	36	F0 36	Typematic
7	3D	F0 3D	Typematic
8	3E	F0 3E	Typematic
9	46	F0 46	Typematic
0	45	F0 45	Typematic
-(_)	4E	F0 4E	Typematic
=(+)	55	F0 55	Typematic
BACK SPACE	66	F0 66	Typematic
TAB	0D	F0 0D	Typematic
Q	15	F0 15	Typematic
W	1D	F0 1D	Typematic
E	24	F0 24	Typematic
R	2D	F0 2D	Typematic
T	2C	F0 2C	Typematic
Y	35	F0 35	Typematic
U	3C	F0 3C	Typematic
I	43	F0 43	Typematic
O	44	F0 44	Typematic
P	4D	F0 4D	Typematic
[({)	54	F0 54	Typematic
]})	5B	F0 5B	Typematic
\() @9	5C	F0 5C	Typematic
CAPS	14	F0 14	Make/Break
A	1C	F0 1C	Typematic
S	1B	F0 1B	Typematic
D	23	F0 23	Typematic
F	2B	F0 2B	Typematic
G	34	F0 34	Typematic
H	33	F0 33	Typematic



Preliminary

Key	Make Code	Break Code	Default Key State
J	3B	F0 3B	Typematic
K	42	F0 42	Typematic
L	4B	F0 4B	Typematic
;(:)	4C	F0 4C	Typematic
'(")	52	F0 52	Typematic
K42 @10	53	F0 53	Typematic
ENTER	5A	F0 5A	Typematic
SHIFT_L	12	F0 12	Make/Break
K45 @10	13	F0 13	Typematic
Z	1A	F0 1A	Typematic
X	22	F0 22	Typematic
C	21	F0 21	Typematic
V	2A	F0 2A	Typematic
B	32	F0 32	Typematic
N	31	F0 31	Typematic
M	3A	F0 3A	Typematic
,(<)	41	F0 41	Typematic
.(>)	49	F0 49	Typematic
/(?)	4A	F0 4A	Typematic
SHIFT_R	59	F0 59	Make/Break
CTRL_L	11	F0 11	Make/Break
ALT_L	19	F0 19	Make/Break
SPACE	29	F0 29	Typematic
ALT_R	39	F0 39	Make only
CTRL_R	58	F0 58	Make only
INS	67	F0 67	Make only
DEL	64	F0 64	Typematic
LEFT	61	F0 61	Typematic
HOME	6E	F0 6E	Make only
END	65	F0 65	Make only
UP	63	F0 63	Typematic
DOWN	60	F0 60	Typematic
PAGE UP	6F	F0 6F	Make only
PAGE DOWN	6D	F0 6D	Make only
RIGHT	6A	F0 6A	Typematic
NUM	76	F0 76	Make only
(7)	6C	F0 6C	Make only
(4)	6B	F0 6B	Make only
(1)	69	F0 69	Make only
(/)	77	F0 77	Make only
(8)	75	F0 75	Make only
(5)	73	F0 73	Make only
(2)	72	F0 72	Make only
(0)	70	F0 70	Make only
(*)	7E	F0 7E	Make only
(9)	7D	F0 7D	Make only
(6)	74	F0 74	Make only
(3)	7A	F0 7A	Make only

* This specification are subject to be changed without notice.

Preliminary

Key	Make Code	Break Code	Default Key State
(DEL)	71	F0 71	Make only
(-)	84	F0 84	Make only
(+)	7C	F0 7C	Typematic
(ENTER)	79	F0 79	Make only
ESC	08	F0 08	Make only
F1	07	F0 07	Make only
F2	0F	F0 0F	Make only
F3	17	F0 17	Make only
F4	1F	F0 1F	Make only
F5	27	F0 27	Make only
F6	2F	F0 2F	Make only
F7	37	F0 37	Make only
F8	3F	F0 3F	Make only
F9	47	F0 47	Make only
F10	4F	F0 4F	Make only
F11	56	F0 56	Make only
F12	5E	F0 5E	Make only
PRINT	57	F0 57	Make only
SCROLL	5F	F0 5F	Make only
PAUSE	62	F0 62	Make only

Note .

@9 : 101-key keyboard only

@10 : 102-key keyboard only

New key codes for scan set 1:

New key	Make	Break
LWIN	E0 5B	E0 DB
RWIN	E0 5C	E0 DC
APP	E0 5D	E0 DD
N-CHG (131)	7B	FB
CHG (132)	79	F9
ROMA (133)	70	F0
K14	7D	FD
K56	73	F3
K107	7E	FE
KL	F1	X
KR	F0	X
POWER	E0 5E	E0 DE
SLEEP	E0 5F	E0 DF
WAKE UP	E0 63	E0 E3

Preliminary

New key codes for scan set 2:

New key	Make		Break		
LWIN	E0	1F	E0	F0	1F
RWIN	E0	27	E0	F0	27
APP	E0	2F	E0	F0	2F
N-CHG (131)		67	F0		67
CHG (132)		64	F0		64
ROMA (133)		13	F0		13
K14		6A	F0		6A
K56		51	F0		51
K107		6D	F0		6D
KL		F1			X
KR		F2			X
POWER	E0	37	E0	F0	37
SLEEP	E0	3F	E0	F0	3F
WAKE UP	E0	5E	E0	F0	5E

New key codes for scan set 3:

New key	Make	Break		
LWIN	8B	F0	8B	MAKE/BREAK
RWIN	8C	F0	8C	MAKE/BREAK
APP	8D	F0	8D	MAKE/BREAK
N-CHG (131)	85	F0	85	MAKE
CHG (132)	86	F0	86	MAKE
ROMA (133)	87	F0	87	MAKE
K14	5D	F0	5D	TYPOMATIC
K56	51	F0	51	TYPOMATIC
K107	7B	F0	7B	TYPOMATIC
KL	F1		X	
KR	F2		X	
POWER	X		X	
SLEEP	X		X	
WAKE UP	X		X	

Preliminary

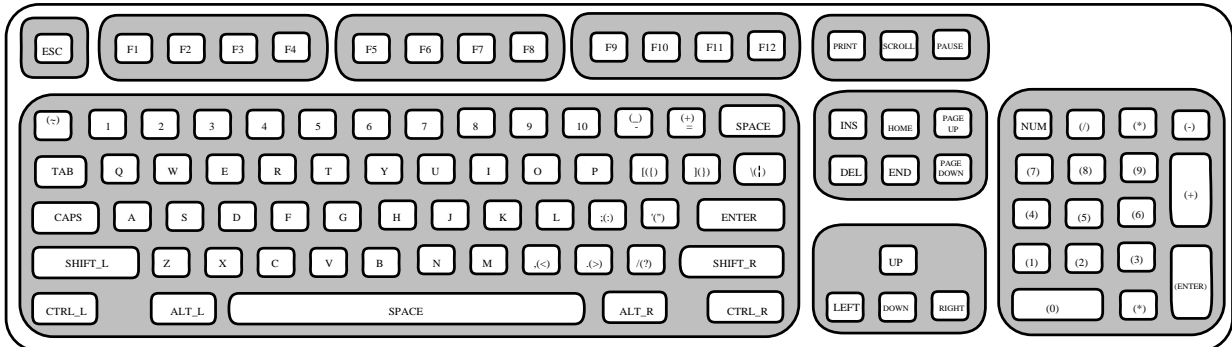

Fig 1. The 101-key keyboard layout

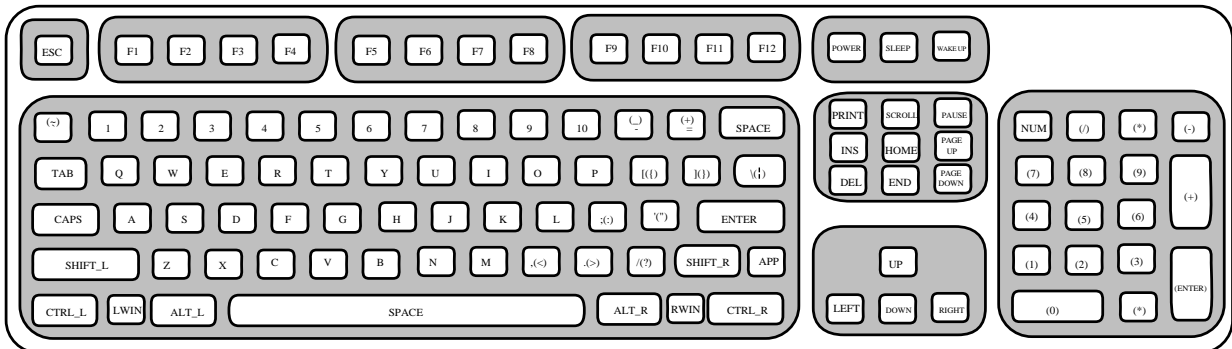

Fig 2. The 107-key keyboard layout

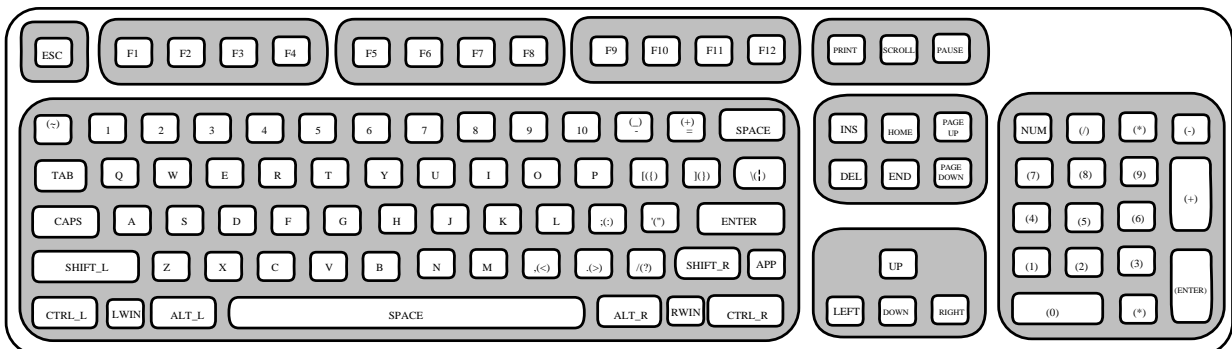

Fig 3. The 104-key keyboard layout

Preliminary

ABSOLUTE MAXIMUM RATINGS

Parameter	Sym.	Ratings
Supply Voltage	V_{CC}	-0.5V to +7V
Input Voltage	V_{IN}	-0.3V to +6V
Output Voltage	V_{OUT}	-0.3V to +6V
Temperature under bias	T_B	0°C to 70°C
Storage temperature	T_S	-65°C to 150°C

DC ELECTRICAL CHARACTERISTICS

Parameter	Sym.	Min.	Typ.	Max.	Unit	Condition
Operating voltage	V_{CC}	4.5	5	5.5	V	
Operating supply current	I_{CCI}			3	mA	Fosc=1.8432MHz
Input leakage	I_{IL}			±1	μA	$V_{IN}=V_{CC}, V_{SS}$
Input high voltage	V_{IH}	2.0			V	
Input low voltage	V_{IL}			0.8	V	
Output high voltage	V_{OH1}	2.4			V	$I_{OH} = -6.0$ mA
Output low voltage	V_{OL1}			0.4	V	$I_{OL} = 3.0$ mA
Output low voltage for LEDS	V_{OL3}			3.2	V	$I_{OL} = 10$ mA
Internal Pull-high resistance (port 6,9)	R_{PH1}	4.7		10	KΩ	
Internal Pull-high resistance for DATA, CLK	R_{PH2}	1.5	2.2	3	KΩ	

AC ELECTRICAL CHARACTERISTICS

Parameter	Sym.	Min.	Typ.	Max.	Unit
Time from DATA transition to falling edge of CLK	T1	5		25	μS
Time from rising edge of CLK to DATA transition	T2	5		T4 - 5	μS
Duration of CLK inactive	T3	30	40	50	μS
Duration of CLK active	T4	30	40	50	μS
Time to auxiliary device inhibit after clock 11 to ensure the auxiliary device does not start another transmission	T5			50	μS
Time from inactive to active CLK transition, used to time when auxiliary device samples DATA	T6	5		25	μS
System clock	FCLK		1.843		MHz

Preliminary

TIMING DIAGRAMS

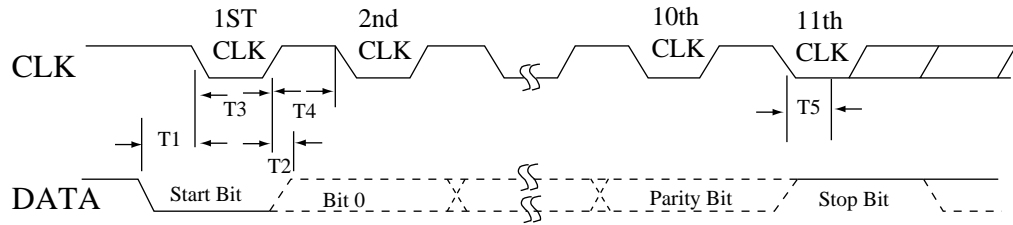

Fig 3. Keyboard output data timings

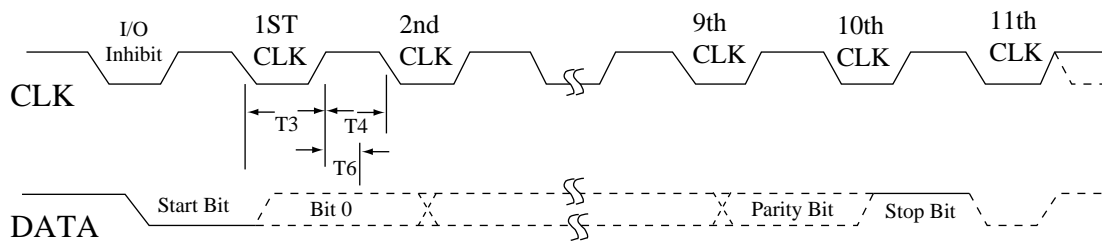
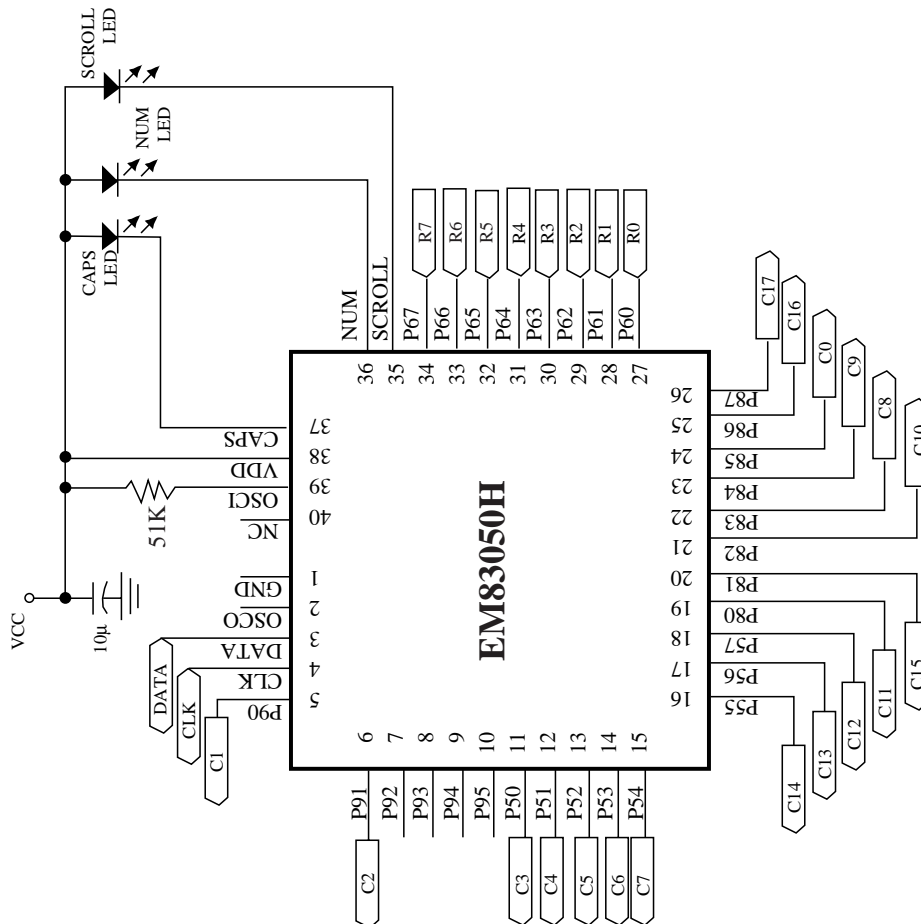

Fig 4. Keyboard input data timings

Preliminary

APPLICATION CIRCUIT

	R0	R1	R2	R3	R4	R5	R6	R7
C0	PAUSE 126	POWER		SLEEP	CTRL-R 064	WAKE UP	CTRL-L 058	F5 116
C1	Q 017	TAB 016	A 031	ESC 110	Z 046	N-CHG 131	`(-) 001	I(O) 002
C2	W 018	CAP 030	S 032	K45 045	X 047	CHG 132	F1 112	2(@) 003
C3	E 019	F3 114	D 033	F4 115	C 048	ROMA 133	F2 113	3(#) 004
C4	R 020	T 021	F 034	G 035	V 049	B 050	5(%) 006	4(\$) 005
C5	U 023	Y 022	J 037	H 036	M 052	N 051	6(*) 007	7(& 008
C6	I 024	[(] 028	K 038	F6 117	-(053	K56 056	+'(=) 013	8(*) 009
C7	O 025	F7 118	L 039		-(054	APP 055	F8 119	9(') 010
C8	P 026	[(] 027	:(040	(") 041	K42 042	/(?) 055	_(-) 012	0(') 011
C9	SCROLL 125			ALT-L 060	ALT-R 062			PRINT 124
C10	K14 014	BACK 015	() 029	F11 122	ENTER 043	F12 123	P9 120	F10 121
C11	7 (K) 091	4 (K) 092	1 (K) 093	SPACE 061	NUM 090	↓ 084	DEL 076	POWER
C12	8 (K) 096	5 (K) 097	2 (K) 098	0 (K) 099	/ (K) 104	→ 089	INS 075	SLEEP
C13	9 (K) 101	6 (K) 102	3 (K) 103	· (K) 104	* (K) 100	· 105	PAGE UP 085	PAGE DOWN 086
C14	+ (K) 106	K107 (K) 108	ENTER (K) 108	↑ 083		← 079	HOME 080	END 081
C15	WAKE UP	SHIFT-L	SHIFT-R					
C16								
C17	K150 (KC-L)	WIN-L	WIN-R		KC-L		KC-R KR	K151 (KC-R)



Preliminary

PAD DIAGRAM

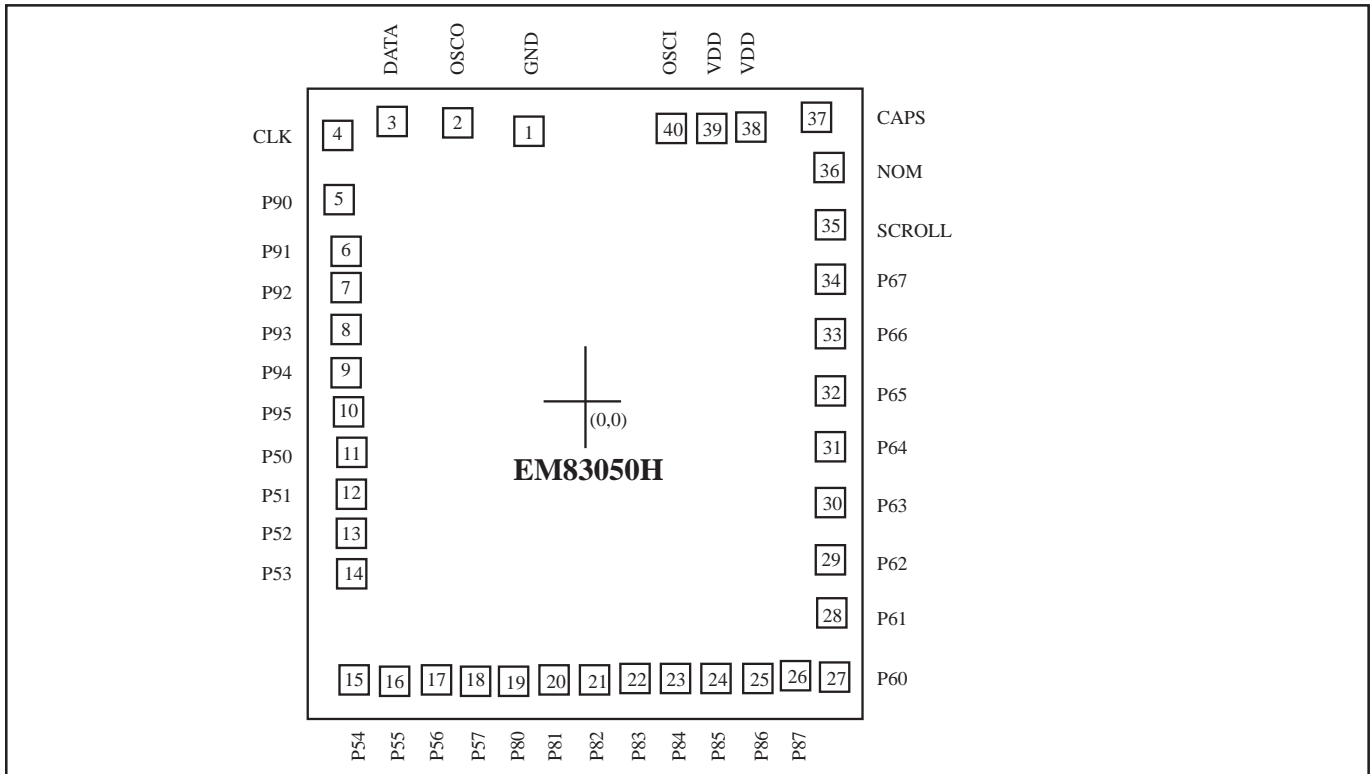

Pad No.	Symbol	X	Y
1	GND	-171.6	824.6
2	OSCO	-384.7	849.2
3	DATA	-580.9	849.2
4	CLK	-742.5	817.2
5	P90	-742.5	621.0
6	P91	-723.7	467.2
7	P92	-723.7	347.2
8	P93	-723.7	223.0
9	P94	-723.7	103.0
10	P95	-723.7	-21.2
11	P50	-715.1	-143.1
12	P51	-715.1	-263.1
13	P52	-715.1	-386.8
14	P53	-715.1	-506.8
15	P54	-707.8	-825.1
16	P55	-587.8	-825.1
17	P56	-464.1	-825.1
18	P57	-344.1	-825.1
19	P80	-220.0	-833.7
20	P81	-100.0	-833.7
21	P82	24.0	-825.1
22	P83	144.0	-825.1
23	P84	267.8	-825.1
24	P85	387.8	-825.1
25	P86	511.5	-825.1

* This specification are subject to be changed without notice.



Preliminary

Pad No.	Symbol	X	Y
26	P87	633.4	-825.1
27	P60	754.8	-825.1
28	P61	741.7	-636.9
29	P62	741.7	-470.1
30	P63	741.7	-301.3
31	P64	741.7	-134.6
32	P65	741.7	34.2
33	P66	741.7	201.0
34	P67	741.7	369.8
35	P72	741.7	536.5
36	P71	741.7	705.3
37	P70	706.8	854.2
38	VDD	504.5	824.6
39	VDD	384.5	824.6
40	OSCI	264.5	832.2

Chip Size : 1790 x 2010 μm