



## Features

- Two channel quadrature output
- Bushing or servo mount
- Square wave signal
- Index channel available
- Small size
- Resolution to 256 PPR
- CMOS and TTL compatible
- Long life
- High operating speed

# EN - Rotary Optical Encoder

## Electrical Characteristics

Output .....	2-bit gray code, Channel A leads Channel B by 90° (electrical) with clockwise rotation
Resolution .....	25 to 256 cycles per revolution
Insulation Resistance (500 VDC) .....	1,000 megohms
Electrical Travel .....	Continuous
Supply Voltage .....	5.0 VDC ±0.25 VDC*
Supply Current .....	26 mA maximum
Output Voltage	
Low Output .....	0.8 V maximum
High Output .....	4 V minimum
Output Current	
Low Output .....	25 mA minimum
Rise/Fall Time .....	200 ns (typical)
Shaft RPM (Ball Bearing) .....	3,000 rpm maximum
Power Consumption .....	136 mW maximum
Pulse Width (Electrical Degrees, Each Channel) .....	180° ±45° TYP.
Pulse Width (Index Channel) .....	360° ±90°
Phase (Electrical Degrees, Channel A to Channel B) .....	90° ±45° TYP.
Index Channel Centered on 1-1 State Combination of A and B Channels .....	0° ±45°

\*Consult factory for other voltages up to 5 VDC.

## Environmental Characteristics

Operating Temperature Range .....	-40 °C to +75 °C (-40 °F to +167 °F)
Storage Temperature Range .....	-40 °C to +85 °C (-40 °F to +185 °F)
Humidity .....	MIL-STD-202, Method 103B, Condition B
Vibration .....	5 G
Shock .....	50 G
Rotational Life	
A & C Bushings (300 rpm maximum)** .....	10,000,000 revolutions
W, S & T Bushings (3,000 rpm maximum)** .....	200,000,000 revolutions
IP Rating .....	IP 40

## Mechanical Characteristics

Mechanical Angle .....	360° Continuous
Torque (Starting and Running)	
A & C Bushings (Spring Loaded for Optimum Feel) .....	1 N-cm (1.5 oz.-in.) maximum
W, S & T Bushings (Ball Bearing Shaft Support) .....	0.07 N-cm (0.1 oz.-in.) maximum
Mounting Torque .....	1.7 to 2.0 N-cm (15 to 18 lb.-in.) maximum
Shaft End Play .....	0.30 mm (0.012 ") T.I.R. maximum
Shaft Radial Play .....	0.12 mm (0.005 ") T.I.R. maximum
Weight .....	11 gms. (0.4 oz.)
Terminals .....	Axial or radial pc pins or ribbon cable
Soldering Condition	
Manual Soldering .....	96.5Sn/3.0Ag/0.5Cu solid wire or no-clean rosin cored wire 370 °C (700 °F) max. for 3 seconds
Wave Soldering .....	96.5Sn/3.0Ag/0.5Cu solder with no-clean flux 260 °C (500 °F) max. for 5 seconds
Wash processes .....	Not recommended
Marking .....	Manufacturer's trademark, name, part number, and date code.
Hardware .....	One lockwasher and one mounting nut supplied with each encoder, except on servo mount versions.

\*\*For resolutions ≤ 128 quadrature cycles per shaft revolution.

## Quadrature Output Table

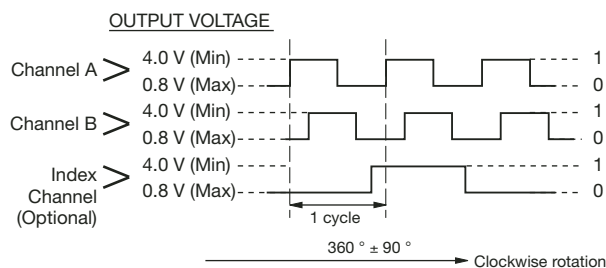

## STANDARD RESOLUTIONS AVAILABLE

(Full quadrature output cycles per shaft revolution)		
25*	125	
50*	128	
64	200	
100	256	

For Non-Standard Resolutions—Consult Factory

\* Channel B leads Channel A

## GENERAL INFORMATION

The Bourns® EN model is a self-contained rotary optical encoder. It produces a 2-bit quadrature signal which is suitable for digital systems where both magnitude and direction of adjustment must be provided. The EN encoder is ideal for use as a digital panel control or as a position sensing device in applications where long life, reliability, high resolution and precise linearity are critical.

The EN series encoder converts rotary input into electrical signals which can be used by microprocessors without A/D conversion.

Bourns encoder output signals are square wave digital pulses which do not require debounce circuitry. Both features make it possible to significantly reduce the memory overhead, wiring and wiring interconnects required by other types of control devices.

EN optical encoders offer a useful rotational life of from 10 million to 200 million shaft revolutions, making them ideal for extended service applications. The Bourns encoder is also compact and well suited for situations where the available space is limited.

# EN - Rotary Optical Encoder

# BOURNS®

## Dimensional Drawings

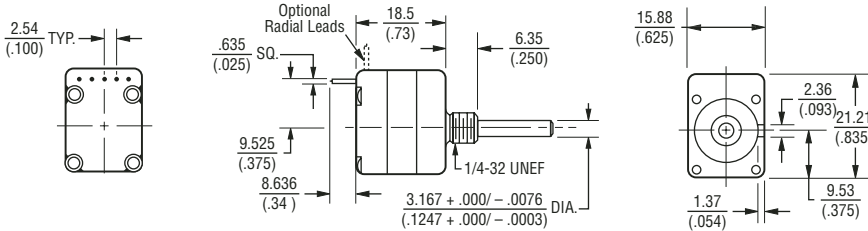

Bushing Style C

Consult factory for options not shown, including:

- Wire lead or cable options
- Connectors
- Non-standard resolutions
- Special shaft/bushing sizes and features
- Special performance characteristics
- PCB mounting bracket

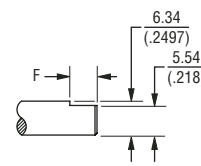
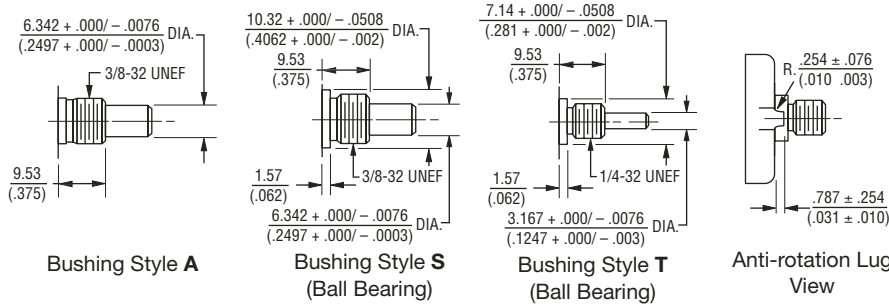

SHAFT LENGTH (DIM. F)	SHAFT FLAT LENGTH (DIM. F)
12.7 (.500)	2.54 (.100)
15.9 (.625)	5.08 (.200)
19.1 (.750)	8.25 (.325)

Shaft End Style C

## TERMINATION DIAGRAM

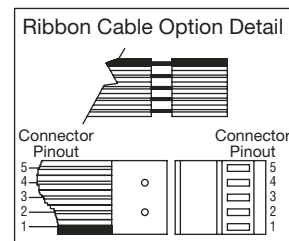
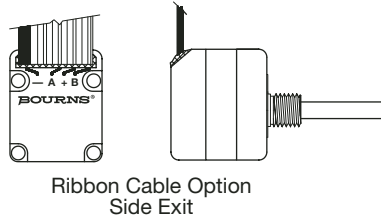
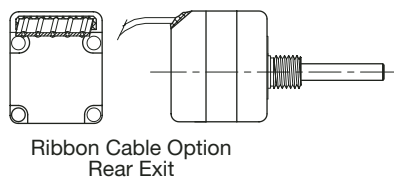
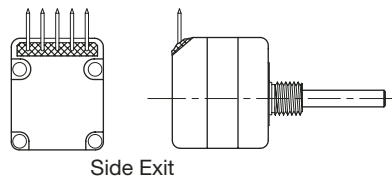
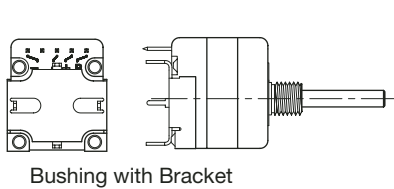
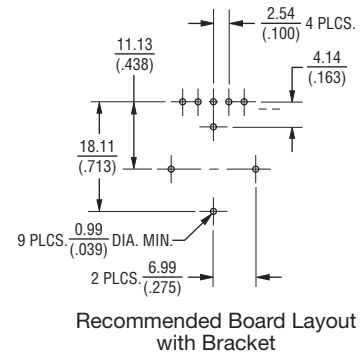
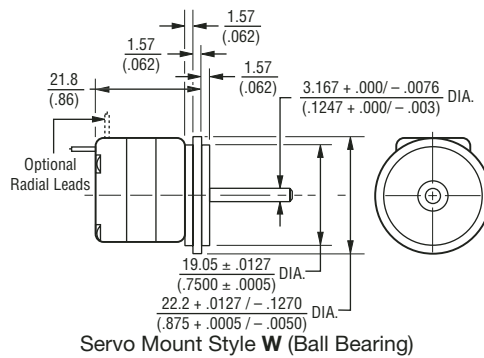
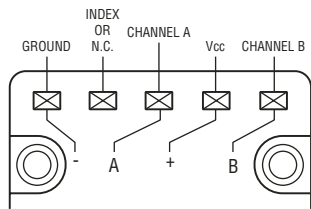

DIMENSIONS: MM (IN.)

# EN - Rotary Optical Encoder

**BOURNS®**

## How To Order

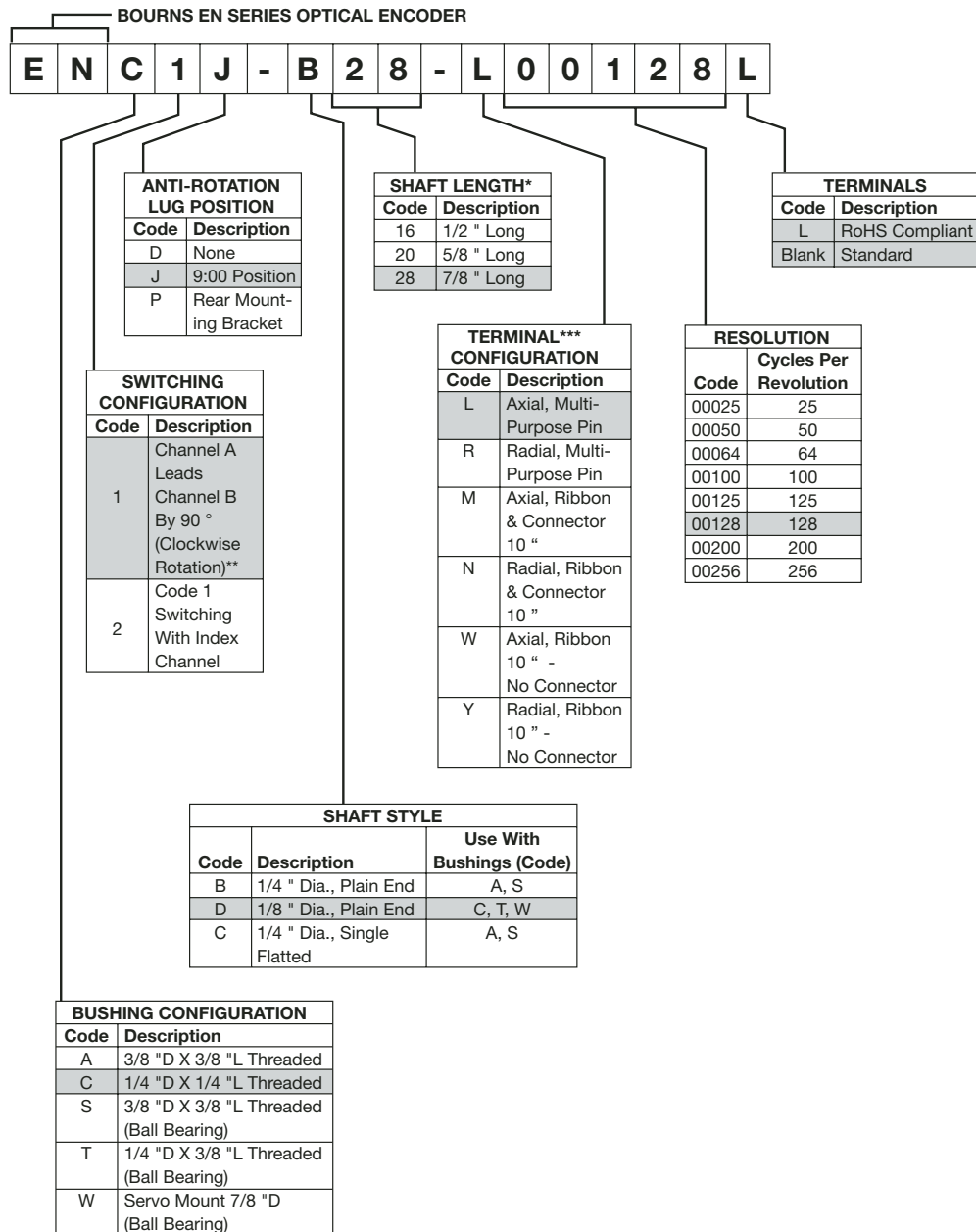

\* Shaft length measured from mounting surface.  
 \*\* 25 and 50 ppr is reversed (Channel B leads Channel A)  
 \*\*\* Standard ribbon cable is 10 " long  
 Consult factory for other lengths.