

EPC2021 – Enhancement Mode Power Transistor

 V_{DS} , 80 V $R_{DS(on)}$, 2.5 m Ω I_D , 90 A

Gallium Nitride's exceptionally high electron mobility and low temperature coefficient allows very low $R_{DS(on)}$, while its lateral device structure and majority carrier diode provide exceptionally low Q_G and zero Q_{RR} . The end result is a device that can handle tasks where very high switching frequency, and low on-time are beneficial as well as those where on-state losses dominate.

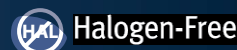
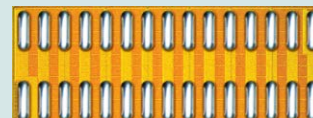

EPC2021 eGaN® FETs are supplied only in passivated die form with solder bumps. Die Size: 6.05 mm x 2.3 mm

- High Speed DC-DC Conversion
- Motor Drive
- Industrial Automation
- Synchronous Rectification
- Inrush Protection
- Class-D Audio

Maximum Ratings			
PARAMETER		VALUE	UNIT
V_{DS}	Drain-to-Source Voltage (Continuous)	80	V
	Drain-to-Source Voltage (up to 10,000 5 ms pulses at 150°C)	96	
I_D	Continuous ($T_A = 25^\circ\text{C}$, $R_{\theta JA} = 3.5^\circ\text{C/W}$)	90	A
	Pulsed (25°C , $T_{PULSE} = 300 \mu\text{s}$)	420	
V_{GS}	Gate-to-Source Voltage	6	V
	Gate-to-Source Voltage	-4	
T_J	Operating Temperature	-40 to 150	°C
T_{STG}	Storage Temperature	-40 to 150	

Thermal Characteristics			
PARAMETER		TYP	UNIT
$R_{\theta JC}$	Thermal Resistance, Junction-to-Case	0.4	°C/W
$R_{\theta JB}$	Thermal Resistance, Junction-to-Board	1.1	
$R_{\theta JA}$	Thermal Resistance, Junction-to-Ambient (Note 1)	42	

Note 1: $R_{\theta JA}$ is determined with the device mounted on one square inch of copper pad, single layer 2 oz copper on FR4 board. See http://epc-co.com/epc/documents/product-training/Appnote_Thermal_Performance_of_eGaN_FETs.pdf for details.

Static Characteristics ($T_J = 25^\circ\text{C}$ unless otherwise stated)						
PARAMETER		TEST CONDITIONS	MIN	TYP	MAX	UNIT
BV_{DSS}	Drain-to-Source Voltage	$V_{GS} = 0 \text{ V}$, $I_D = 1 \text{ mA}$	80			V
I_{DSS}	Drain-Source Leakage	$V_{GS} = 0 \text{ V}$, $V_{DS} = 64 \text{ V}$		0.1	0.7	mA
I_{GSS}	Gate-to-Source Forward Leakage	$V_{GS} = 5 \text{ V}$		1	9	mA
	Gate-to-Source Reverse Leakage	$V_{GS} = -4 \text{ V}$		0.1	0.7	mA
$V_{GS(TH)}$	Gate Threshold Voltage	$V_{DS} = V_{GS}$, $I_D = 14 \text{ mA}$	0.8	1.4	2.5	V
$R_{DS(on)}$	Drain-Source On Resistance	$V_{GS} = 5 \text{ V}$, $I_D = 29 \text{ A}$		1.8	2.5	m Ω
V_{SD}	Source-Drain Forward Voltage	$I_S = 0.5 \text{ A}$, $V_{GS} = 0 \text{ V}$		1.6		V

All measurements were done with substrate connected to source.

Dynamic Characteristics (T_j = 25°C unless otherwise stated)

PARAMETER		TEST CONDITIONS	MIN	TYP	MAX	UNIT
C _{ISS}	Input Capacitance	V _{DS} = 40 V, V _{GS} = 0 V		1650	1980	pF
C _{OSS}	Output Capacitance			970	1460	
C _{RSS}	Reverse Transfer Capacitance			20		
C _{OSS(ER)}	Effective Output Capacitance, Energy Related (Note 2)	V _{DS} = 0 to 40 V, V _{GS} = 0 V		1090		
C _{OSS(TR)}	Effective Output Capacitance, Time Related (Note 3)			1310		
R _G	Gate Resistance			0.3		Ω
Q _G	Total Gate Charge	V _{DS} = 40 V, V _{GS} = 5 V, I _D = 29 A		15	19	nC
Q _{GS}	Gate-to-Source Charge	V _{DS} = 40 V, I _D = 29 A		3.4		
Q _{GD}	Gate-to-Drain Charge			2.3		
Q _{G(TH)}	Gate Charge at Threshold			2.5		
Q _{OSS}	Output Charge	V _{DS} = 40 V, V _{GS} = 0 V		63	95	
Q _{RR}	Source-Drain Recovery Charge			0		

All measurements were done with substrate connected to source.

Note 2: C_{OSS(ER)} is a fixed capacitance that gives the same stored energy as C_{OSS} while V_{DS} is rising from 0 to 50% BV_{DSS}.

Note 3: C_{OSS(TR)} is a fixed capacitance that gives the same charging time as C_{OSS} while V_{DS} is rising from 0 to 50% BV_{DSS}.

Figure 1: Typical Output Characteristics at 25°C

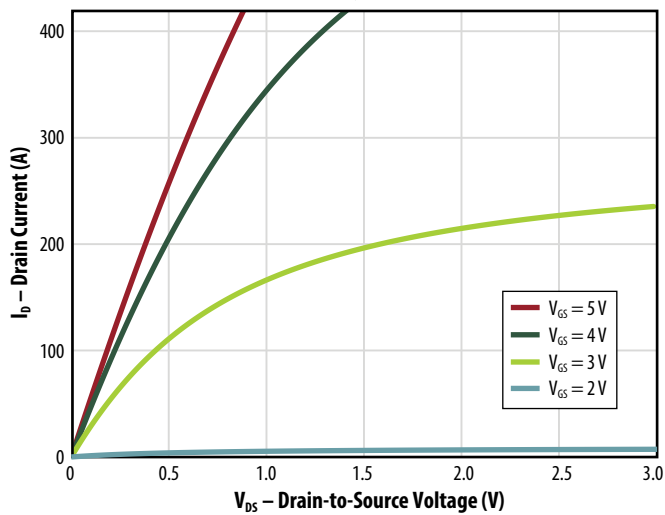

Figure 2: Transfer Characteristics

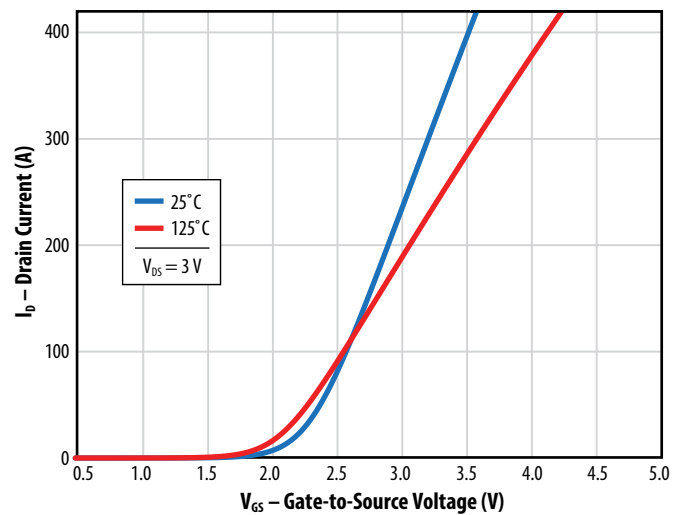

Figure 3: R_{DS(on)} vs. V_{GS} for Various Drain Currents

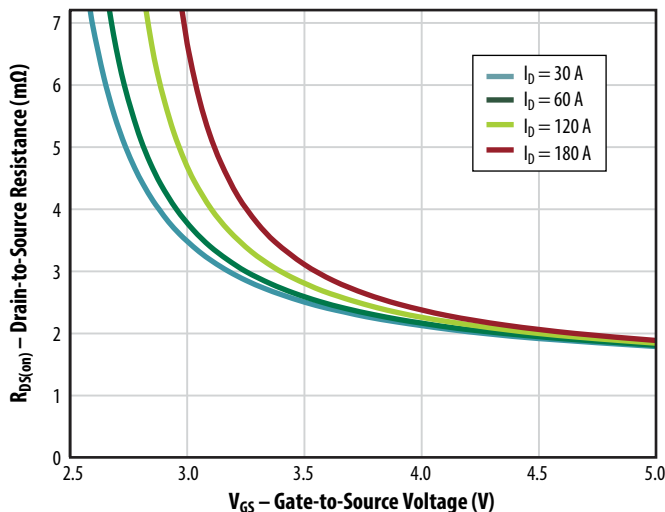

Figure 4: R_{DS(on)} vs. V_{GS} for Various Temperatures

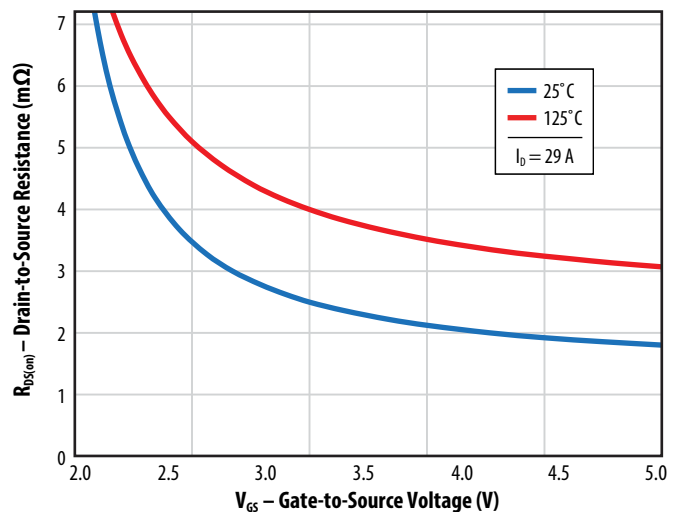

Figure 5a: Capacitance (Linear Scale)

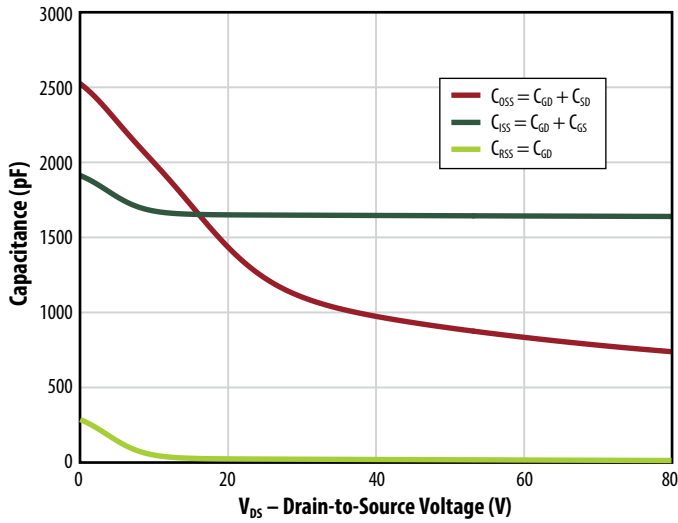

Figure 5b: Capacitance (Log Scale)

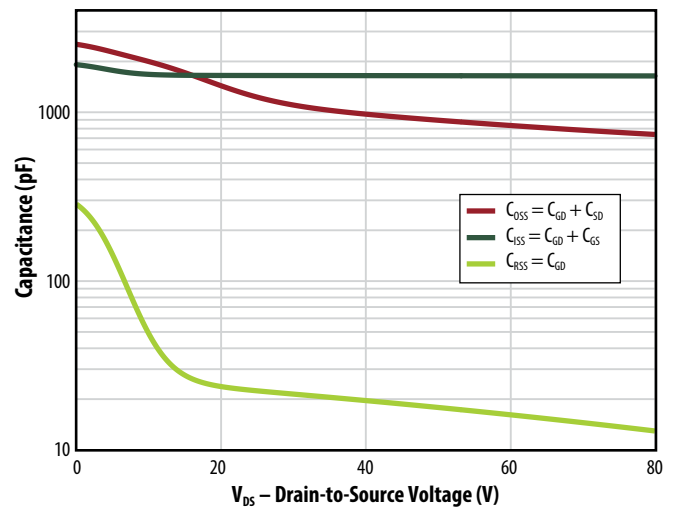

Figure 6: Gate Charge

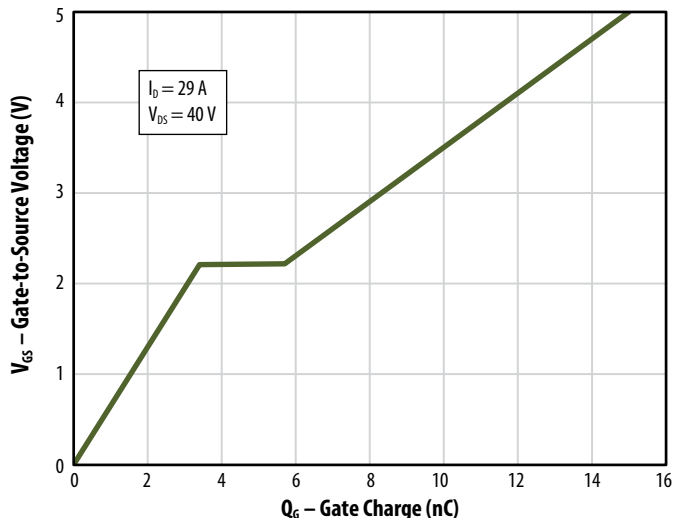

Figure 7: Reverse Drain-Source Characteristics

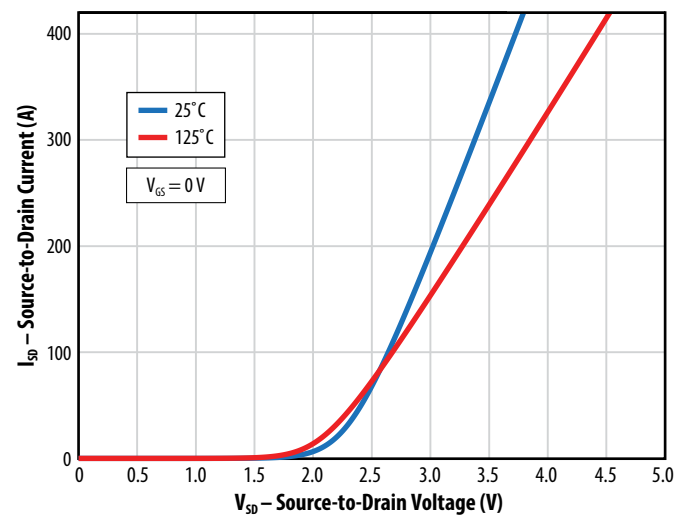

Figure 8: Normalized On-State Resistance vs. Temperature

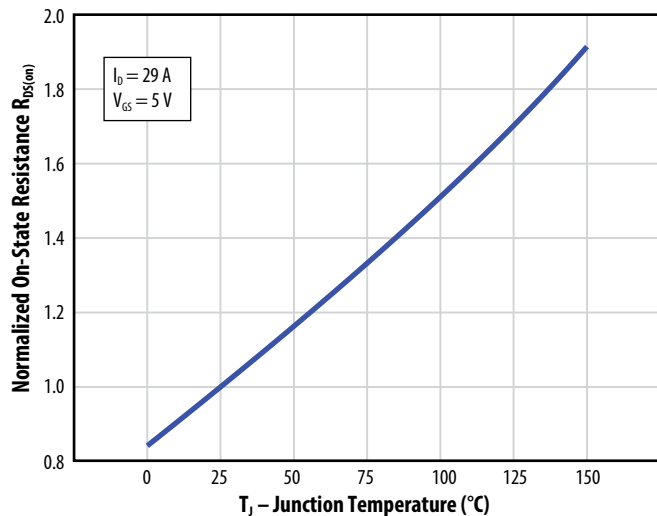
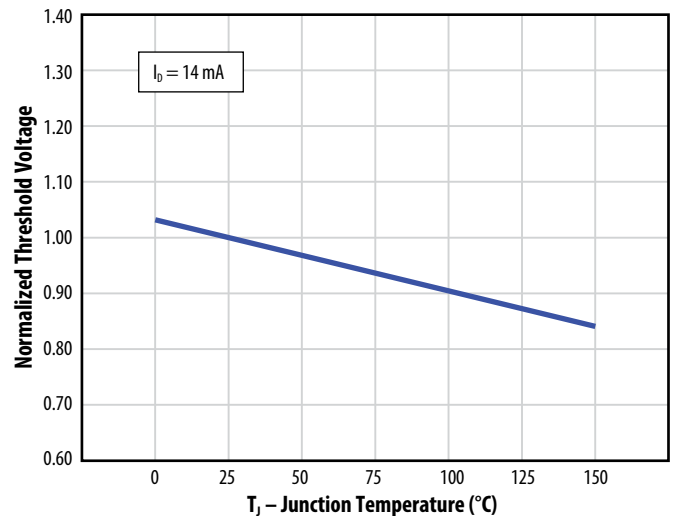

Figure 9: Normalized Threshold Voltage vs. Temperature



All measurements were done with substrate shorted to source.

Figure 10: Gate Leakage Current

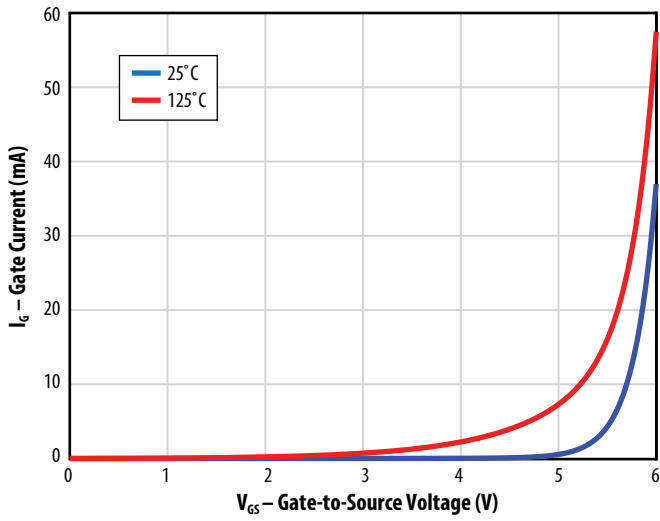

Figure 11: Safe Operating Area

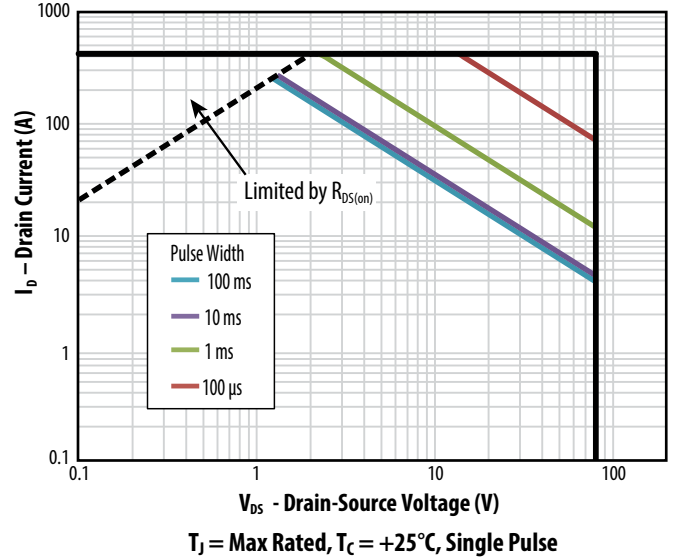
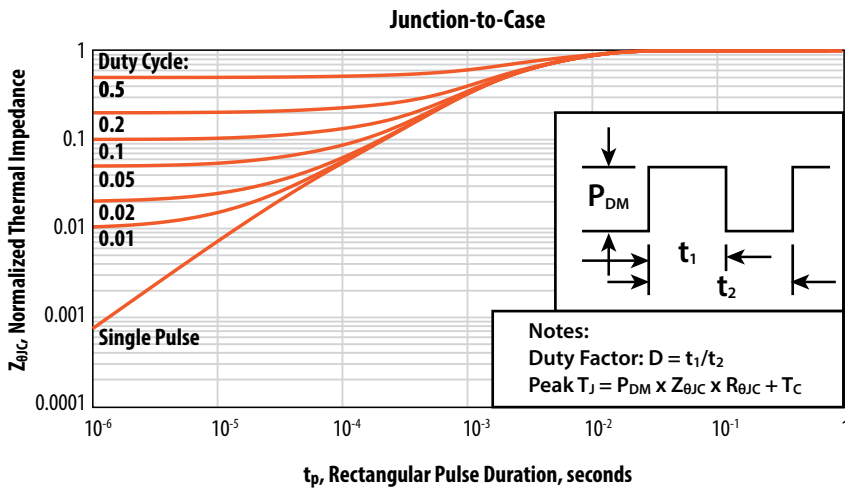
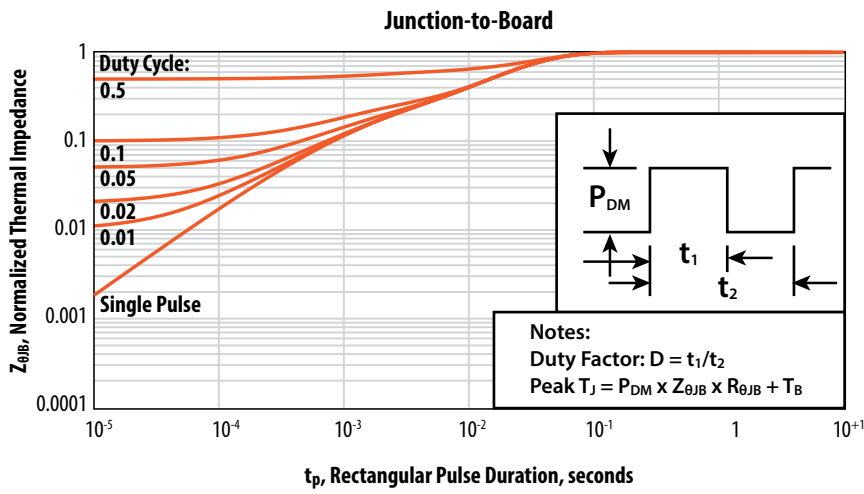
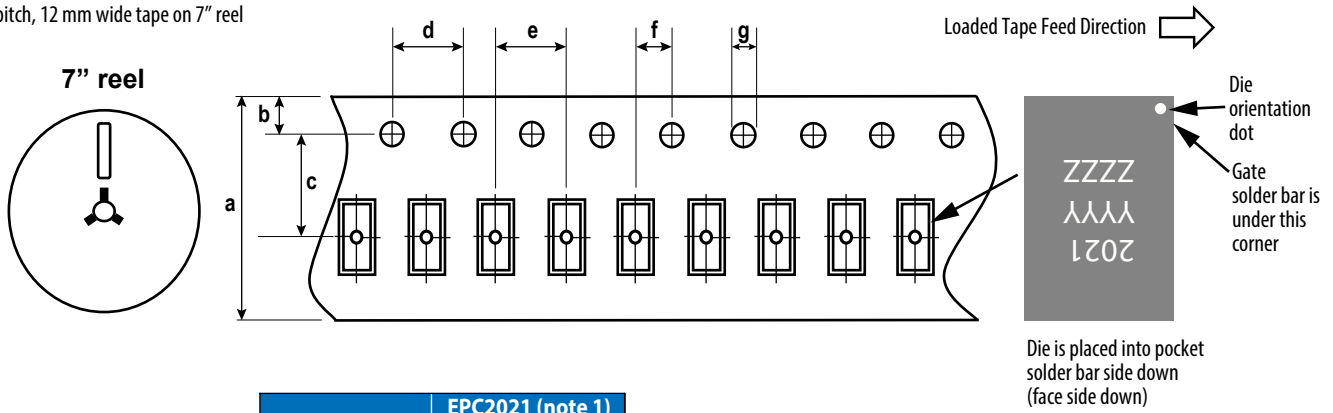

Figure 12: Transient Thermal Response Curves



TAPE AND REEL CONFIGURATION

4 mm pitch, 12 mm wide tape on 7" reel



Dimension (mm)	EPC2021 (note 1)		
	target	min	max
a	12.00	11.70	12.30
b	1.75	1.65	1.85
c (note 2)	5.50	5.45	5.55
d	4.00	3.90	4.10
e	4.00	3.90	4.10
f (note 2)	2.00	1.95	2.05
g	1.5	1.5	1.6

Note 1: MSL 1 (moisture sensitivity level 1) classified according to IPC/JEDEC industry standard.
 Note 2: Pocket position is relative to the sprocket hole measured as true position of the pocket, not the pocket hole.

DIE MARKINGS

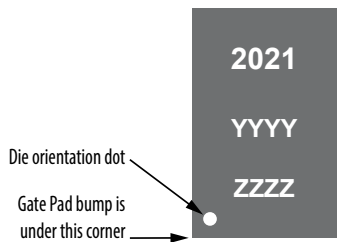

Part Number	Laser Marking		
	Part # Marking Line 1	Lot_Date Code Marking Line 2	Lot_Date Code Marking Line 3
EPC2021	2021	YYYY	ZZZZ

DIE OUTLINE

Solder Bump View

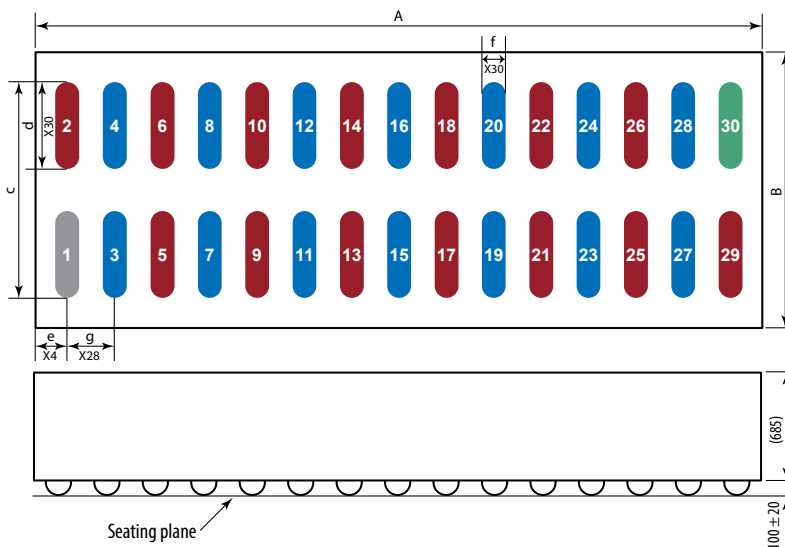

DIM	Micrometers		
	MIN	Nominal	MAX
A	6020	6050	6080
B	2270	2300	2330
c	2047	2050	2053
d	717	720	723
e	210	225	240
f	195	200	205
g	400	400	400

Pad 1 is Gate;
 Pads 2, 5, 6, 9, 10, 13, 14, 17, 18, 21, 22, 25, 26, 29 are Source;
 Pads 3, 4, 7, 8, 11, 12, 15, 16, 19, 20, 23, 24, 27, 28 are Drain;
 Pad 30 is Substrate.*

*Substrate pin should be connected to Source

RECOMMENDED LAND PATTERN
(units in μm)

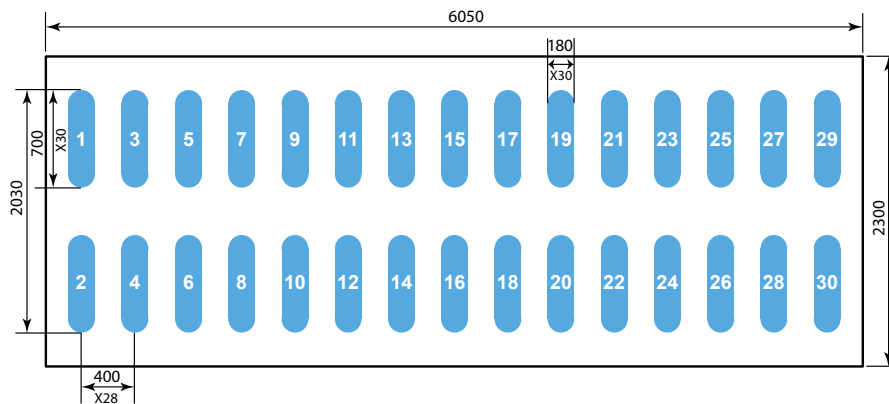

Land pattern is solder mask defined
Solder mask opening is 180 μm
It is recommended to have on-Cu trace PCB vias

Pad 1 is Gate;
Pads 2, 5, 6, 9, 10, 13, 14, 17, 18, 21, 22, 25, 26, 29 are Source;
Pads 3, 4, 7, 8, 11, 12, 15, 16, 19, 20, 23, 24, 27, 28 are Drain;
Pad 30 is Substrate.*

*Substrate pin should be connected to Source

RECOMMENDED STENCIL DRAWING
(units in μm)

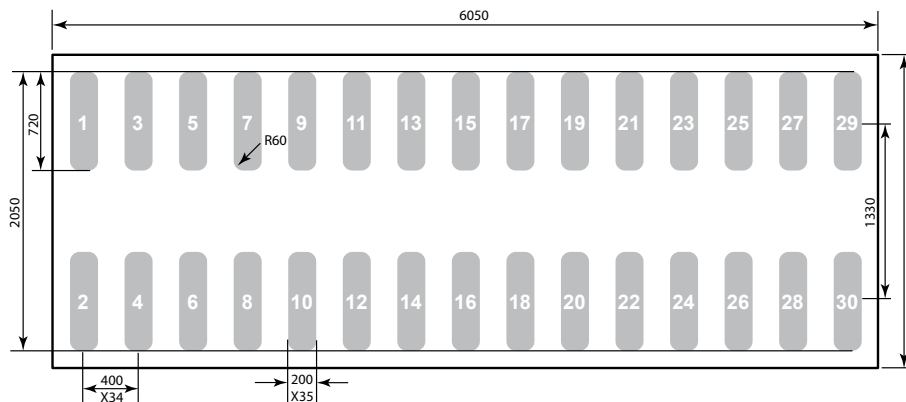

Recommended stencil should be 4 mil (100 μm) thick, must be laser cut, openings per drawing.

Intended for use with SAC305 Type 3 solder, reference 88.5% metals content.

Additional assembly resources available at <https://epc-co.com/epc/DesignSupport/AssemblyBasics.aspx>

Efficient Power Conversion Corporation (EPC) reserves the right to make changes without further notice to any products herein to improve reliability, function or design. EPC does not assume any liability arising out of the application or use of any product or circuit described herein; neither does it convey any license under its patent rights, nor the rights of others.

eGaN® is a registered trademark of Efficient Power Conversion Corporation.
EPC Patent Listing: epc-co.com/epc/AboutEPC/Patents.aspx

Information subject to change without notice.
Revised August, 2019