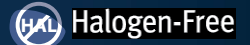

EPC2045 – Enhancement Mode Power Transistor

 $V_{DS}, 100\text{ V}$
 $R_{DS(on)}, 7\text{ m}\Omega$
 $I_D, 16\text{ A}$

Gallium Nitride's exceptionally high electron mobility and low temperature coefficient allows very low $R_{DS(on)}$, while its lateral device structure and majority carrier diode provide exceptionally low Q_G and zero Q_{RR} . The end result is a device that can handle tasks where very high switching frequency, and low on-time are beneficial as well as those where on-state losses dominate.

Maximum Ratings

PARAMETER		VALUE	UNIT
V_{DS}	Drain-to-Source Voltage (Continuous)	100	V
	Drain-to-Source Voltage (up to 10,000 5 ms pulses at 150°C)	120	
I_D	Continuous ($T_A = 25^\circ\text{C}$)	16	A
	Pulsed ($25^\circ\text{C}, T_{PULSE} = 300\ \mu\text{s}$)	130	
V_{GS}	Gate-to-Source Voltage	6	V
	Gate-to-Source Voltage	-4	
T_J	Operating Temperature	-40 to 150	°C
T_{STG}	Storage Temperature	-40 to 150	

Thermal Characteristics

PARAMETER		TYP	UNIT
$R_{\theta JC}$	Thermal Resistance, Junction-to-Case	1.4	°C/W
$R_{\theta JB}$	Thermal Resistance, Junction-to-Board	8.5	
$R_{\theta JA}$	Thermal Resistance, Junction-to-Ambient (Note 1)	64	

Note 1: $R_{\theta JA}$ is determined with the device mounted on one square inch of copper pad, single layer 2 oz copper on FR4 board. See https://epc-co.com/epc/documents/product-training/Appnote_Thermal_Performance_of_eGaN_FETs.pdf for details.

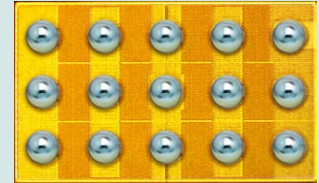

EPC2045 eGaN® FETs are supplied passivated die form with solder bumps
Die size: 2.5 mm x 1.5 mm

Applications

- Open Rack Server Architectures
- Lidar/Pulsed Power Applications
- USB-C
- Isolated Power Supplies
- Point of Load Converters
- Class D Audio
- LED Lighting
- Low Inductance Motor Drive

Benefits

- Ultra High Efficiency
- No Reverse Recovery
- Ultra Low Q_G
- Ultra Small Footprint

Static Characteristics ($T_J = 25^\circ\text{C}$ unless otherwise stated)

PARAMETER		TEST CONDITIONS	MIN	TYP	MAX	UNIT
BV_{DSS}	Drain-to-Source Voltage	$V_{GS} = 0\text{ V}, I_D = 300\ \mu\text{A}$	100			V
I_{DSS}	Drain-Source Leakage	$V_{GS} = 0\text{ V}, V_{DS} = 80\text{ V}$		40	250	μA
I_{GSS}	Gate-to-Source Forward Leakage	$V_{GS} = 5\text{ V}, T_J = 25^\circ\text{C}$		0.01	0.25	mA
	Gate-to-Source Forward Leakage [#]	$V_{GS} = 5\text{ V}, T_J = 125^\circ\text{C}$		0.1	5	mA
	Gate-to-Source Reverse Leakage	$V_{GS} = -4\text{ V}$		40	500	μA
$V_{GS(TH)}$	Gate Threshold Voltage	$V_{DS} = V_{GS}, I_D = 5\text{ mA}$	0.8	1.4	2.5	V
$R_{DS(on)}$	Drain-Source On Resistance	$V_{GS} = 5\text{ V}, I_D = 16\text{ A}$		5.6	7	m Ω
V_{SD}	Source-Drain Forward Voltage	$I_S = 0.5\text{ A}, V_{GS} = 0\text{ V}$		1.7		V

[#] Defined by design. Not subject to production test.

Dynamic Characteristics ($T_j = 25^\circ\text{C}$ unless otherwise stated)

PARAMETER		TEST CONDITIONS	MIN	TYP	MAX	UNIT
C_{ISS}	Input Capacitance [#]	$V_{DS} = 50\text{ V}, V_{GS} = 0\text{ V}$		767	1016	pF
C_{RSS}	Reverse Transfer Capacitance			3		
C_{OSS}	Output Capacitance [#]			295	443	
$C_{OSS(ER)}$	Effective Output Capacitance, Energy Related (Note 2)	$V_{DS} = 0\text{ to }50\text{ V}, V_{GS} = 0\text{ V}$		383		
$C_{OSS(TR)}$	Effective Output Capacitance, Time Related (Note 3)			500		
R_G	Gate Resistance			0.6		Ω
Q_G	Total Gate Charge [#]	$V_{DS} = 50\text{ V}, V_{GS} = 5\text{ V}, I_D = 16\text{ A}$		6	7.8	nC
Q_{GS}	Gate-to-Source Charge	$V_{DS} = 50\text{ V}, I_D = 16\text{ A}$		1.9		
Q_{GD}	Gate-to-Drain Charge			0.8		
$Q_{G(TH)}$	Gate Charge at Threshold			1.3		
Q_{OSS}	Output Charge [#]	$V_{DS} = 50\text{ V}, V_{GS} = 0\text{ V}$		25	38	
Q_{RR}	Source-Drain Recovery Charge			0		

Defined by design. Not subject to production test.

Note 2: $C_{OSS(ER)}$ is a fixed capacitance that gives the same stored energy as C_{OSS} while V_{DS} is rising from 0 to 50% BV_{DSS} .

Note 3: $C_{OSS(TR)}$ is a fixed capacitance that gives the same charging time as C_{OSS} while V_{DS} is rising from 0 to 50% BV_{DSS} .

Figure 1: Typical Output Characteristics at 25°C

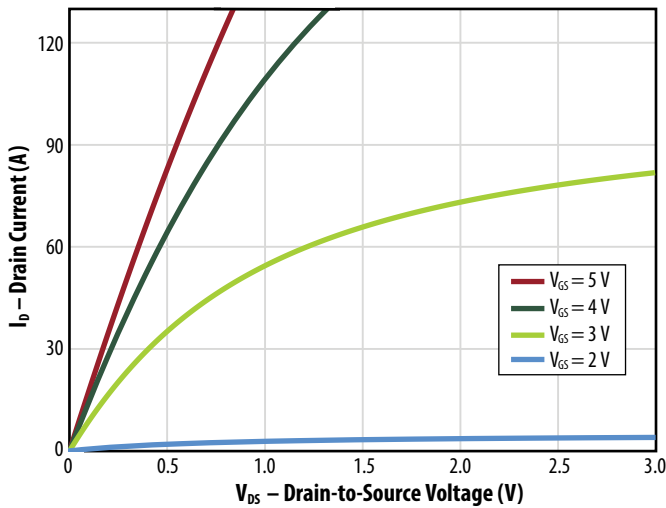

Figure 2: Transfer Characteristics

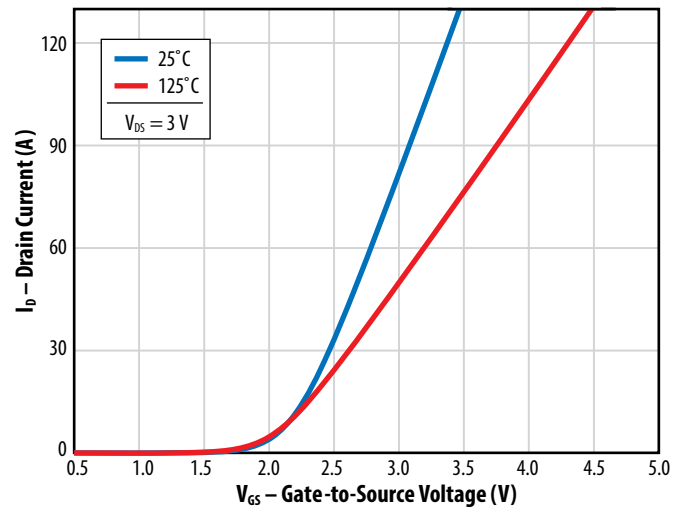

Figure 3: $R_{DS(on)}$ vs. V_{GS} for Various Drain Currents

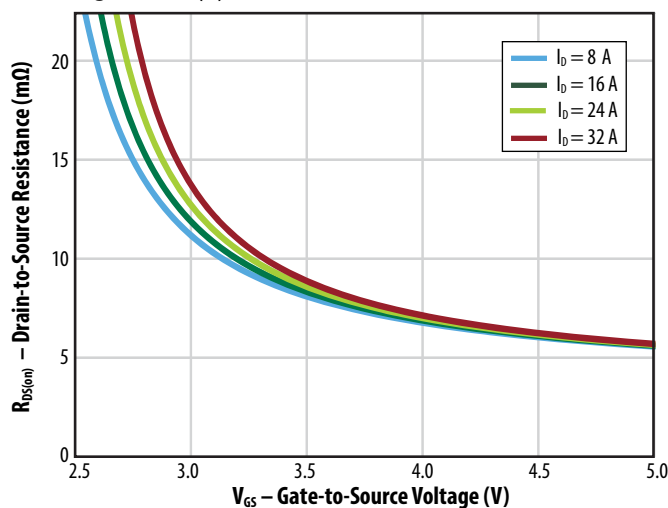

Figure 4: $R_{DS(on)}$ vs. V_{GS} for Various Temperatures

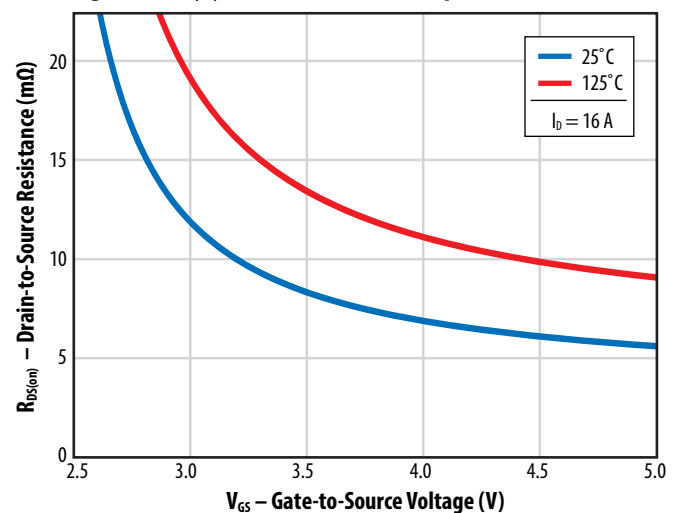

Figure 5a: Capacitance (Linear Scale)

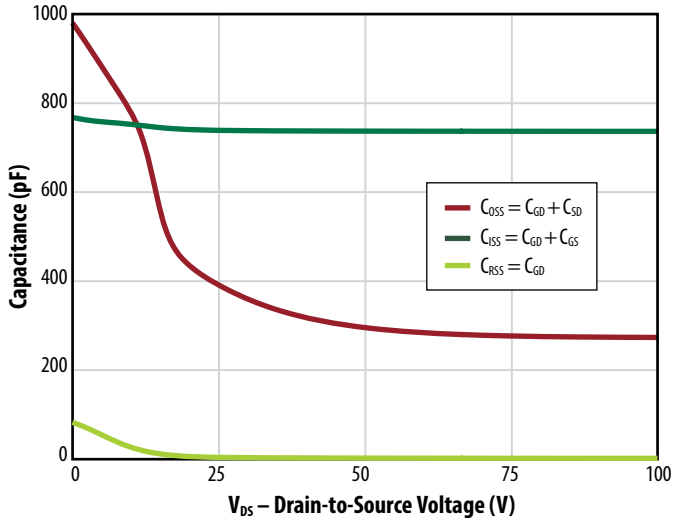

Figure 5b: Capacitance (Log Scale)

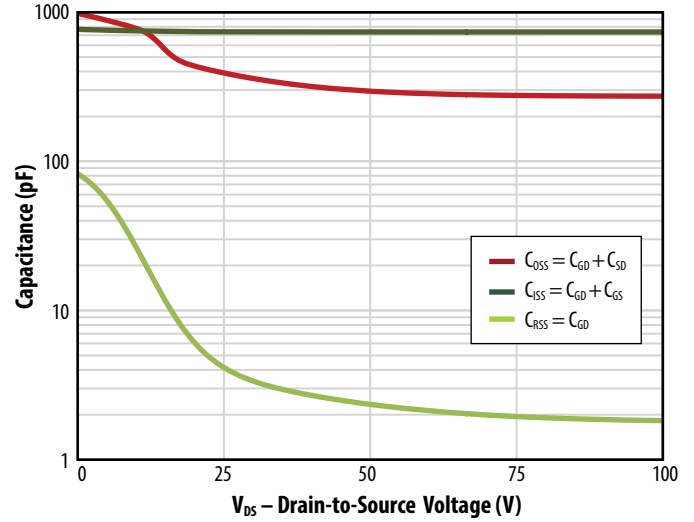

Figure 6: Output Charge and C_{OSS} Stored Energy

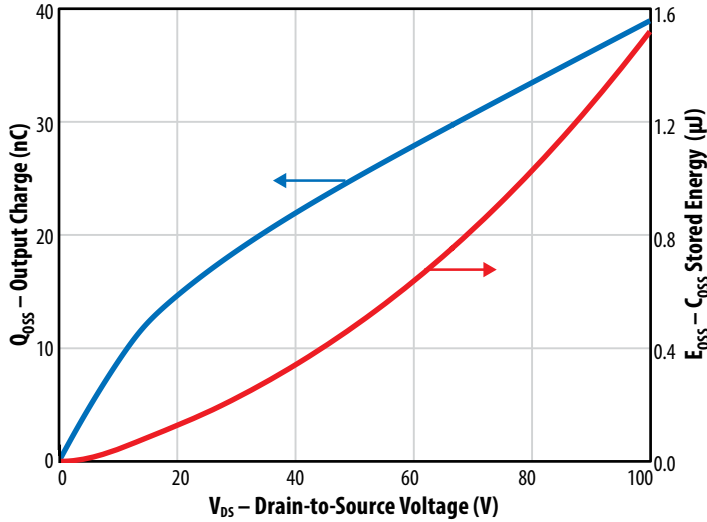

Figure 7: Gate Charge

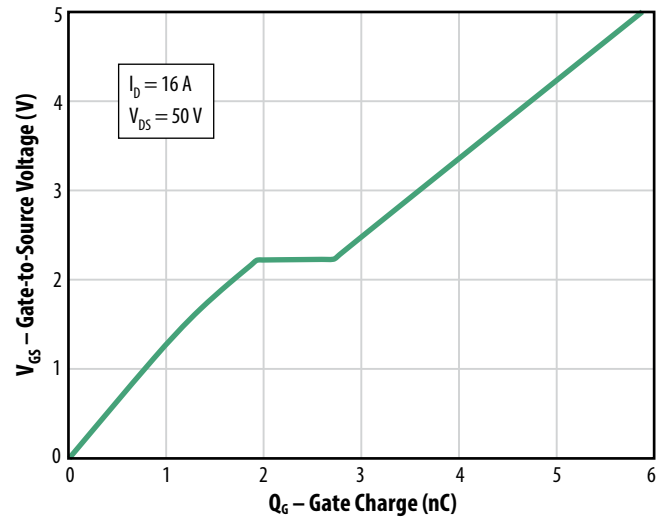

Figure 8: Reverse Drain-Source Characteristics

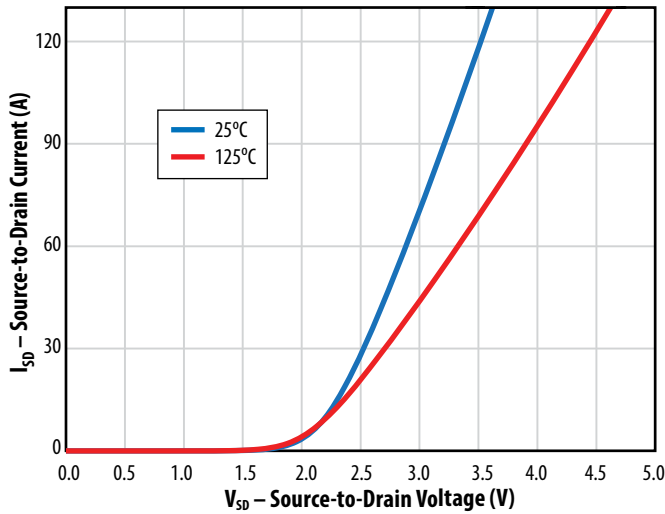

Figure 9: Normalized On-State Resistance vs. Temperature

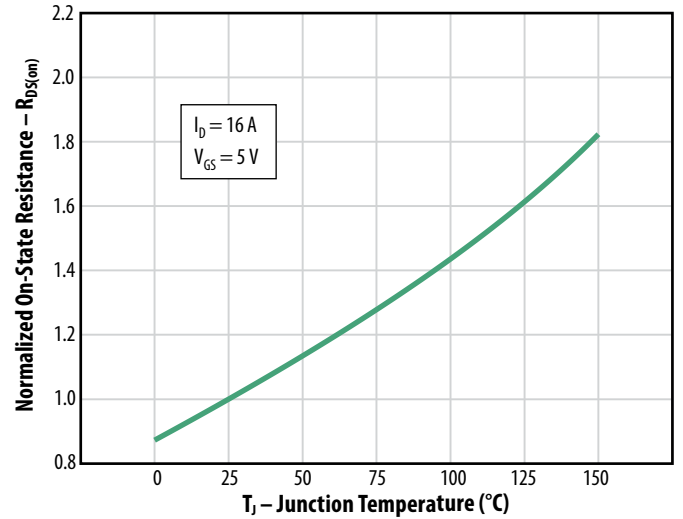

Figure 10: Normalized Threshold Voltage vs. Temperature

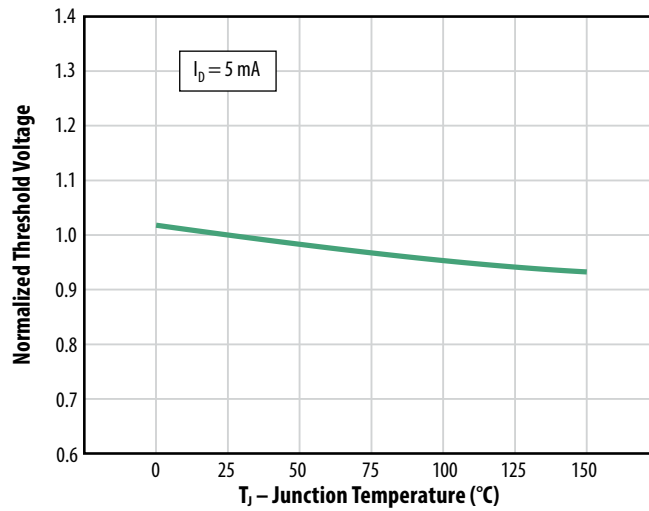

Figure 11: Transient Thermal Response Curves

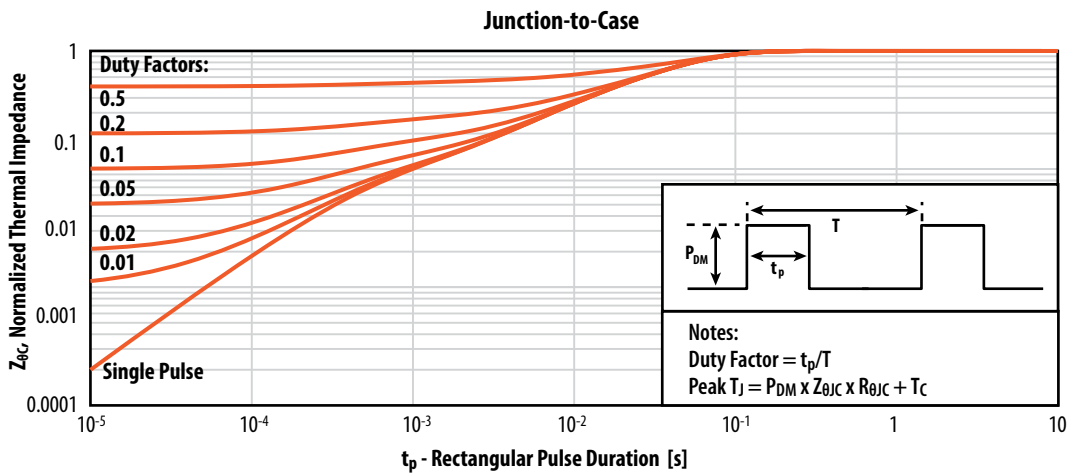
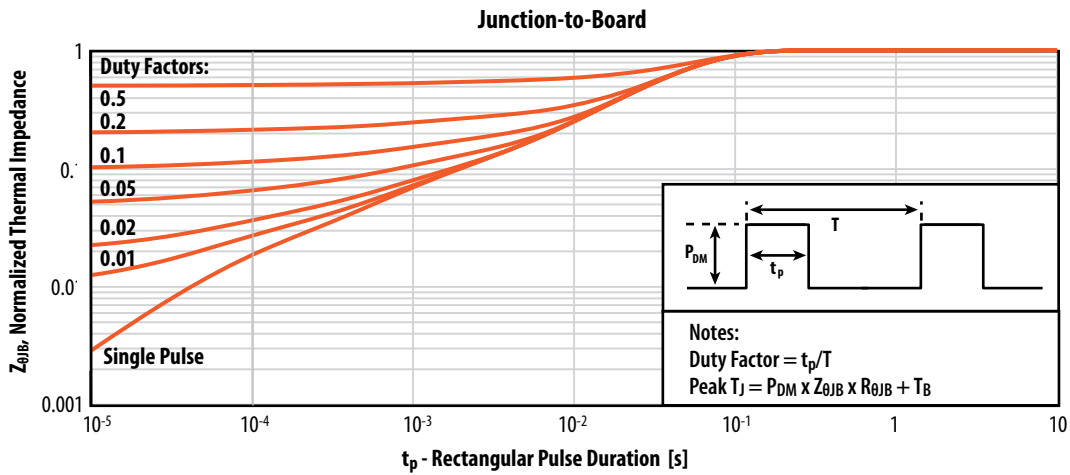
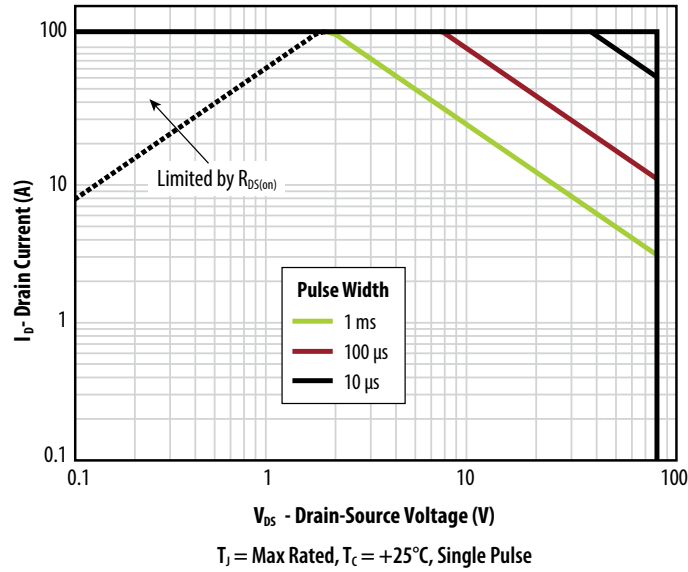
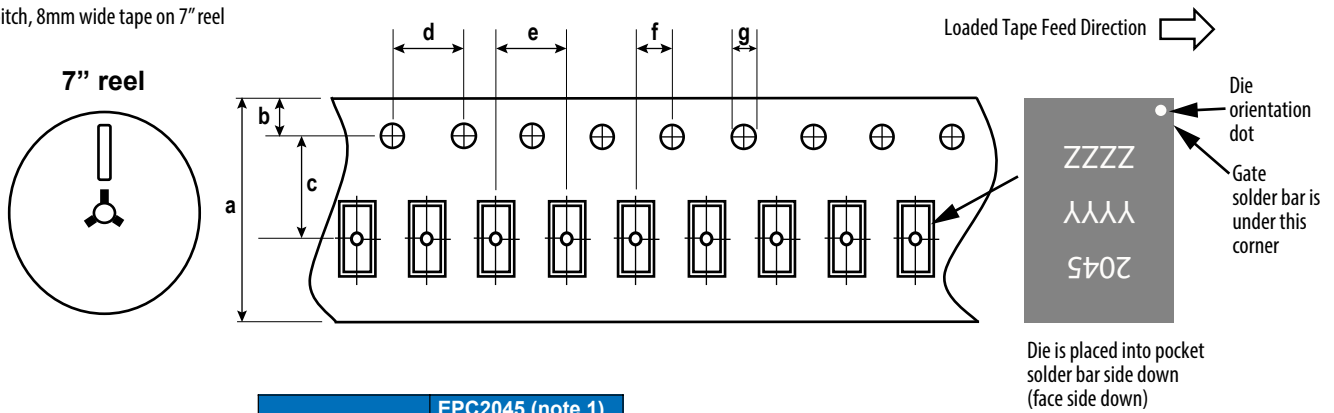

Figure 12: Safe Operating Area



TAPE AND REEL CONFIGURATION

4mm pitch, 8mm wide tape on 7" reel



EPC2045 (note 1)			
Dimension (mm)	target	min	max
a	8.00	7.90	8.30
b	1.75	1.65	1.85
c (see note)	3.50	3.45	3.55
d	4.00	3.90	4.10
e	4.00	3.90	4.10
f (see note)	2.00	1.95	2.05
g	1.5	1.5	1.6

Note 1: MSL 1 (moisture sensitivity level 1) classified according to IPC/JEDEC industry standard.
 Note 2: Pocket position is relative to the sprocket hole measured as true position of the pocket, not the pocket hole.

DIE MARKINGS

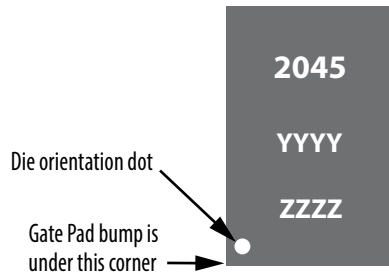

Part Number	Laser Markings		
	Part # Marking Line 1	Lot_Date Code Marking line 2	Lot_Date Code Marking Line 3
EPC2045	2045	YYYY	ZZZZ

DIE OUTLINE

Solder Bar View

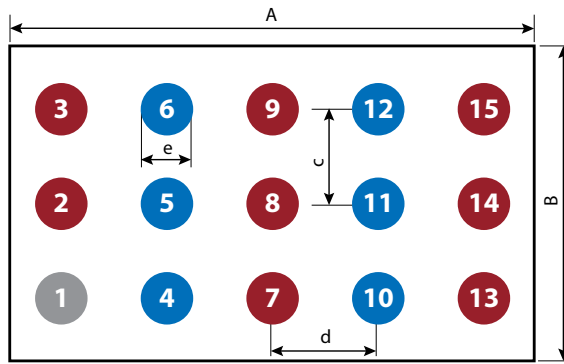

DIM	MICROMETERS		
	MIN	Nominal	MAX
A	2470	2500	2530
B	1470	1500	1530
c		450	
d		500	
e	238	264	290

Pads 1 is Gate;

Pads 2, 3, 7, 8, 9, 13, 14, 15 are Source;

Pads 4, 5, 6, 10, 11, 12 are Drain;

Side View

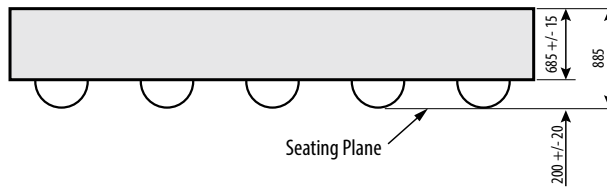

RECOMMENDED LAND PATTERN
(units in μm)

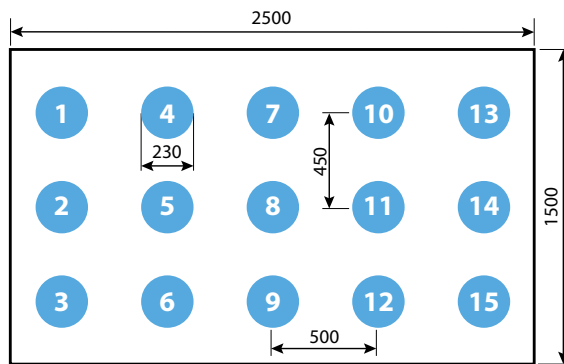

The land pattern is solder mask defined.
Copper is larger than the solder mask opening.

Pads 1 is Gate;

Pads 2, 3, 7, 8, 9, 13, 14, 15 are Source;

Pads 4, 5, 6, 10, 11, 12 are Drain;

RECOMMENDED STENCIL DRAWING
(measurements in μm)

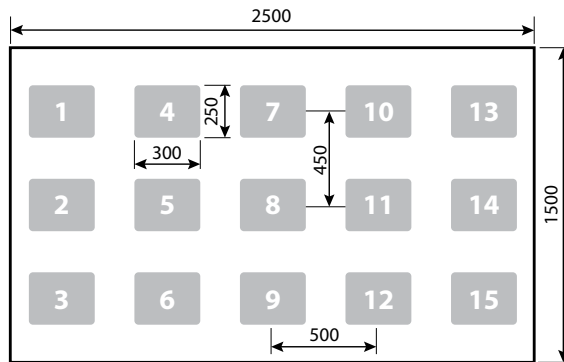

Recommended stencil should be 4 mil (100 μm) thick, laser cut. The corner has a radius of R60.

Intended for use with SAC305 Type 4 solder, reference 88.5% metals content.

Additional assembly resources available at
<https://epc-co.com/epc/DesignSupport/AssemblyBasics.aspx>

Efficient Power Conversion Corporation (EPC) reserves the right to make changes without further notice to any products herein to improve reliability, function or design. EPC does not assume any liability arising out of the application or use of any product or circuit described herein; neither does it convey any license under its patent rights, nor the rights of others.

eGaN® is a registered trademark of Efficient Power Conversion Corporation.
EPC Patent Listing: epc-co.com/epc/AboutEPC/Patents.aspx

Information subject to change without notice.
Revised March 19, 2020