



# ER300~ER308

## SUPERFAST RECOVERY RECTIFIERS

**VOLTAGE** 50 to 800 Volts **CURRENT** 3.0 Ampere

**DO-201AD** Unit: inch(mm)

### FEATURES

- Superfast recovery times-epitaxial construction.
- Low forward voltage, high current capability.
- Exceeds environmental standards of MIL-S-19500/228.
- Hermetically sealed.
- Low leakage.
- High surge capability.
- Plastic package has Underwriters Laboratories Flammability Classification 94V-O utilizing Flame Retardant Epoxy Molding Compound.
- In compliance with EU RoHS 2002/95/EC directives

### MECHANICAL DATA

- Case: Molded plastic, DO-201AD
- Terminals: Axial leads, solderable to MIL-STD-750, Method 2026
- Polarity: Color Band denotes cathode end
- Mounting Position: Any
- Weight: 0.0395 ounce, 1.122 gram

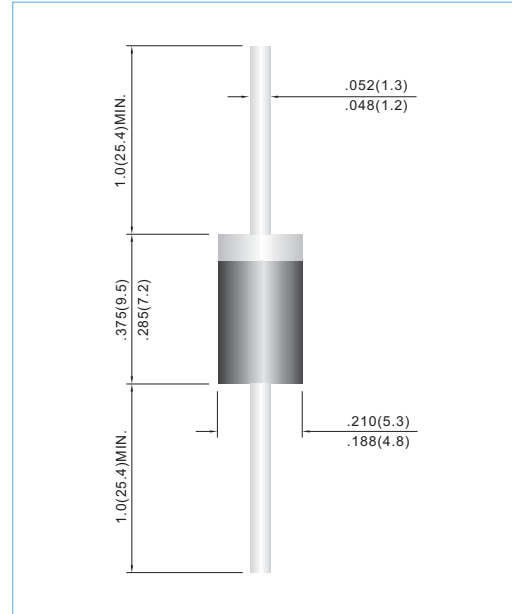

## MAXIMUM RATINGS AND ELECTRICAL CHARACTERISTICS

Ratings at 25°C ambient temperature unless otherwise specified.  
Resistive or inductive load, 60Hz.

PARAMETER	SYMBOL	ER300	ER301	ER301A	ER302	ER303	ER304	ER306	ER306A	ER308	UNITS
Maximum Recurrent Peak Reverse Voltage	$V_{RRM}$	50	100	150	200	300	400	600	700	800	V
Maximum RMS Voltage	$V_{RMS}$	35	70	105	140	210	280	420	490	560	V
Maximum DC Blocking Voltage	$V_{DC}$	50	100	150	200	300	400	600	700	800	V
Maximum Average Forward Current .375"(9.5mm) lead length at $T_A=55^\circ\text{C}$	$I_{F(AV)}$	3.0									A
Peak Forward Surge Current :8.3ms single half sine-wave superimposed on rated load(JEDEC method)	$I_{FSM}$	125									A
Maximum Forward Voltage at 3.0A DC	$V_F$	0.95			1.25		1.70	2.0	2.5		V
Maximum DC Reverse Current at $T_J=25^\circ\text{C}$ Rated DC Blocking Voltage $T_J=125^\circ\text{C}$	$I_R$					1.0		300			$\mu\text{A}$
Maximum Reverse Recovery Time(Note 1)	$t_{rr}$					35					ns
Typical Junction capacitance (Note 2)	$C_J$					35					pF
Typical Junction Resistance(Note 3)	$R_{\theta JA}$					20					$^\circ\text{C} / \text{W}$
Operating and Storage Temperature Range	$T_J, T_{STG}$					-55 to +150					$^\circ\text{C}$

NOTES:1. Reverse Recovery Test Conditions:  $I_F=.5\text{A}$ ,  $I_R=1\text{A}$ ,  $I_{rr}=.25\text{A}$   
 2. Measured at 1 MHz and applied reverse voltage of 4.0 VDC  
 3. Thermal resistance from junction to ambient and from junction to lead length 0.375"(9.5mm) P.C.B. mounted



# ER300~ER308

## RATING AND CHARACTERISTIC CURVES

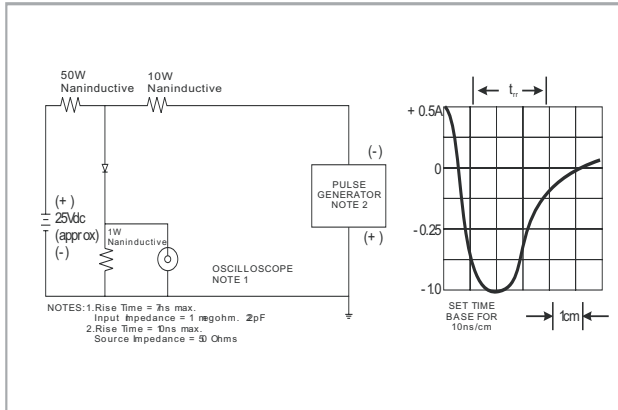

**FIG.1 REVERSE RECOVERY TIME CHARACTERISTIC AND TEST CIRCUIT DIAGRAM**

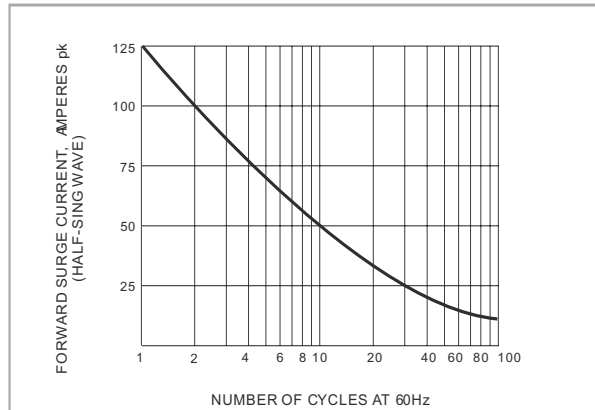

**FIG.2 MAXIMUM NON-REPEITIVE SURGE CURRENT**

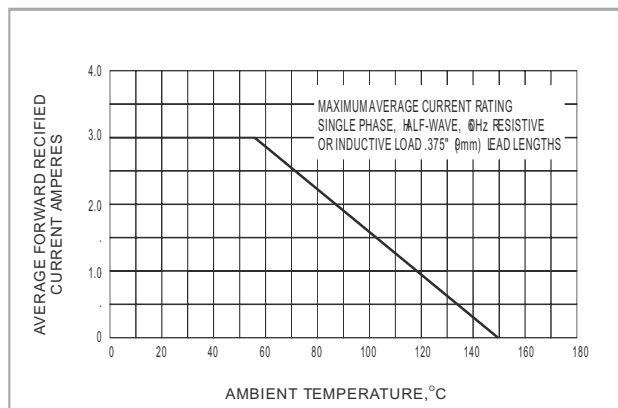

**FIG.3 MAXIMUM AVERAGE FORWARD CURRENT RATING**

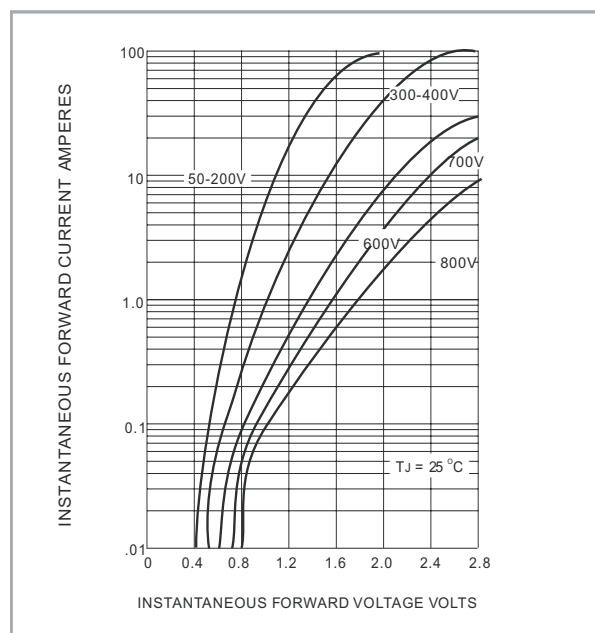

**FIG.4 TYPICAL JUNCTION CAPACITANCE**

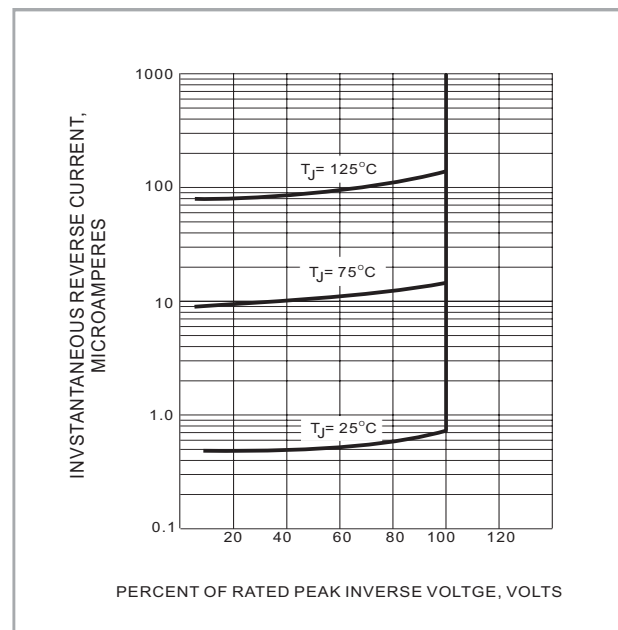

**FIG.5 TYPICAL REVERSE CHARACTERISTICS**

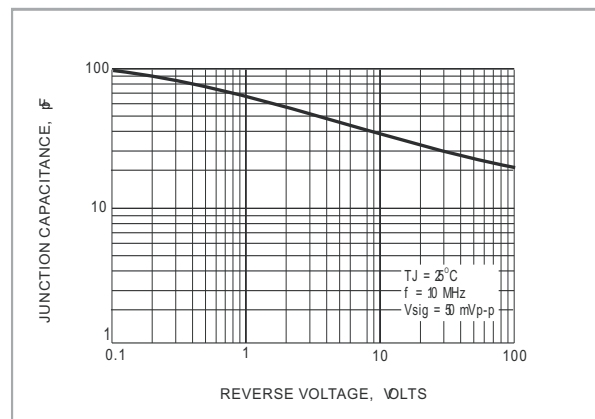

**FIG.6 TYPICAL JUNCTION CAPACITANCE**