

Transient Voltage Suppressors for ESD Protection

ESD05V02D-LC

Description

The ESD05V02D-LC is dual directional voltage rail clamp ultra-low capacitance transient voltage suppressor, electrical characteristics is positive/negative direction are symmetry, and the maximum capacitance is 0.9pF. It can be used for power supply line protection, control line protection and high-speed data line protection during static discharging, transient pulse and lightning discharge.

Feature

- ◆ Bi-directional ESD Protection of one line;
- ◆ Ultra capacitance structure: 0.5pF;
- ◆ Low clamping voltage;
- ◆ Low operating voltage 5V;
- ◆ Low leakage ;
- ◆ Provides ESD protection to IEC61000-4-2(ESD):
 - ±15kV (air discharge)
 - ±8kV (contact discharge);

Applications

- ◆ High-speed data line interface.
- ◆ 10/100/1000M Ethernet;
- ◆ Personal Digital Assistants (PDA's);
- ◆ Notebooks (DVI/HDMI)、Desktops and Servers;
- ◆ USB interface;
- ◆ Cell phone accessories;
- ◆ Digital Camera;

0201/DFN0603



Functional Diagram



Mechanical Data

- ◆ Case:0201/DFN0603 Package molded plastic.
- ◆ Terminals: Gold plated, solderable per MIL-STD-750, Method 2026.
- ◆ Polarity: Color band denotes cathode end.
- ◆ Mounting position: Any
- ◆ Reel Size : 7 inch

Mechanical Characteristics

Symbol	Parameter	Value	Units
I _{pp}	Peak pulse Current (tp=8/20us)	2.5	A
T _J	Operating Junction Temperature Range	-55 to +125	°C
T _{STG}	Storage Temperature Range	-55 to +150	°C
T _L	Soldering Temperature, t max = 10s	260	°C
V _{ESD}	IEC61000-4-2 (ESD)	Air Discharge ±15 (MIN) ContactDischarge ±8 (MIN)	KV

Transient Voltage Suppressors for ESD Protection

ESD05V02D-LC

Electrical Characteristics (@ 25°C Unless Otherwise Specified)

Characteristics	Symbol	Test Conditions	Min.	Typ.	Max.	Unit
Reverse Working Voltage	V_{RWM}	--	--	--	5	V
Reverse Breakdown Voltage	V_{BR}	$I_t=1mA$	6	--	9	V
Reverse Leakage Current	I_R	$V_{RWM}=5V ; T=25^{\circ}C$	--	--	1	μA
Positive Clamping Voltage	V_{C1}	$I_{PP}=1A , T_P=8/20\mu S ;$	--	8.5	12	V
Capacitance Between I/O And GND	C_{J2}	$V_R=0V , f=1MHz ;$	--	0.5	0.9	pF

Characteristic Curves

Fig1. 8/20 μs Pulse Waveform

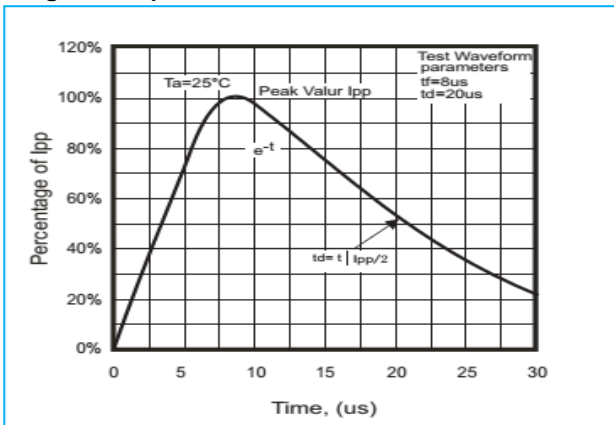

Fig2.ESD Pulse Waveform (according to IEC 61000-4-2)

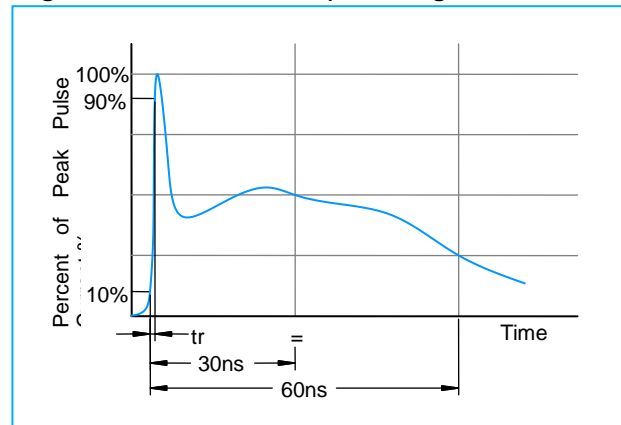

Fig3. Power Derating Curve

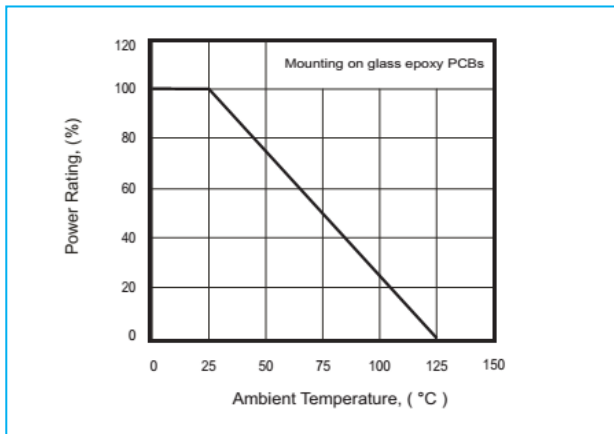
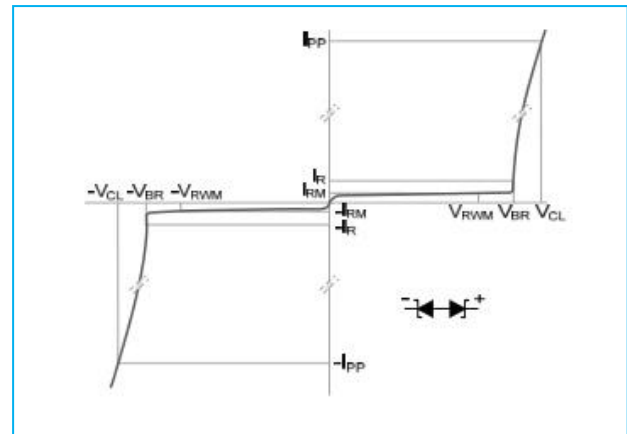

Fig4. V-I characteristics for a bidirectional ESD protection diode



Transient Voltage Suppressors for ESD Protection

ESD05V02D-LC

Characteristic Curves

Fig5. Clamping Voltage Vs. Peak Pulse Current

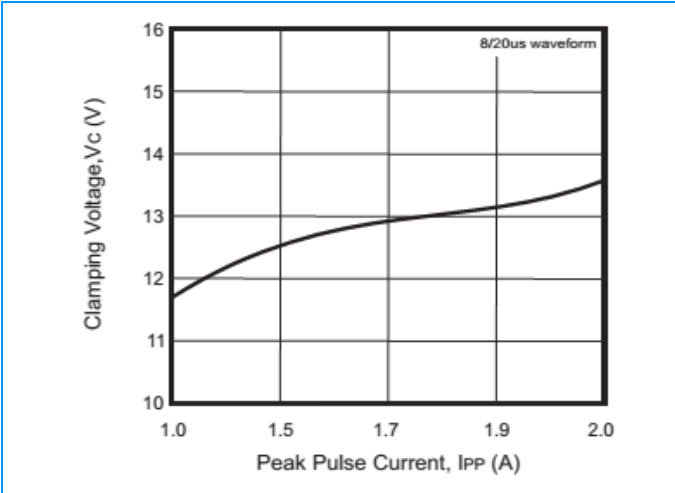
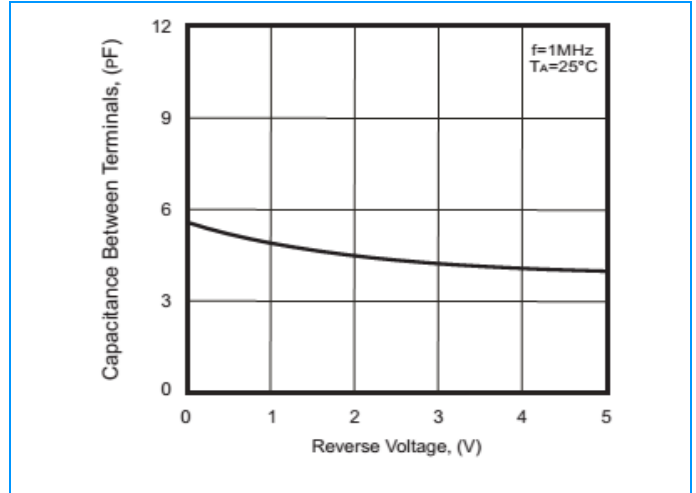
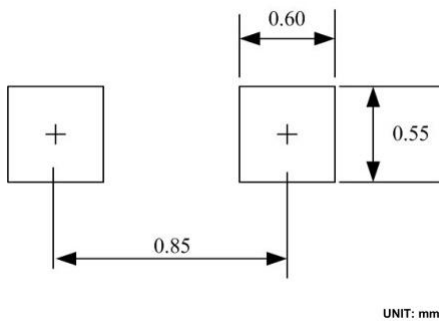

Fig6. Capacitance Between Terminals Characteristics



0201/DFN0603 Package Outline & Dimensions

LAND LAYOUT



Mechanical Details

1.0x0.6x0.50-0.62

UNIT: mm

