

Common Anode Zeners for ESD Protection

DESCRIPTION

The dual monolithic silicon Zener diodes are designed for applications requiring transient overvoltage protection capability. They are intended for use in voltage and ESD sensitive equipment such as computers, printers, business machines, communication systems, medical equipment and other applications. Their dual junction common anode design protects two separate lines using only one package. These devices ideal for situations where board space is at a premium.

MACHANICAL DATA

- ◇ SOT-23 package
- ◇ Flammability Rating: UL 94V-0
- ◇ Packaging: Tape and Reel
- ◇ High temperature soldering guaranteed: 260°C/10s
- ◇ Reel size: 7 inch

ORDERING INFORMATION

- ◇ Device: ESDxxxAL Series
- ◇ Package: SOT-23
- ◇ Material: RoHS Compliant
- ◇ Packing: Tape & Reel
- ◇ Quantity per reel: 3,000pcs

PIN CONFIGURATION

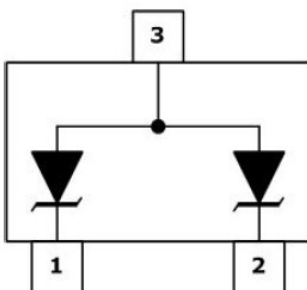

FEATURES

- ◇ SOT-23 package allows either two separate unidirectional configurations or a single bidirectional configuration.
- ◇ Working peak reverse voltage 3V to 22V
- ◇ Standard Zener breakdown voltage 5.6V to 27V
- ◇ Peak power 24 or Watts @ 1.0ms (unidirectional) per Figure 6 Waveform
- ◇ ESD Rating:
 - Class 3B (>16kV) per the Human Body Model
 - Class C (>400V) per Machine Model
- ◇ ESD Rating of IEC61000-4-2 level 4, ± 30 kV contact Discharge
- ◇ Low leakage < 5.0 μ A

APPLICATIONS

- ◇ Computers
- ◇ Printers
- ◇ Business Machines
- ◇ Communication systems
- ◇ Medical equipment

PACKAGE OUTLINE

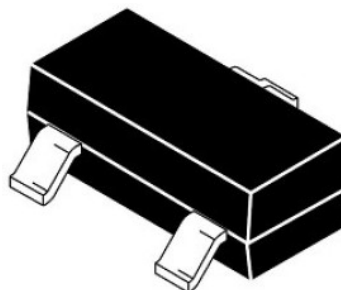

ABSOLUTE MAXIMUM RATING (Tamb=25°C, unless otherwise specified)

Symbol	Parameter	Value	Units
P _{PK}	Peak Power Dissipation @1.0ms		
	ESD5V6AL thru ESD9V1AL	24	W
	ESD12AL thru ESD27AL	40	
P _D	Total Power Dissipation	200	mW
T _{OPT}	Operating Temperature	-55/+150	°C
T _{STG}	Storage Temperature	-55/+150	°C

24 WATTS

ELECTRICAL CHARACTERISTICS (Tamb=25°C, unless otherwise specified) UNIDIRECTIONAL (Circuit tied to Pins 1 and 3 or Pins 2 to 3)

Part Number	Device Marking	V _{RWM}	I _R	V _{BR}			Z _{ZT}	Z _{ZK}		V _C		
		(V)	(μA)	(V)			(Ω)	(Ω)	(mA)	(V)	(A)	
			@ V _{RWM}	Min	Nom	Max	@ I _T	Max @I _{ZT}	Max	@ I _{ZK}	Max	@ I _{PP}
ESD5V6AL	5A6+code	3.0	5.0	5.32	5.6	5.88	20	11	1600	0.25	8.0	3.0
ESD6V2AL	6A2+code	3.0	0.5	5.89	6.2	6.51	1.0	-	-	-	8.7	2.76
ESD6V8AL	6A8+code	4.5	0.5	6.46	6.8	7.14	1.0	-	-	-	9.6	2.5
ESD9V1AL	9A1+code	6.0	0.3	8.65	9.1	9.56	1.0	-	-	-	14	1.7

V_F=0.9V Max @ I_F=10mA

40 WATTS

ELECTRICAL CHARACTERISTICS (Tamb=25°C, unless otherwise specified) UNIDIRECTIONAL (Circuit tied to Pins 1 and 3 or Pins 2 to 3)

Part Number	Device Marking	V _{RWM}	I _R	V _{BR}				V _C (note1)	
		(V)	(nA)	(V)			(mA)	(V)	(A)
			@ V _{RWM}	Min	Nom	Max	@ I _T	Max	@ I _{PP}
ESD12AL	12A+code	8.5	200	11.40	12	12.60	1.0	17	2.35
ESD15AL	15A+code	12.0	50	14.25	15	15.75	1.0	21	1.90
ESD18AL	18A+code	14.5	50	17.10	18	18.90	1.0	25	1.60
ESD20AL	20A+code	16.0	50	19	20	21	1.0	38	1.0
ESD27AL	27A+code	22.0	50	25.65	27	28.35	1.0	40	1.0

V_F=0.9V Max @ I_F=10mA

Note 1: Surge Current waveform per Figure 5

RATING AND CHARACTERISTICS CURVES (ESDxxxAL)

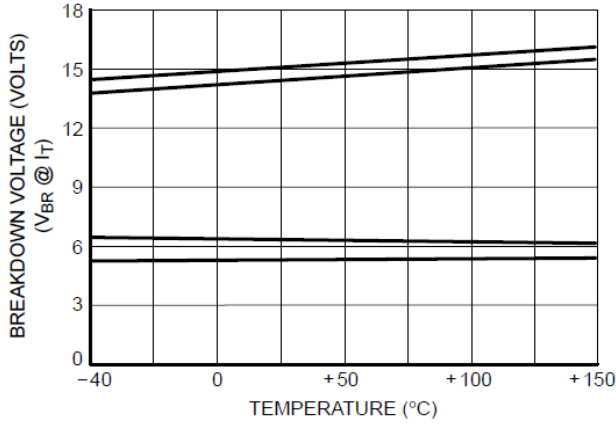

Figure 1. Typical Breakdown Voltage versus Temperature

(Upper curve for each voltage is bidirectional mode, lower curve is unidirectional mode)

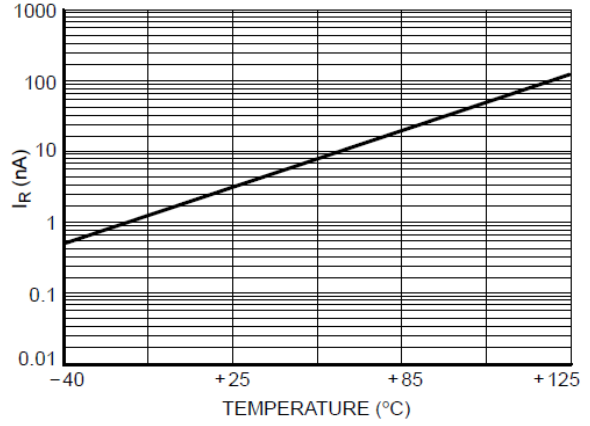

Figure 2. Typical Leakage Current versus Temperature

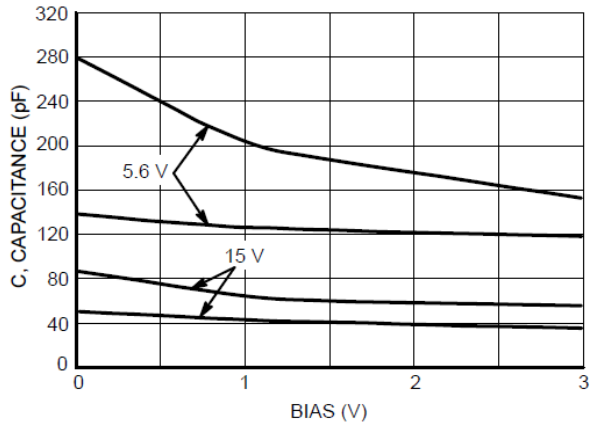

Figure 3. Typical Capacitance versus Bias Voltage

(Upper curve for each voltage is unidirectional mode, lower curve is bidirectional mode)

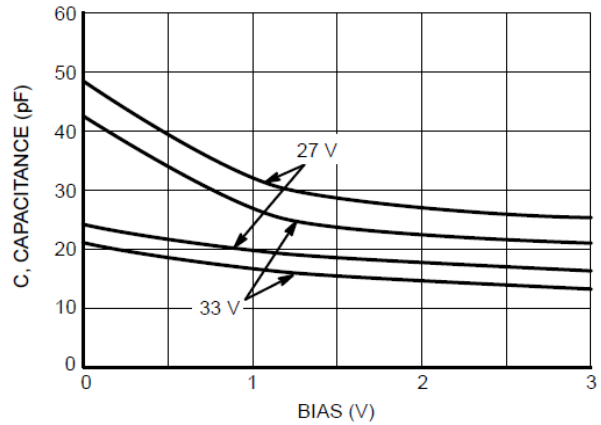

Figure 4. Typical Capacitance versus Bias Voltage

(Upper curve for each voltage is unidirectional mode, lower curve is bidirectional mode)

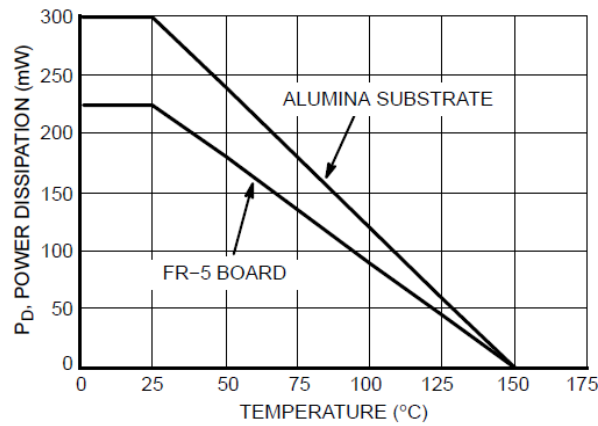

Figure 5. Steady State Power Derating Curve

RATING AND CHARACTERISTICS CURVES (ESDxxxAL)

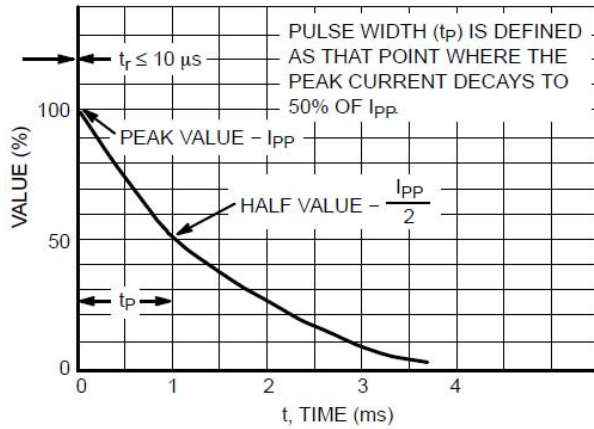

Figure 6. Pulse Waveform

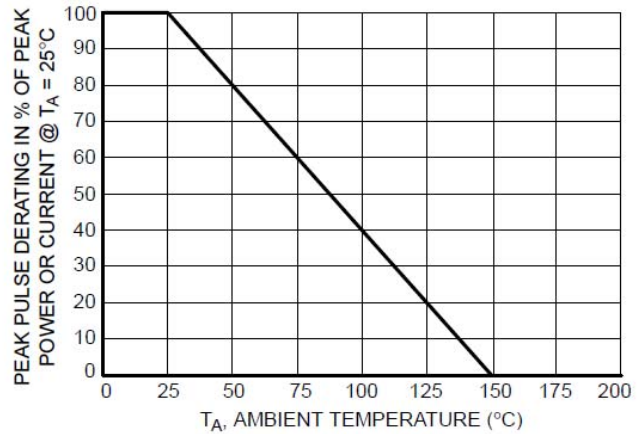

Figure 7. Pulse Derating Curve

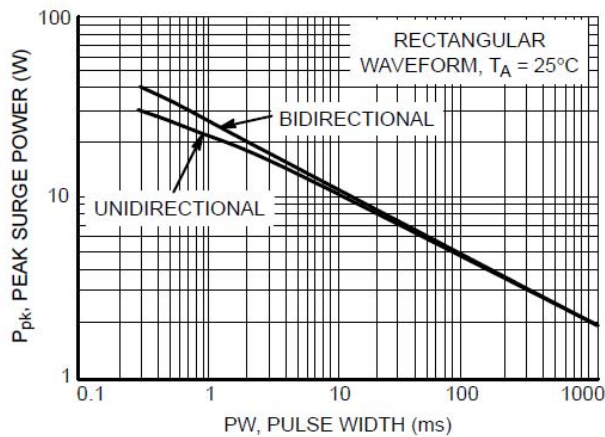

Figure 8. Maximum Non-repetitive Surge Power, P_{pk} versus PW

Power is defined as $V_{RSM} \times I_Z(pk)$ where V_{RSM} is the clamping voltage at $I_Z(pk)$.

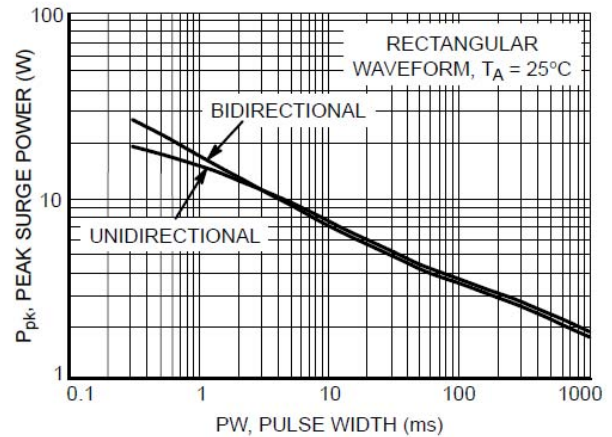
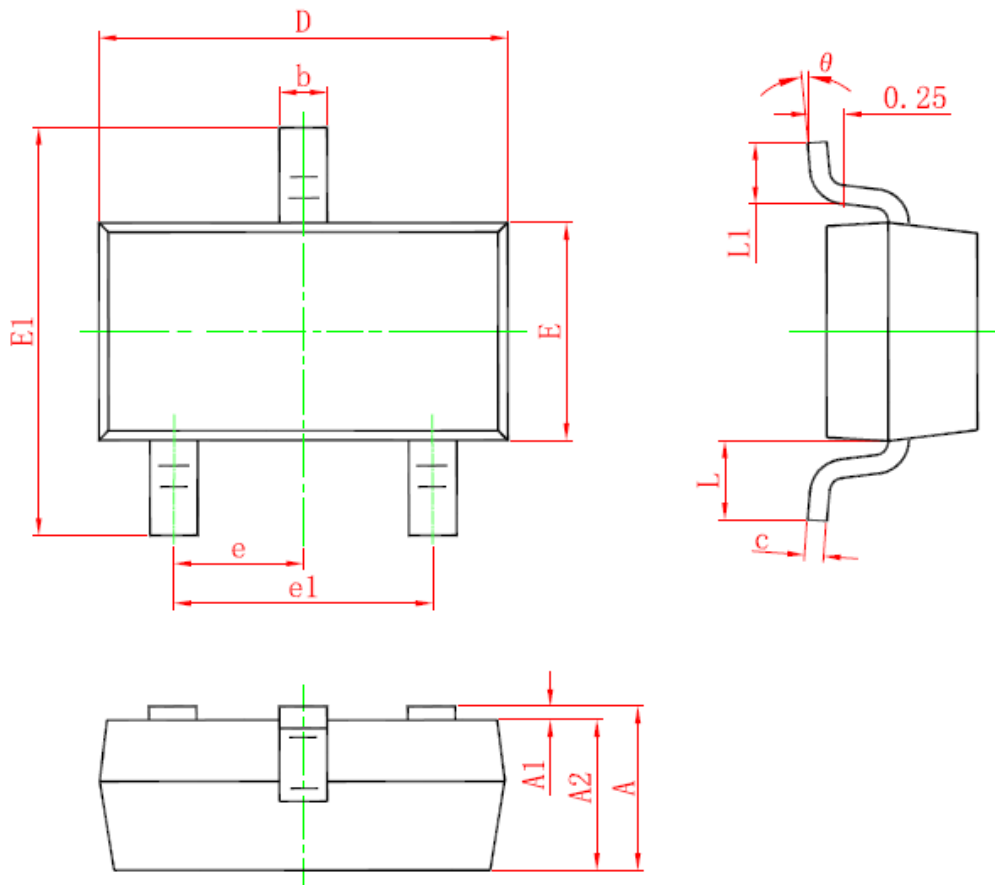

Figure 9. Maximum Non-repetitive Surge Power, $P_{pk(NOM)}$ versus PW

Power is defined as $V_Z(NOM) \times I_Z(pk)$ where $V_Z(NOM)$ is the nominal Zener voltage measured at the low test current used for voltage classification.

SOT-23 PACKAGE OUTLINE DIMENSIONS



Symbol	Dimensions In Millimeters		Dimensions In Inches	
	Min.	Max.	Min.	Max.
A	0.900	1.150	0.035	0.045
A1	0.000	0.100	0.000	0.004
A2	0.900	1.050	0.035	0.041
b	0.300	0.500	0.012	0.020
c	0.080	0.150	0.003	0.006
D	2.800	3.000	0.110	0.118
E	1.200	1.400	0.047	0.055
E1	2.250	2.550	0.089	0.100
e	0.950 TYP.		0.037 TYP.	
e1	1.800	2.000	0.071	0.079
L	0.550 REF.		0.022 REF.	
L1	0.300	0.500	0.012	0.020
θ	0°	8°	0°	8°

DISCLAIMER NOTICE

Rectron Inc reserves the right to make changes without notice to any product specification herein, to make corrections, modifications, enhancements or other changes. Rectron Inc or anyone on its behalf assumes no responsibility or liability for any errors or inaccuracies. Data sheet specifications and its information contained are intended to provide a product description only. "Typical" parameters which may be included on RECTRON data sheets and/ or specifications can and do vary in different applications and actual performance may vary over time. Rectron Inc does not assume any liability arising out of the application or use of any product or circuit.

Rectron products are not designed, intended or authorized for use in medical, life-saving implant or other applications intended for life-sustaining or other related applications where a failure or malfunction of component or circuitry may directly or indirectly cause injury or threaten a life without expressed written approval of Rectron Inc. Customers using or selling Rectron components for use in such applications do so at their own risk and shall agree to fully indemnify Rectron Inc and its subsidiaries harmless against all claims, damages and expenditures.