

Ultra-Low Capacitance TVS Diode

- ESD / transient protection of high-speed data lines exceeding
IEC61000-4-2 (ESD): ± 20 kV (air / contact)
IEC61000-4-4 (EFT): 2.5 kV / 50 A (5/50 ns)
IEC61000-4-5 (surge): 3 A (8/20 μ s)
- Extremely small form factor down to 0.62 x 0.32 x 0.31 mm³
- Reverse working voltage: 5.3 V max.
- Very low reverse current: < 10 nA typ.
- Extremely low capacitance: 0.4 pF typ.
- Very low clamping voltage: 12 V typ. at positive transients, 4 V typ. at negative transients
- Very low series inductance down to 0.2 nH typ.
- Pb-free (RoHS compliant) package

Applications

- USB 2.0, 10/100/1000 Ethernet, Firewire, DVI, HDMI, S-ATA
- Mobile communication
- Consumer products (STB, MP3, DVD, DSC...)
- LCD displays, camera
- Notebooks and desktop computers, peripherals

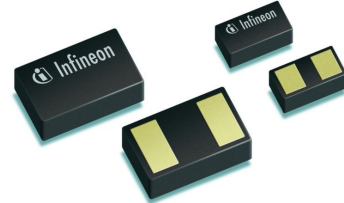

ESD5V3U1U-02LS
ESD5V3U1U-02LRH

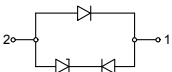

Type	Package	Configuration	Marking
ESD5V3U1U-02LRH	TSLP-2-7	1 line, uni-directional	E5
ESD5V3U1U-02LS	TSSLP-2-1	1 line, uni-directional	L

Maximum Ratings at $T_A = 25^\circ\text{C}$, unless otherwise specified

Parameter	Symbol	Value	Unit
ESD (air / contact) discharge ¹⁾	V_{ESD}	20	kV
Peak pulse current ($t_p = 8 / 20 \mu\text{s}$) ²⁾	I_{pp}	3	A
Operating temperature range	T_{op}	-55...125	°C
Storage temperature	T_{stg}	-65...150	

Electrical Characteristics at $T_A = 25^\circ\text{C}$, unless otherwise specified

Parameter	Symbol	Values			Unit
		min.	typ.	max.	
Characteristics					
Reverse working voltage	V_{RWM}	-	-	5.3	V
Breakdown voltage $I_{\text{(BR)}} = 1 \text{ mA}$, from pin 1 to 2	$V_{\text{(BR)}}$	6	-	-	
Reverse current $V_{\text{R}} = 5.3 \text{ V}$, from pin 1 to 2	I_{R}	-	< 10	100	nA
Clamping voltage $I_{\text{PP}} = 1 \text{ A}$, $t_p = 8/20 \mu\text{s}^2$, from pin 1 to 2 $I_{\text{PP}} = 3 \text{ A}$, $t_p = 8/20 \mu\text{s}^2$, from pin 1 to 2	V_{CL}	-	10 12	13 15	V
Forward clamping voltage $I_{\text{PP}} = 1 \text{ A}$, $t_p = 8/20 \mu\text{s}^2$, from pin 2 to 1 $I_{\text{PP}} = 3 \text{ A}$, $t_p = 8/20 \mu\text{s}^2$, from pin 2 to 1	V_{FC}	-	2 4	4 6	
Line capacitance ³⁾ $V_{\text{R}} = 0 \text{ V}$, $f = 1 \text{ MHz}$	C_{T}	-	0.4	0.6	
Series inductance ESD5V3U1U-02LS ESD5V3U1U-02LRH	L_{S}	-	0.2 0.4	- -	nH

¹⁾ V_{ESD} according to IEC61000-4-2

²⁾ I_{pp} according to IEC61000-4-5

³⁾ Total capacitance line to ground

Clamping voltage, $V_{cl} = f(I_{pp})$

$t_p = 8 / 20 \mu s$, from pin 1 to 2

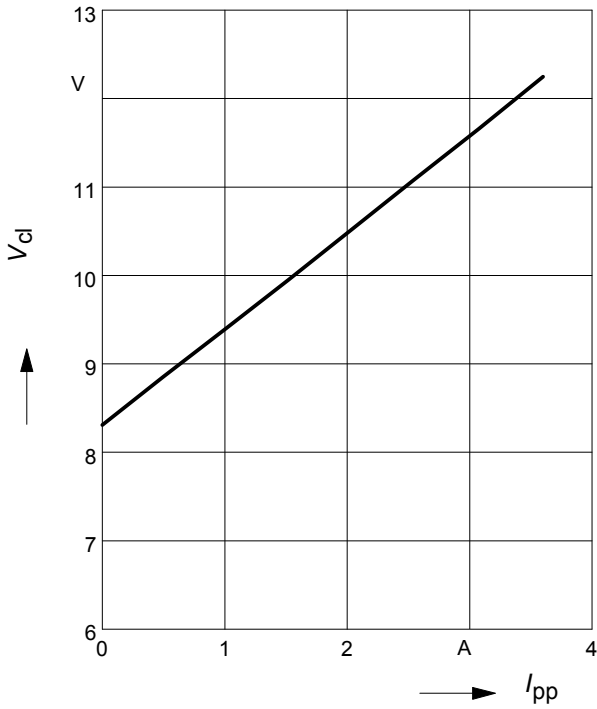

Forward clamping voltage $V_{FC} = f(I_{PP})$

$t_p = 8 / 20 \mu s$, from pin 2 to 1

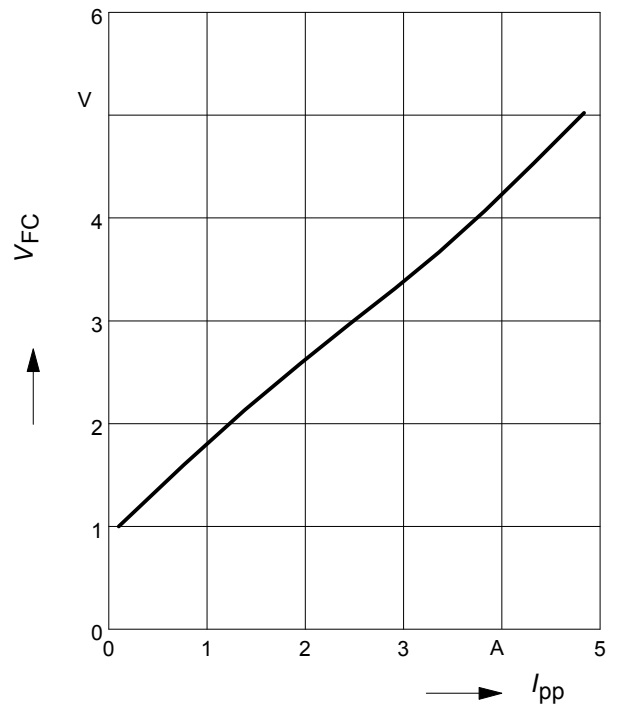

Reverse current $I_R = f(T_A)$

$V_R = 5.3 V$, from pin 1 to 2

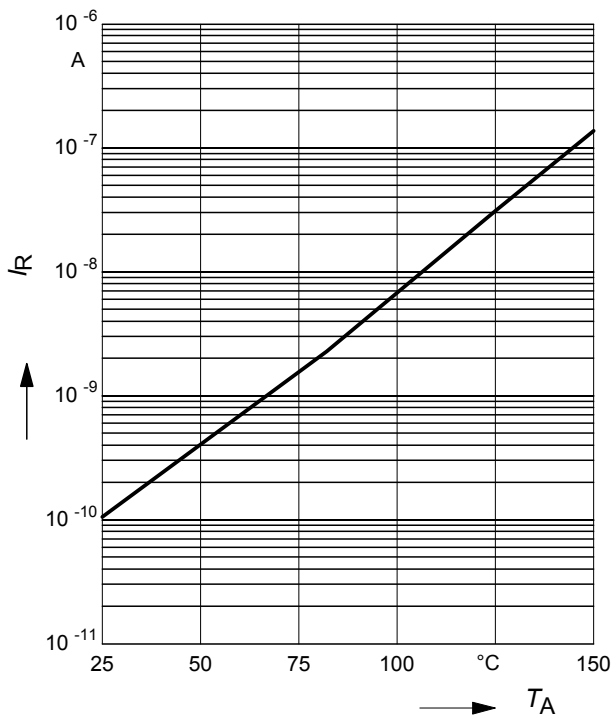

Line capacitance $C_T = f(V_R)$

$f = 1 MHz$, from pin 1 to 2

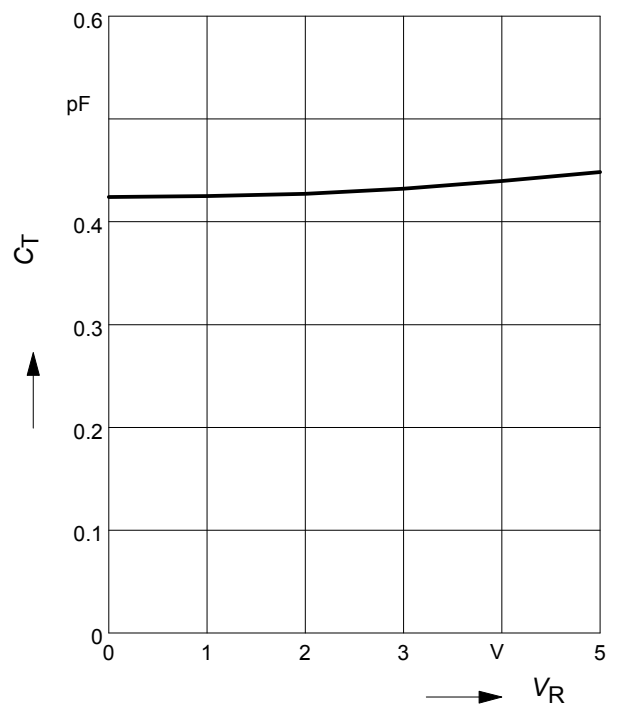

Line capacitance $C_T = f(f)$

$V_R =$ parameter, from pin 1 to 2

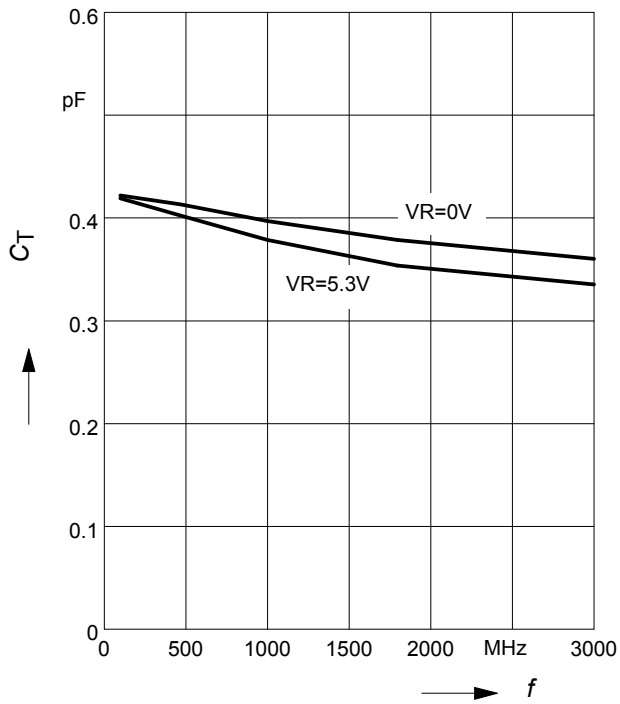

Line capacitance $C_T = f(T_A)$

$V_R = 0 V, f = 1 MHz$

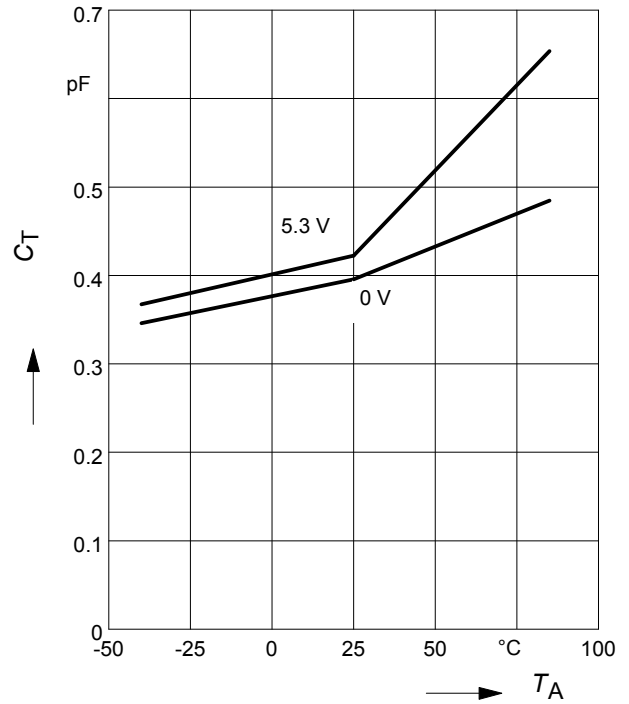

Application example ESD5V3U1U...

1-channel, uni-directional

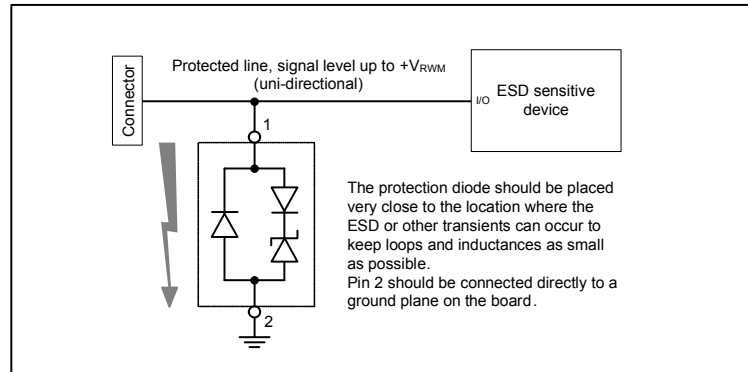

Package Outline

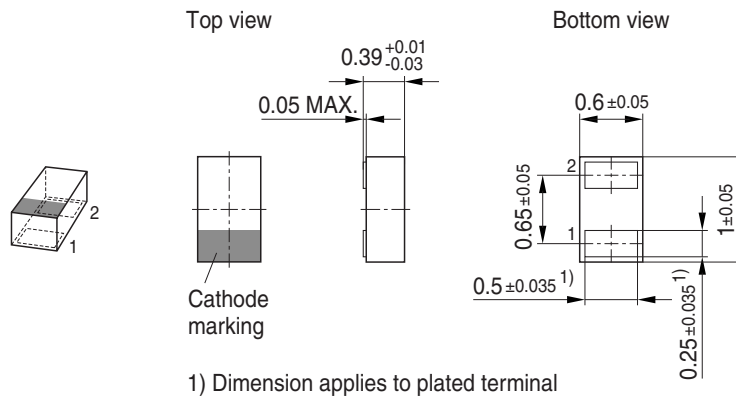

Foot Print

For board assembly information please refer to Infineon website "Packages"

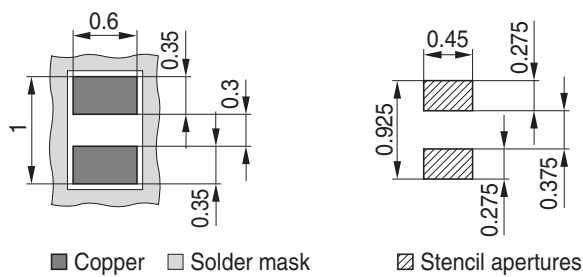

Marking Layout (Example)

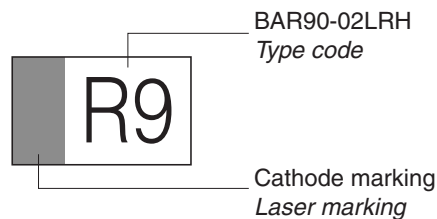

Standard Packing

Reel $\varnothing 180 \text{ mm} = 15.000 \text{ Pieces/Reel}$
 Reel $\varnothing 330 \text{ mm} = 50.000 \text{ Pieces/Reel (optional)}$

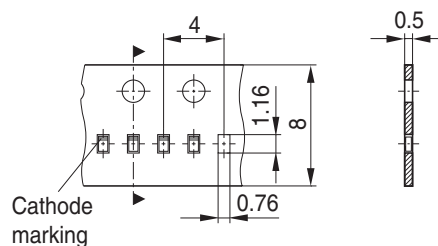

Package Outline

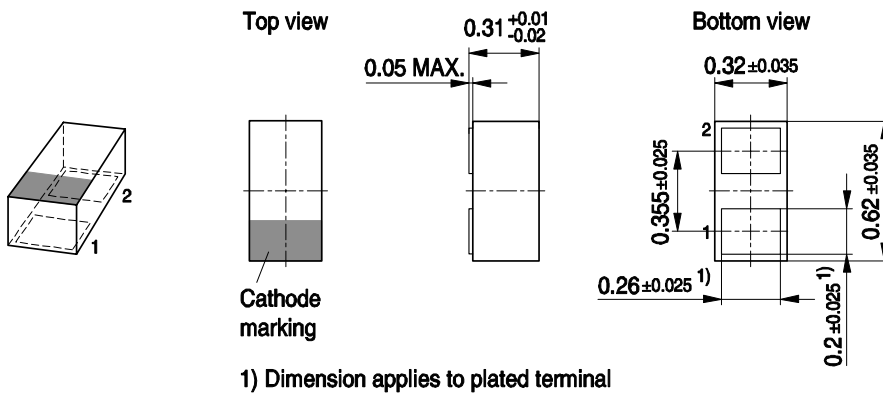

Foot Print

For board assembly information please refer to Infineon website "Packages"

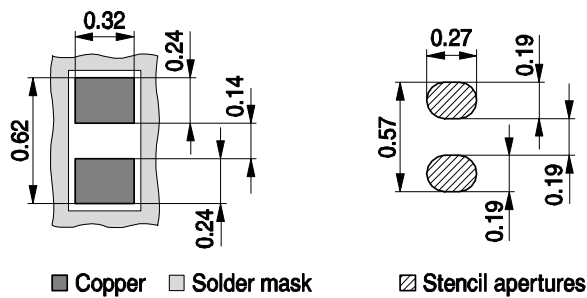

Marking Layout (Example)

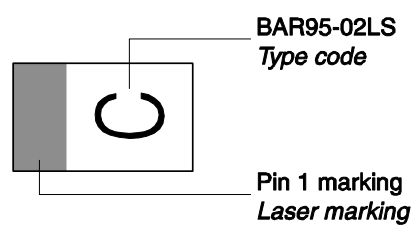

Standard Packing

Reel \varnothing 180 mm = 15.000 Pieces/Reel

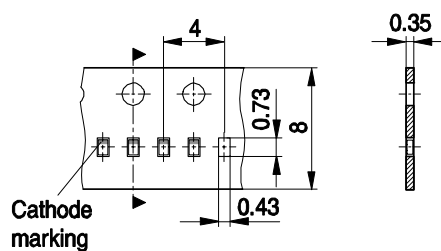

Edition 2009-11-16

**Published by
Infineon Technologies AG
81726 Munich, Germany**

**© 2009 Infineon Technologies AG
All Rights Reserved.**

Legal Disclaimer

The information given in this document shall in no event be regarded as a guarantee of conditions or characteristics. With respect to any examples or hints given herein, any typical values stated herein and/or any information regarding the application of the device, Infineon Technologies hereby disclaims any and all warranties and liabilities of any kind, including without limitation, warranties of non-infringement of intellectual property rights of any third party.

Information

For further information on technology, delivery terms and conditions and prices, please contact the nearest Infineon Technologies Office (www.infineon.com).

Warnings

Due to technical requirements, components may contain dangerous substances. For information on the types in question, please contact the nearest Infineon Technologies Office.

Infineon Technologies components may be used in life-support devices or systems only with the express written approval of Infineon Technologies, if a failure of such components can reasonably be expected to cause the failure of that life-support device or system or to affect the safety or effectiveness of that device or system. Life support devices or systems are intended to be implanted in the human body or to support and/or maintain and sustain and/or protect human life. If they fail, it is reasonable to assume that the health of the user or other persons may be endangered.