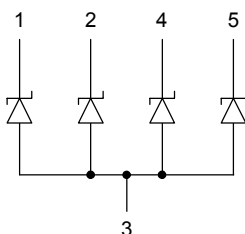

Ultra-Low Capacitance ESD Array

- ESD / transient protection of high-speed data lines exceeding
IEC61000-4-2 (ESD): 20 kV (air / contact)
IEC61000-4-4 (EFT): 2.5 kV / 50 A (5/50 ns)
IEC61000-4-5 (surge): 3 A (8/20 μ s)
- Max. working voltage: 5.3 V
- Very low reverse current: < 1 nA typ.
- Extremely low cap. : 0.4 pF typ. (I/O to GND)
- Very low clamping voltage: 12 V typ.
- Extremely low forward clamping voltage: 4 V typ.
- TSLP-9 package with pad pitch = 0.5 mm
- Optimized pad design to simplify PCB layout
- Pb-free (RoHS compliant) package

Applications

- DVI, HDMI, S-ATA, DisplayPort
- USB 2.0, 10/100/1000 Ethernet, Firewire
- Mobile communication
- Consumer products (STB, MP3; DVD, DSC...)
- LCD displays, camera
- Notebooks and desktop computers, peripherals

ESD5V3U4U-HDMI

Type	Package	Configuration	Marking
ESD5V3U4U-HDMI	TSLP-9-1	4 lines, uni-directional	Z1

Maximum Ratings at $T_A = 25^\circ\text{C}$, unless otherwise specified

Parameter	Symbol	Value	Unit
ESD contact discharge ¹⁾	V_{ESD}	20	kV
Peak pulse current ($t_p = 8 / 20 \mu\text{s}$) ²⁾	I_{pp}	3	A
Operating temperature range	T_{op}	-40...125	°C
Storage temperature	T_{stg}	-65...150	

Electrical Characteristics at $T_A = 25^\circ\text{C}$, unless otherwise specified

Parameter	Symbol	Values			Unit
		min.	typ.	max.	

Characteristics -

Reverse working voltage	V_{RWM}	-	-	5.3	V
Breakdown voltage $I_{\text{(BR)}} = 1 \text{ mA}$, (I/O to GND)	$V_{\text{(BR)}}$	6	-	-	
Reverse current $V_{\text{R}} = 5.3 \text{ V}$, (I/O to GND)	I_{R}	-	< 1	50	nA
Clamping voltage $I_{\text{PP}} = 1 \text{ A}$, $t_p = 8/20 \mu\text{s}^2$, (I/O to GND) $I_{\text{PP}} = 3 \text{ A}$, $t_p = 8/20 \mu\text{s}^2$, (I/O to GND)	V_{CL}	-	10	13	V
		-	12	15	
Forward clamping voltage $I_{\text{PP}} = 1 \text{ A}$, $t_p = 8/20 \mu\text{s}^2$, (GND to I/O) $I_{\text{PP}} = 3 \text{ A}$, $t_p = 8/20 \mu\text{s}^2$, (GND to I/O)	V_{FC}	-	2	4	
		-	4	6	
Diode capacitance $V_{\text{R}} = 0 \text{ V}$, $f = 1 \text{ MHz}$, (I/O GND) ³⁾ $V_{\text{R}} = 0 \text{ V}$, $f = 1 \text{ MHz}$, (I/O to I/O) ⁴⁾	C_{T}	-	0.4	0.6	pF
		-	0.2	0.3	

¹⁾ V_{ESD} according to IEC61000-4-2

²⁾ I_{pp} according to IEC61000-4-5

³⁾ Total capacitance line to ground

⁴⁾ Line to line capacitance

Clamping voltage, $V_{cl} = f(I_{pp})$

$t_p = 8 / 20 \mu s$, (I/O to GND)

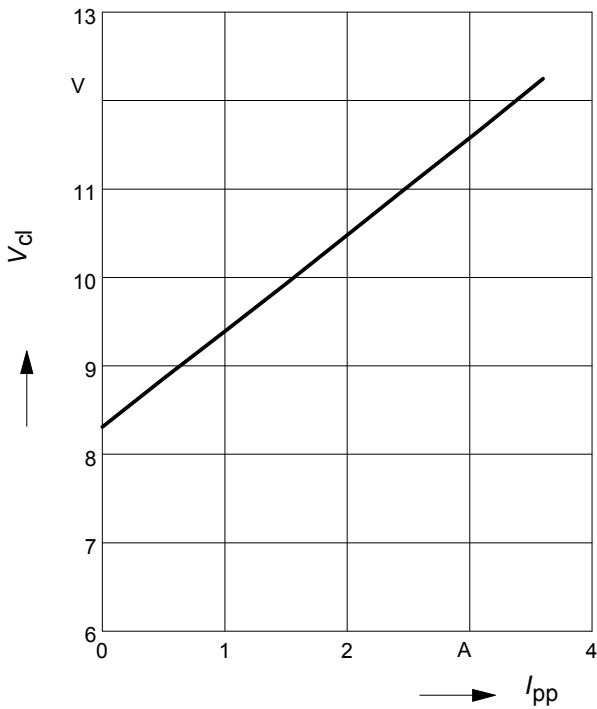

Forward clamping voltage $V_{FC} = f(I_{PP})$

$t_p = 8 / 20 \mu s$, (GND to I/O)

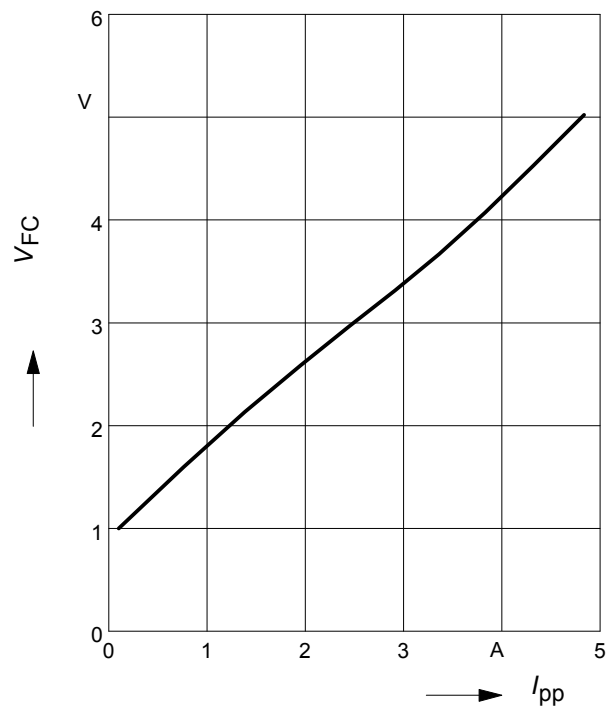

Reverse current $I_R = f(T_A)$

$V_R = 5.3 V$, (I/O to GND)

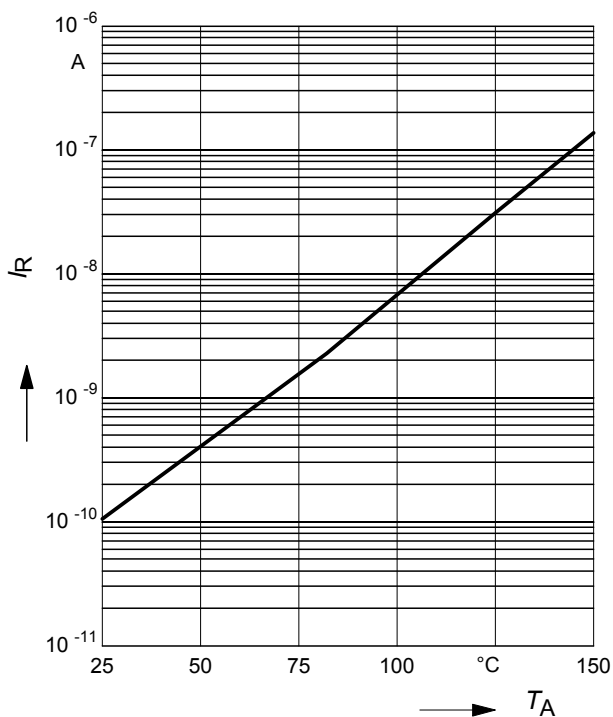

Diode capacitance $C_T = f(V_R)$

$f = 1 MHz$, (I/O to GND))

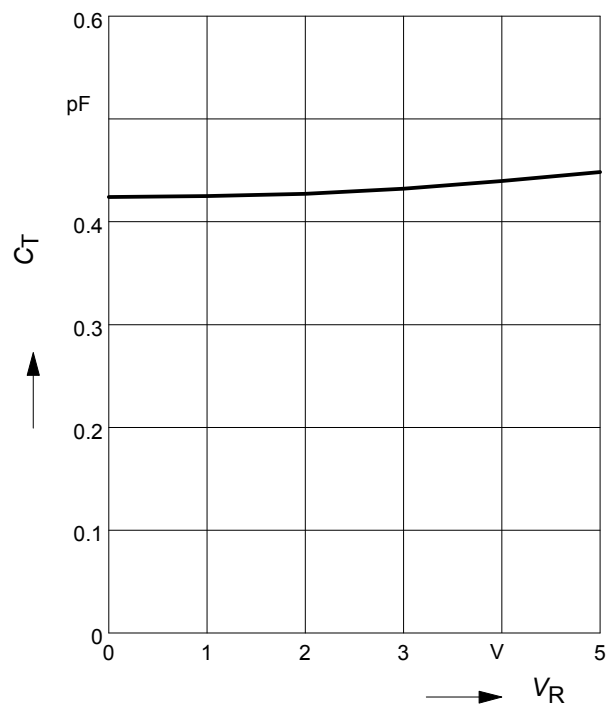

Line capacitance $C_T = f(f)$

$V_R =$ parameter, (I/O to GND)

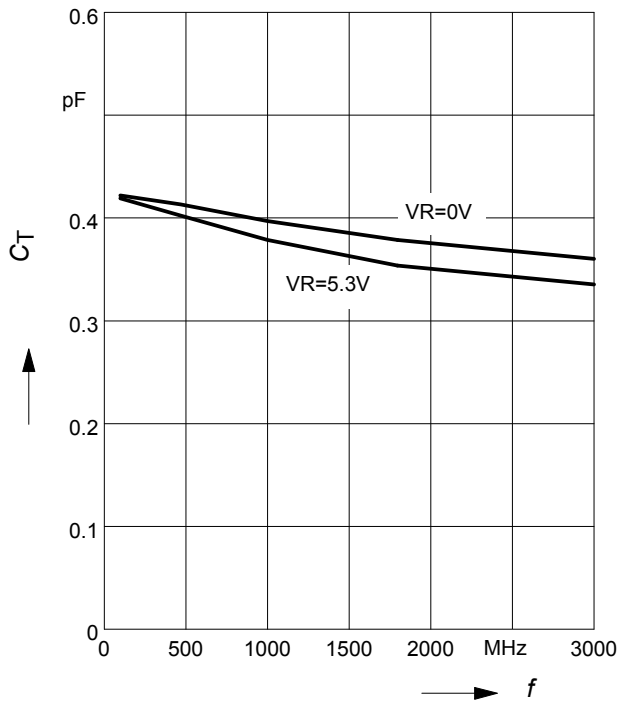

Line capacitance $C_T = f(T_A)$

$V_R = 0 V, f = 1 MHz$

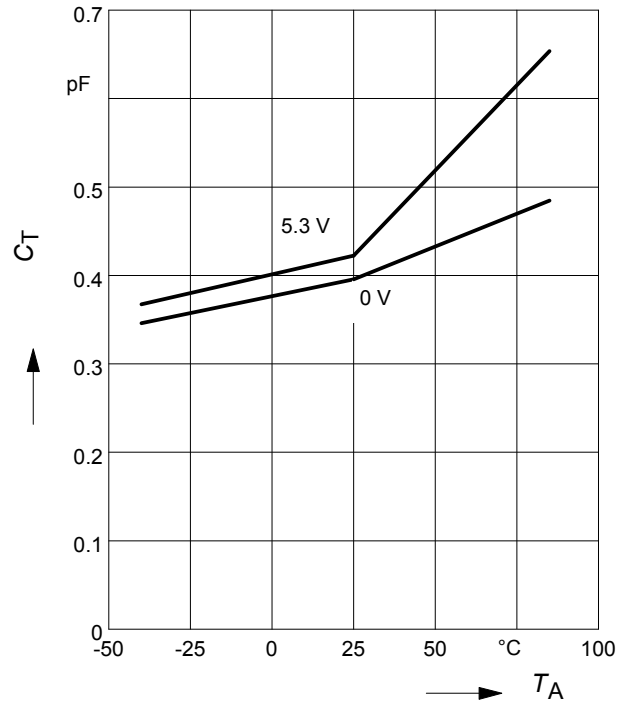

4 lines, unidirectional ESD5V3U4U-HDMI

For protection on the 5 V supply rail please refer to ESD5V3U1U- TVS diode data sheet.

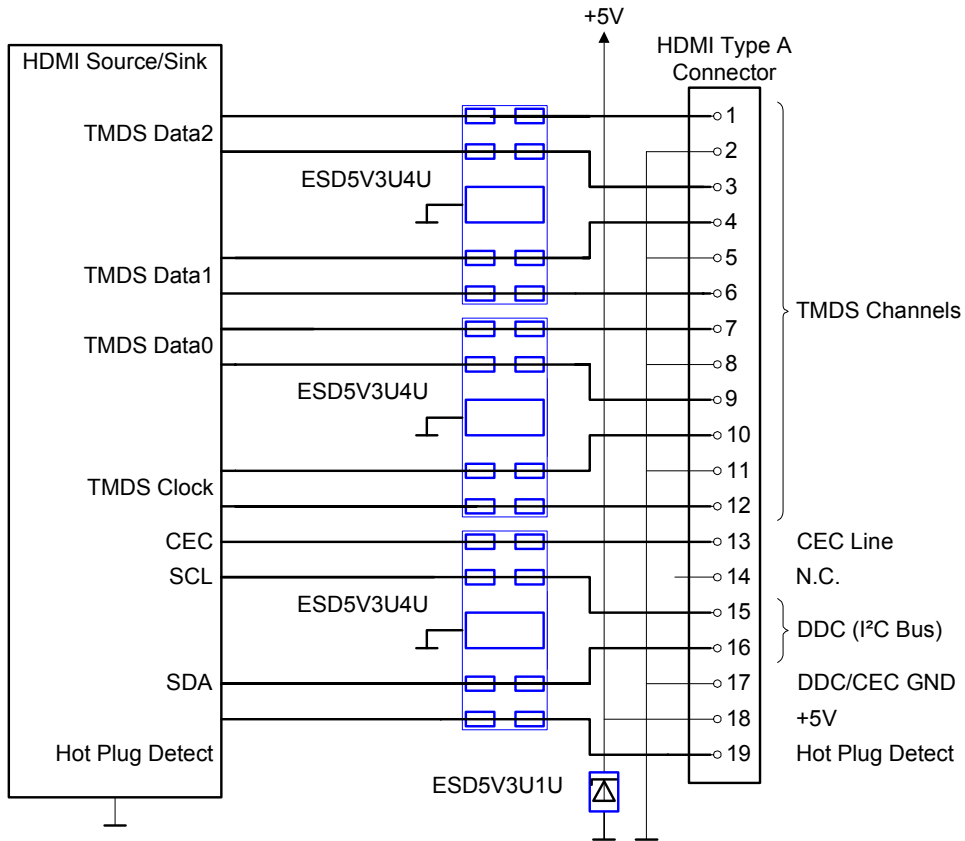

Edition 2006-02-01

Published by

Infineon Technologies AG

81726 München, Germany

© Infineon Technologies AG 2007.

All Rights Reserved.

Attention please!

The information given in this dokument shall in no event be regarded as a guarantee of conditions or characteristics ("Beschaffheitsgarantie"). With respect to any examples or hints given herein, any typical values stated herein and/or any information regarding the application of the device, Infineon Technologies hereby disclaims any and all warranties and liabilities of any kind, including without limitation warranties of non-infringement of intellectual property rights of any third party.

Information

For further information on technology, delivery terms and conditions and prices please contact your nearest Infineon Technologies Office (www.infineon.com).

Warnings

Due to technical requirements components may contain dangerous substances. For information on the types in question please contact your nearest Infineon Technologies Office.

Infineon Technologies Components may only be used in life-support devices or systems with the express written approval of Infineon Technologies, if a failure of such components can reasonably be expected to cause the failure of that life-support device or system, or to affect the safety or effectiveness of that device or system.

Life support devices or systems are intended to be implanted in the human body, or to support and/or maintain and sustain and/or protect human life. If they fail, it is reasonable to assume that the health of the user or other persons may be endangered.