

# ET Series Sealed Subminiature Toggle Switches

## Features/Benefits

- Sealed against solder and cleaning process contaminants
- ESD protection available
- Thru-hole and surface mount models
- Compact size and small footprint save PCB space
- RoHS compliant models available



## Typical Applications

- Hand-held telecommunications
- Instrumentation
- Medical equipment

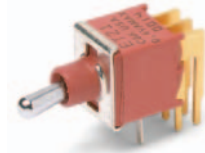

## Specifications

**CONTACT RATING:** B contact material: 0.4 VA max. @ 20 V AC or DC max. See page F-35 for additional ratings.

**ELECTRICAL LIFE:** ETX1 models: 60,000 make-and-break cycles at full load. All other models: 30,000 cycles.

**CONTACT RESISTANCE:** Below 20 m Ω typ. initial @ 2-4 V DC, 100 mA, for both silver and gold plated contacts.

**INSULATION RESISTANCE:** 10<sup>9</sup> Ω min.

**ELECTROSTATIC DISCHARGE (ESD) RESISTANT OPTION:**  
M3 & S3 insulating actuator only: 9,000 V DC min. @ sea level, actuator to terminals. F1 conductive bushing only: Dissipates up to 20,000 V DC from actuator to ground. M3 & S3 actuator and F1 bushing options are not recommended for use together.

**DIELECTRIC STRENGTH:** 1000 Vrms min. @ sea level.

**OPERATING TEMPERATURE:** -30°C to 85°C.

**SOLDERABILITY:** Per MIL-STD-202F method 208D, or EIA RS-186E method 9 (1 hour steam aging).

**DEGREE OF PROTECTION:** IP57; Protection against harmful dust deposit, full-scale voltage protection, temporary immersion.

**PACKAGING:** Surface mount switches are shipped in tape and reel packaging, see page F-31 for drawings and reel information.

## Materials

**CASE & BUSHING:** Glass filled nylon 6/6, flame retardant, heat stabilized (UL 94V-0) or glass filled 4/6 nylon, flame retardant, heat stabilized (UL 94V-0). F1 conductive bushing option is impregnated with carbon fibers.

**ACTUATOR:** M3 & S3 anti-static actuator: Nylon 4/6, black standard (UL 94V-0). All other actuators: Brass, chrome plated. Internal o-ring seal standard with all actuators.

**SWITCH SUPPORT:** Brass, tin plated.

**CONTACTS & TERMINALS:** B contact material: Copper alloy, with gold plate over nickel plate. Q contact material: Copper alloy, silver plated. See F-35 for additional contact materials.

**TERMINAL SEAL:** Epoxy.

**NOTE:** Any models supplied with Q, B, G, P or R contact material are RoHS compliant and compatible.

**NOTE:** Specifications and materials listed above are for switches with standard options. For information on specific and custom switches, consult Customer Service Center.

## Build-A-Switch

To order, simply select desired option from each category and place in the appropriate box. Available options are shown and described on pages F-26 thru F-31. For additional options not shown in catalog, consult our Customer Service Center. All models are process sealed to withstand machine soldering temperatures and pressure wash cleaning methods.

<p><b>Switch Function</b></p> <p><b>ET01</b> SP, On-None-On  <b>ET02</b> SPST, Off-None-On  <b>ET03</b> SP, On-Off-On  <b>ET05</b> SP, Mom.-Off-Mom.  <b>ET07</b> SP, On-Off-Mom.  <b>ET08</b> SP, On-None-Mom.  <b>ET21</b> DP, On-None-On  <b>ET23</b> DP, On-Off-On  <b>ET24</b> DP, On-On-On  <b>ET25</b> DP, Mom.-Off-Mom.  <b>ET27</b> DP, On-Off-Mom.  <b>ET28</b> DP, On-None-Mom.</p>	<p><b>Actuator</b></p> <p><b>M</b> .240" high  <b>M3</b> Plastic, anti-static, .240" high  <b>S</b> .400" high  <b>L</b> .320" high  <b>S1</b> .540" high</p>	<p><b>Bushing</b></p> <p><b>D1</b> .177" High, Unthreaded  <b>F1</b> .177" high, unthreaded, ESD conductive</p>	<p><b>Terminations</b></p> <p><b>A</b> Right angle, PC thru-hole  <b>AV</b> Vertical right angle, PC thru-hole  <b>C</b> PC Thru-hole  <b>SA</b> Right angle, surface mount  <b>SA1</b> Right angle, surface mount rear-facing  <b>V3</b> Vertical mount, V-bracket  <b>AV3</b> Vertical right angle, snap-in, PC thru-hole  <b>V31</b> Vertical mount, V-bracket, snap-in  <b>W</b> Wire wrap</p>	<p><b>Contact Material</b></p> <p><b>B</b> Gold  <b>P</b> Gold, matte tin  <b>Q</b> Silver  <b>S</b> Silver/matte-tin  <b>G</b> Gold over silver  <b>R</b> Gold over silver, matte-tin</p>	<p><b>Seal</b></p> <p><b>E</b> Epoxy</p>	<p><b>Plastic Actuator Color</b></p> <p><b>NONE</b> No actuator color  <b>2</b> Black  <b>1</b> White</p>
--	---	---	--	--	--	---



Toggle



Dimensions are shown: Inches (mm)  
Specifications and dimensions subject to change

# ET Series Sealed Subminiature Toggle Switches

## SWITCH FUNCTION

NO. POLES	MODEL NO.	SWITCH FUNCTION			CONNECTED TERMINALS			SCHEMATIC
		POS. 1	POS. 2	POS. 3	POS. 1	POS. 2	POS. 3	
SP	<b>ET01</b>	ON	NONE	ON	2-3	N/A	2-1	
	<b>ET03</b>	ON	OFF	ON	2-3	OPEN	2-1	
	<b>ET05</b>	MOM.	OFF	MOM.				
	<b>ET07</b>	ON	OFF	MOM.				
	<b>ET08</b>	ON	NONE	MOM.	2-3	N/A	2-1	
	<b>ET02</b>	OFF	NONE	ON	OPEN	N/A	3-1	
<p><b>SPDT</b></p> <p>Part number shown: ET01MD1CBE      ET02 Models: Omit terminal 2</p>								
DP	<b>ET21</b>	ON	NONE	ON	2-3,5-6	N/A	2-1,5-4	
	<b>ET23</b>	ON	OFF	ON	2-3,5-6	OPEN	2-1,5-4	
	<b>ET25</b>	MOM.	OFF	MOM.				
	<b>ET27</b>	ON	OFF	MOM.				
	<b>ET28</b>	ON	NONE	MOM.	2-3,5-6	N/A	2-1,5-4	
	<b>ET24**</b>	ON	ON	ON	2-3,5-6	2-3,5-4	2-1,5-4	DPDT
<p><b>DPDT</b></p> <p>Part number shown: ET21MD1CBE</p>								

MOM. = Momentary

\*\* Wiring for 3-way switch, see Section N.

All models with all options (except M3 actuator) when ordered with G, L, R or Q contact material except with F1 conductive bushing.



F

Toggle

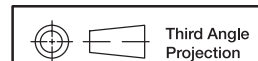

Dimensions are shown: Inches (mm)  
Specifications and dimensions subject to change

# ET Series Sealed Subminiature Toggle Switches

## ACTUATOR

**M** .240" HIGH

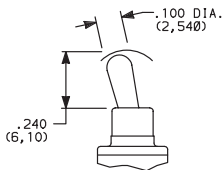

Standard with A, AV, V3 & V31 terminations.

**M3** PLASTIC, ANTISTATIC, .240" HIGH

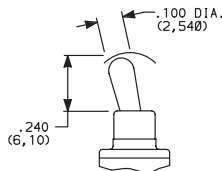

Material: Nylon 4/6 (UL 94V-0), black standard. Static resistance: 9,000 V DC min. @ sea level, actuator to terminals. Not available with F1 conductive bushing option. Not UL approved.

**S** .400" HIGH

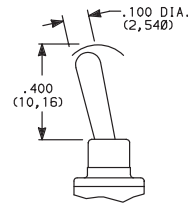

Standard with C or W terminations.

**L** .320" HIGH

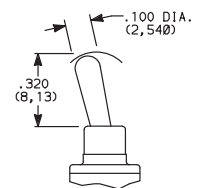

**S1** .540" HIGH

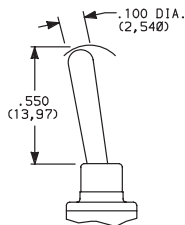

OPTION CODE	PLASTIC ACTUATOR COLOR
(NONE)	BLACK (M3 & S3 only)
1	WHITE (M3 & S3 only)

**NOTE:** All actuators have chrome finish (except M3 & S3).

## BUSHING

**D1** .177" HIGH, UNTHREADED

**F1** ESD, CONDUCTIVE BUSHING UNTHREADED, .177" HIGH

F1 bushing is not UL/CSA approved

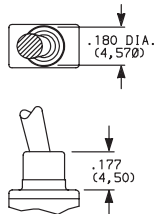

**NOTE:** ESD protection depends on proper grounding of switch support bracket. F1 conductive bushing option is impregnated with carbon fibers; dissipates electrostatic discharge (ESD) up to 20,000 V from actuator to ground.

Available with all metal actuator options and A, AV, AV3, V3 and V31 termination options only.

Internal actuator o-ring seal standard.

## TERMINATIONS

**C** PC THRU-HOLE

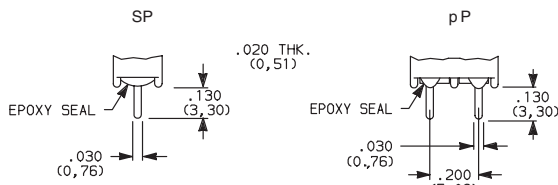

PC MOUNTING

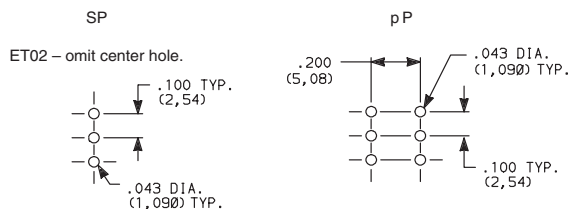

SP and DP

Not available with F1 conductive bushing.

**W** WIRE WRAP

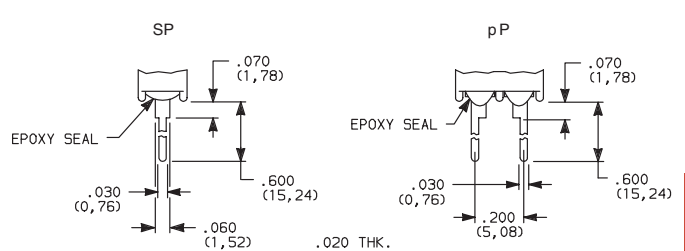

SP and DP

Not available with F1 conductive bushing.



Dimensions are shown: Inches (mm)  
Specifications and dimensions subject to change



F

Toggle

# ET Series Sealed Subminiature Toggle Switches

## TERMINATIONS

**A** RIGHT ANGLE, PC THRU-HOLE

**ET01MD1ABE**  
Horizontal Actuation  
**SPDT**

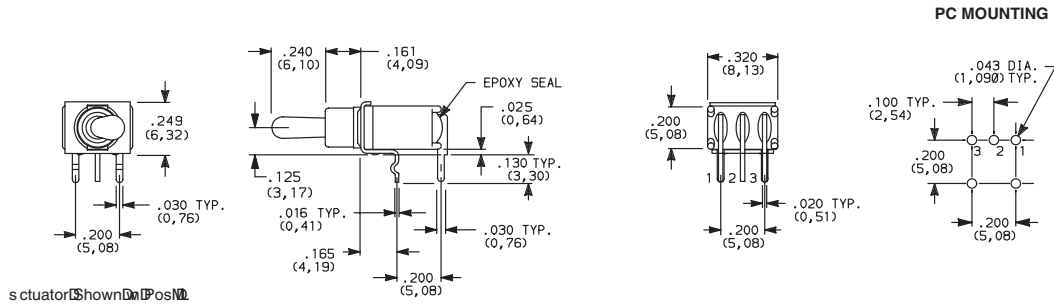

Not available with ET02 model.

**A** RIGHT ANGLE, PC THRU-HOLE

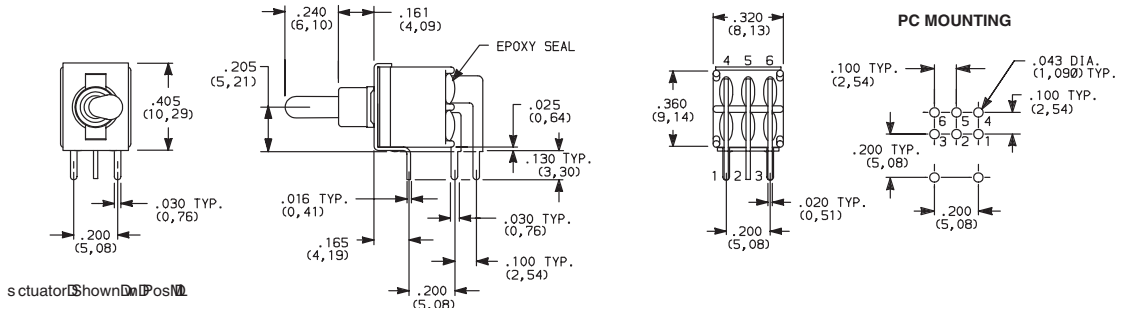

**AV** VERTICAL RIGHT ANGLE, PC THRU-HOLE

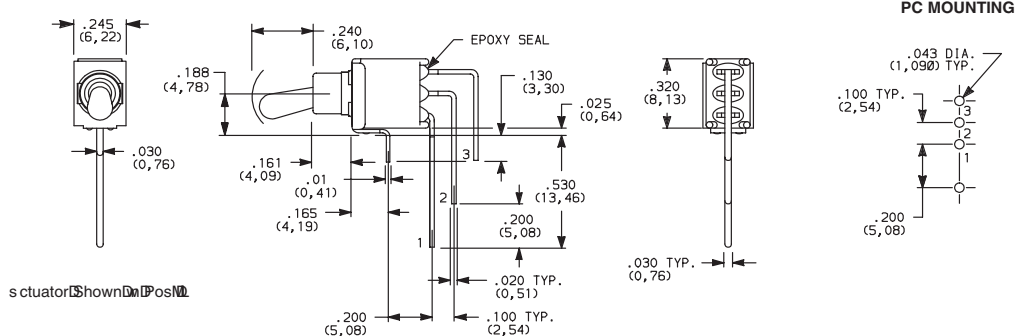
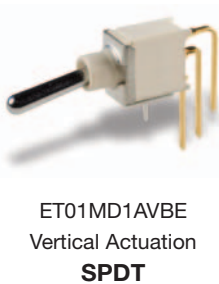

ET02 - omit terminal 2.

**NOTE:** Terminal bend radii and lead-in manufacturing option.

**AV** VERTICAL RIGHT ANGLE, PC THRU-HOLE

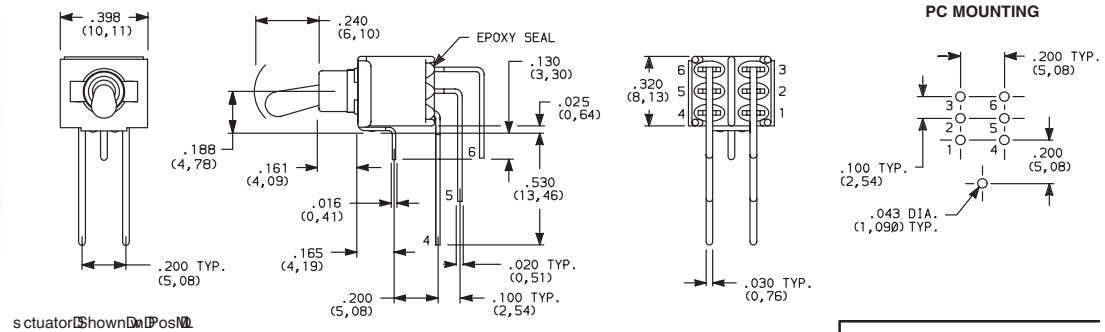

**NOTE:** Terminal bend radii and lead-in manufacturing option.



Dimensions are shown: Inches (mm)  
Specifications and dimensions subject to change

www.ck-components.com

# ET Series Sealed Subminiature Toggle Switches

## TERMINATIONS

### AV3 VERTICAL RIGHT ANGLE, SNAP-IN, PC THRU-HOLE

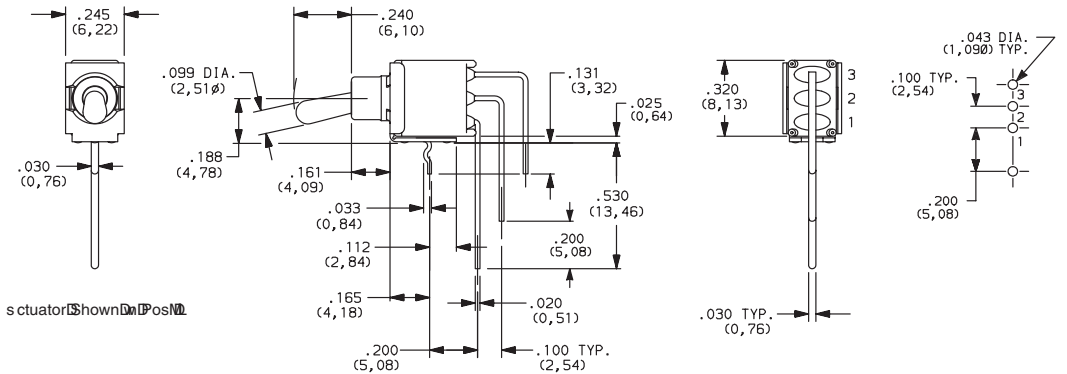

### SA RIGHT ANGLE, SURFACE MOUNT

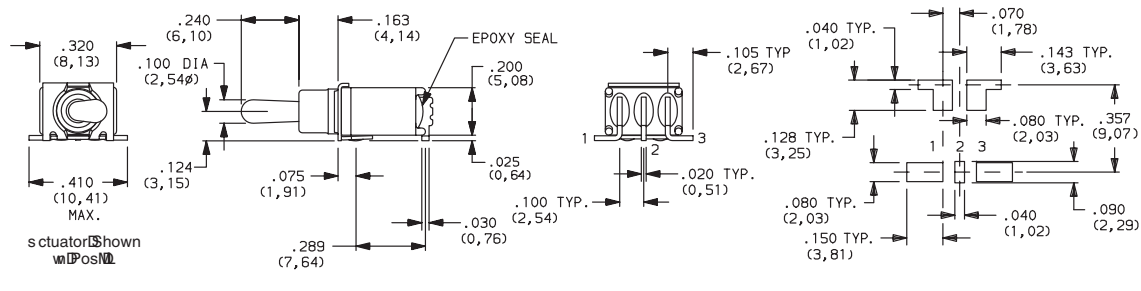

Not available with S and S1 actuators. Standard with tape & reel packaging. See page F-31.

### SA1 RIGHT ANGLE, SURFACE MOUNT

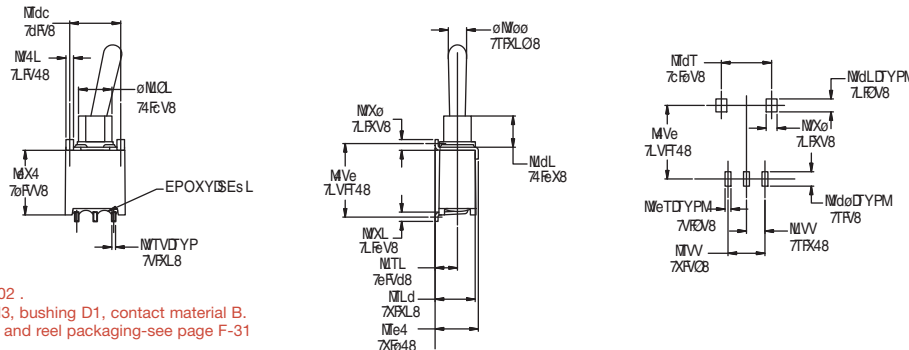

Not available in ET02.  
Actuators M and M3, bushing D1, contact material B.  
Standard with tape and reel packaging-see page F-31

### V3 VERTICAL MOUNT, V-BRACKET

### V31 VERTICAL MOUNT, V-BRACKET, SNAP-IN

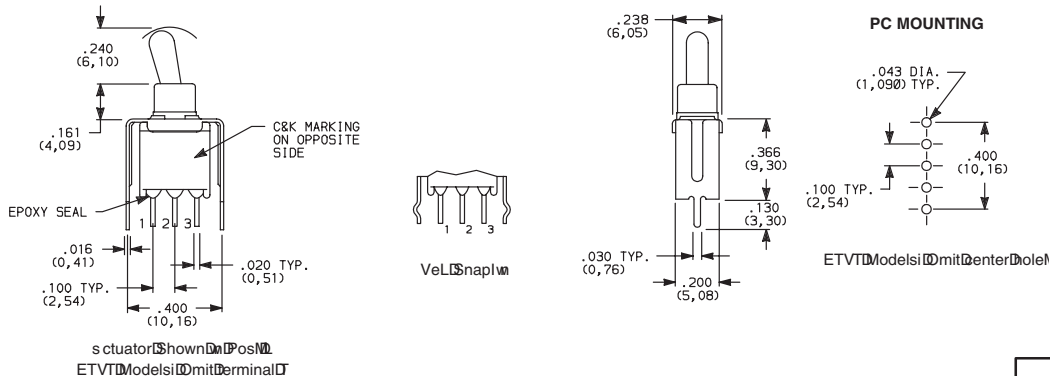

Dimensions are shown: Inches (mm)  
Specifications and dimensions subject to change



F

Toggle

# ET Series Sealed Subminiature Toggle Switches

## TERMINATIONS

### V3 VERTICAL MOUNT, V-BRACKET

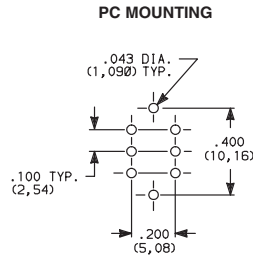
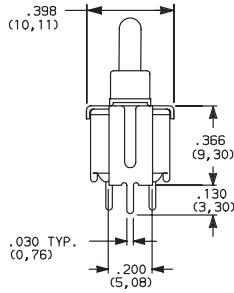
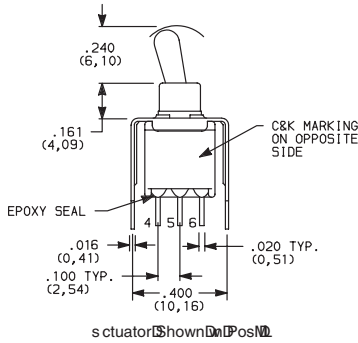

ET21MD1V3BE  
DPDT

## CONTACT MATERIAL

OPTION CODE	CONTACT MATERIAL	TERMINAL PLATING	RATINGS	
B	GOLD <sup>1</sup>	GOLD <sup>1</sup>	LOW LEVEL/DRY CIRCUIT	0.4 VA MAX. @ 20 V AC OR DC MAX.
P		MATTE-TIN <sup>6</sup>		
Q	SILVER <sup>4,5</sup>	SILVER <sup>5</sup>	POWER	ETX1 MODELS: 3 AMPS @ 120 V AC OR 28 V DC ALL OTHER MODELS: 2 AMPS @ 120 V AC OR 28 V DC
S		MATTE-TIN <sup>6</sup>		
G	GOLD OVER SILVER <sup>2,3</sup>	GOLD <sup>3</sup>	LOW LEVEL/DRY CIRCUIT OR POWER	ETX1 MODELS: 0.4 VA MAX. @ 20 V AC OR DC MAX. OR 3 AMPS @ 120 V AC OR 28 V DC ALL OTHER MODELS: 0.4 VA MAX. @ 20 V AC OR DC MAX. OR 2 AMPS @ 120 V AC OR 28 V DC
R		MATTE-TIN <sup>6</sup>		

\* Note: See Technical Data section of this catalog for RoHS compliant and compatible definitions and specifications.

<sup>1</sup> CONTACTS & TERMINALS: Copper alloy, with gold plate over nickel plate.

<sup>2</sup> END CONTACTS: Coin silver, with gold plate over nickel plate.

<sup>3</sup> CENTER CONTACTS & ALL TERMINALS: Copper alloy, with gold plate over nickel plate.

<sup>4</sup> END CONTACTS: Coin silver, silver plated.

<sup>5</sup> CENTER CONTACT & ALL TERMINALS: Copper alloy, silver plated.

<sup>6</sup> TERMINALS: Copper alloy, with matte tin over nickel plate.

**NOTE:** Any models supplied with Q, B, G, P or R contact material are RoHS compliant.

All models with all options (except M3 actuator) when ordered with G, L, R or Q contact material except with F1 conductive bushing.

## SEAL

### E EPOXY SEAL

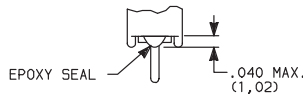

## AVAILABLE HARDWARE

### Cap

**PART NO.**  
706201000 WHITE  
706202000 BLACK  
706203000 RED

Material: Vinyl  
Finish: Matte



**NOTE:** Other colors available, consult Customer Service Center.



Dimensions are shown: Inches (mm)  
Specifications and dimensions subject to change

www.ck-components.com

# ET Series Sealed Subminiature Toggle Switches

## TAPE & REEL

For part number ET01M3D1SAKE

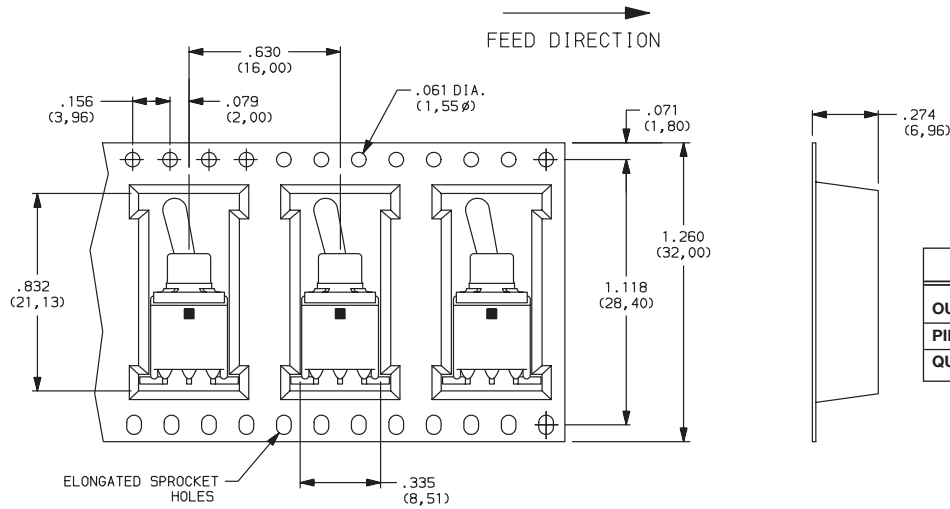

REEL INFORMATION	
OUTSIDE DIAMETER	13.00 (330,0)
PILOT HOLE	.512 (13,0)
QUANTITY PER REEL	600

For part number ET01M3D1SA1BE

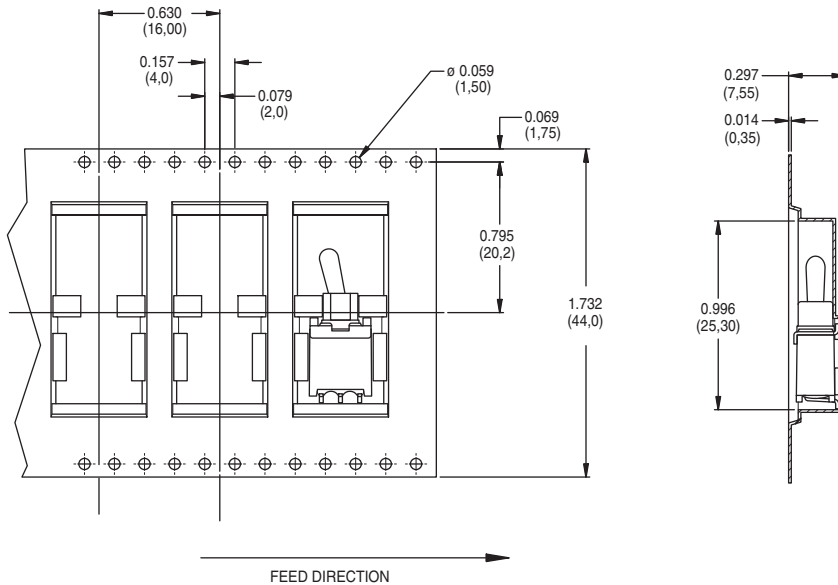

REEL INFORMATION	
OUTSIDE DIAMETER	13.00 (330,0)
PILOT HOLE	.795 (20,20)
QUANTITY PER REEL	500

