

Customer Name	<b>Standard</b>	FUJITSU MEDIA DEVICES LIMITED	
System	EGSM-Rx (50/150)	DATE	Apr. 01, 2005
FMD Part Number	FAR-F5KB-942M50-B4EB	Version 4.0 d	
Customer No.		Reference No.	

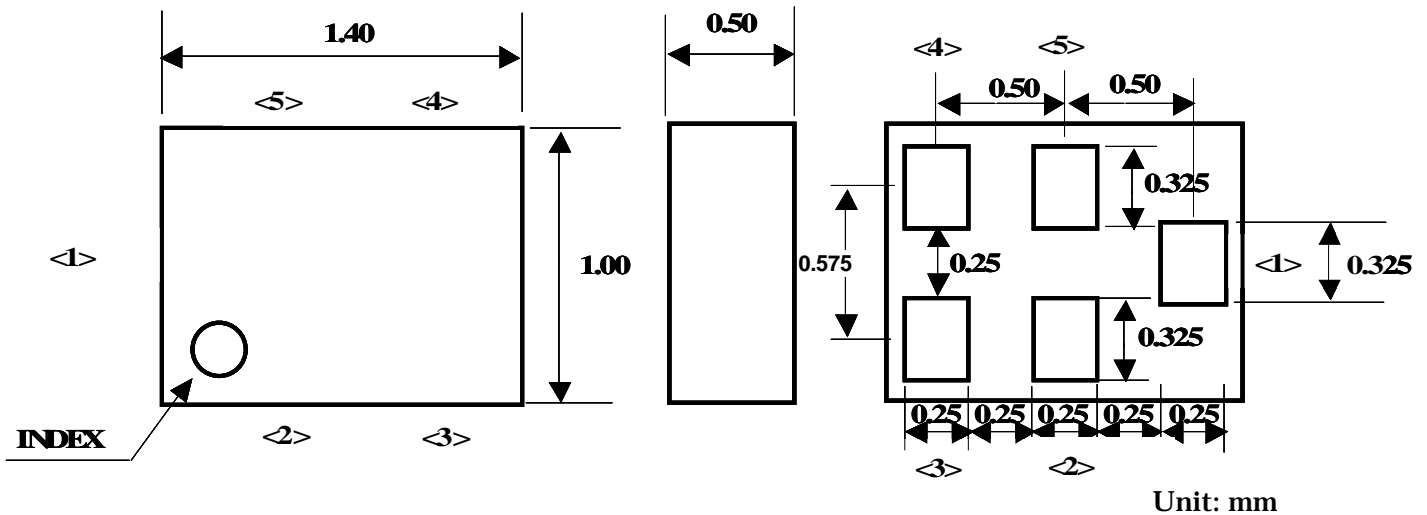
**Table 1 Electrical Specification**

Passband : 925 ~ 960 MHz						
Item	Condition (MHz)	Specification			Unit	Remark
		Min.	Typ.	Max.		
Insertion Loss	925 ~ 960	-	1.6	2.5	dB	
Ripple	925 ~ 960	-	0.4	1.6	dB	
Absolute attenuation	DC ~ 880	40	66	-	dB	
	880 ~ 905	30	38	-	dB	
	905 ~ 915	18	26	-	dB	
	980 ~ 1025	25	33	-	dB	
	1025 ~ 2880	36	50	-	dB	
	2880 ~ 6000	30	50	-	dB	
VSWR(Input)	925 ~ 960	-	1.7	2.0	-	
VSWR(Output)	925 ~ 960	-	1.6	2.0	-	
Amplitude Balance ( S <sub>21</sub> /S <sub>31</sub>  )	925 ~ 960	-1.0	0/ +0.5	+1.0	dB	
Phase Balance (∠S <sub>21</sub> -∠S <sub>31</sub> +180)	925 ~ 960	-10	0/+4	+10	deg	
Input Impedance	Unbalanced	50			ohm	
Output Impedance	Balanced	150//82nH			ohm	
Input Power	925 ~ 960	-	-	+13	dBm	
Operating temperature		-30 ~ +85			°C	
Device size		1.4typ. x 1.0typ. x 0.50max.			mm	

Customer Name	Standard	FUJITSU MEDIA DEVICES LIMITED	
System	EGSM-Rx (50/150)	DATE	Apr. 01, 2005
FMD Part Number	FAR-F5KB-942M50-B4EB	Version 4.0 d	
Customer No.		Reference No.	

**Dimension**

Device size: 1.4typ. x 1.0typ. x 0.50max.

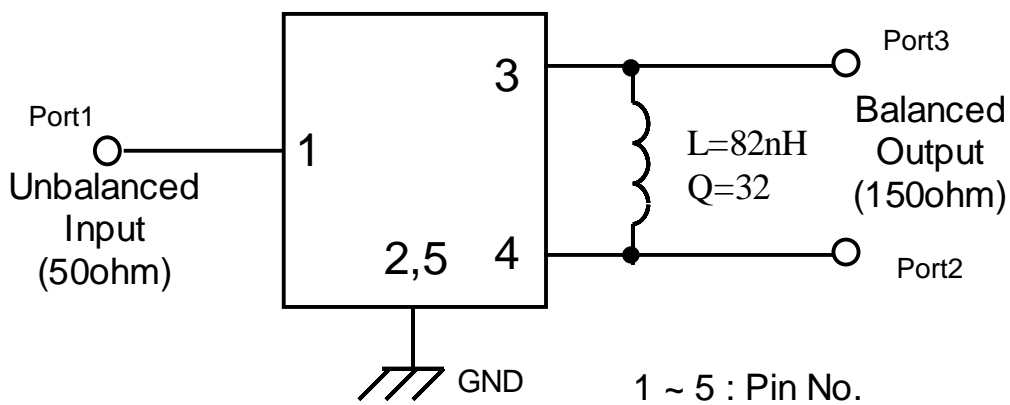


Unit: mm

**Pin Configuration**

Pin No.	Symbol	Function
1	IN	Unbalanced pin
2	GND	Ground
3	OUT	Balanced pin
4	OUT	Balanced pin
5	GND	Ground

**Evaluation Circuit**



Customer Name	<b>Standard</b>	FUJITSU MEDIA DEVICES LIMITED	
System	EGSM-Rx (50/150)	DATE	Apr. 01, 2005
FMD Part Number	FAR-F5KB-942M50-B4EB	Version 4.0 d	
Customer No.		Reference No.	

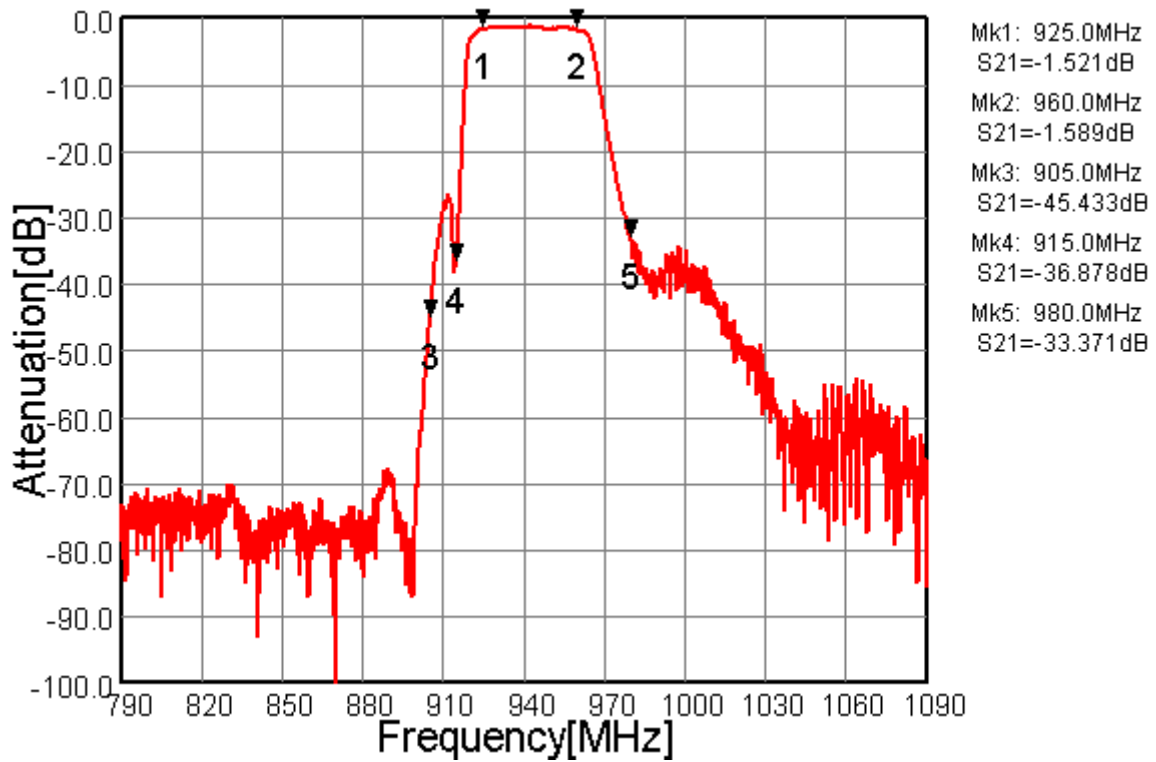


Fig.1 Pass-band Characteristics

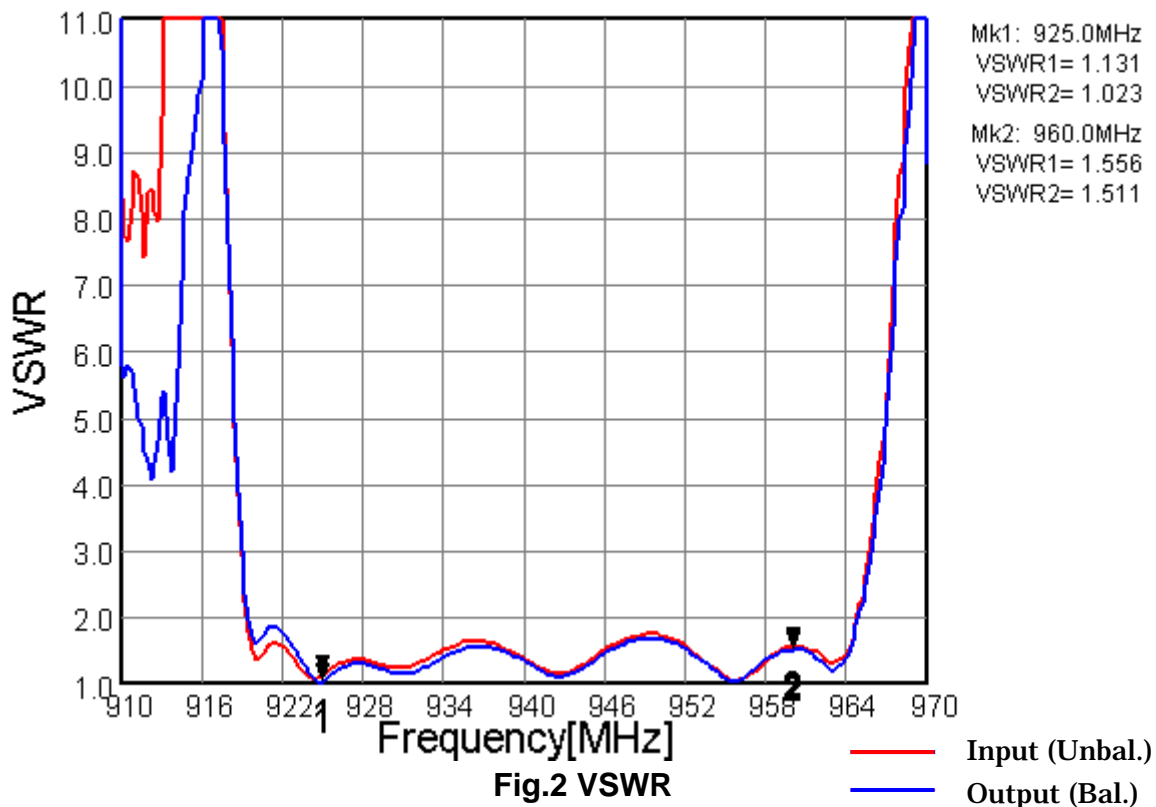
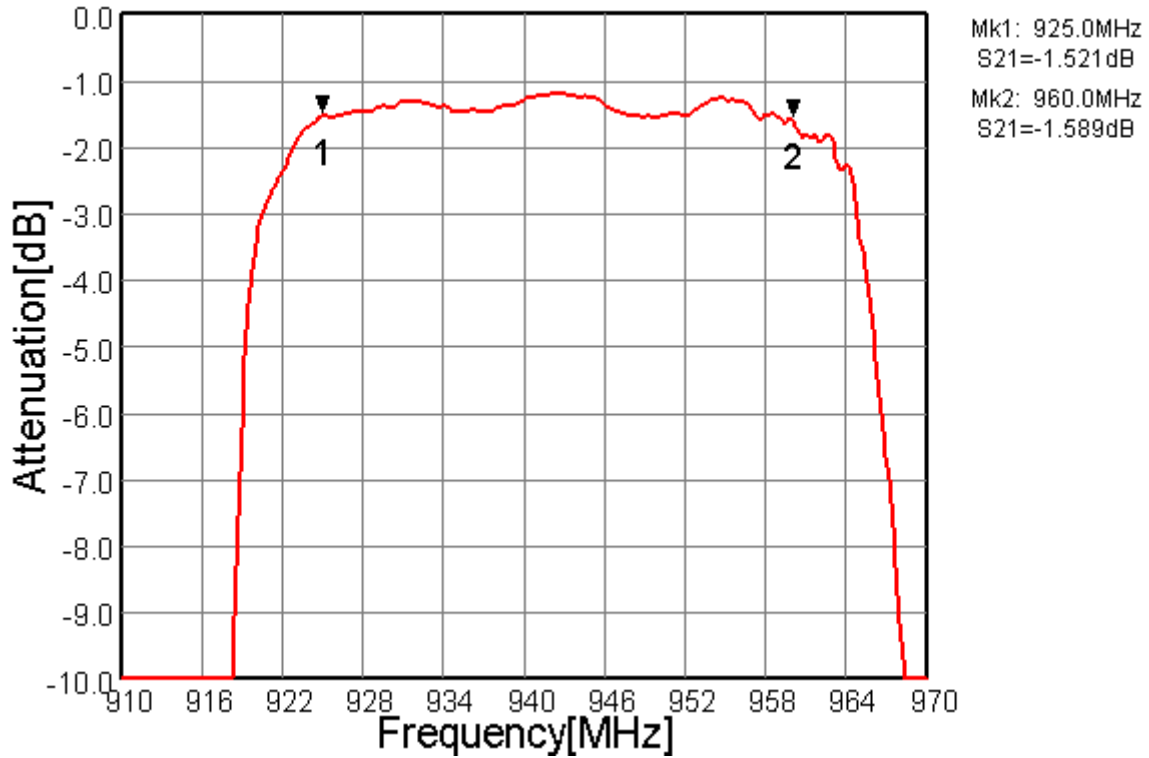


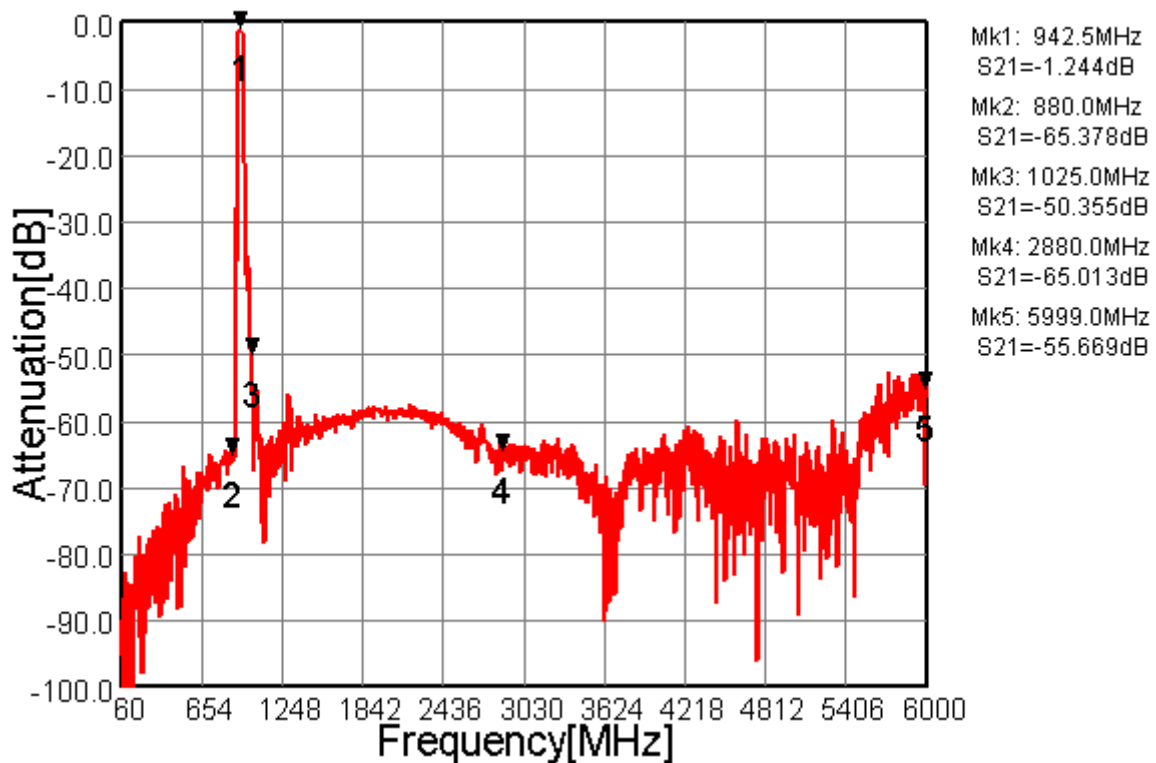
Fig.2 VSWR

— Input (Unbal.)  
 — Output (Bal.)

Customer Name	<b>Standard</b>	FUJITSU MEDIA DEVICES LIMITED	
System	EGSM-Rx (50/150)	DATE	Apr. 01, 2005
FMD Part Number	FAR-F5KB-942M50-B4EB	Version 4.0 d	
Customer No.		Reference No.	

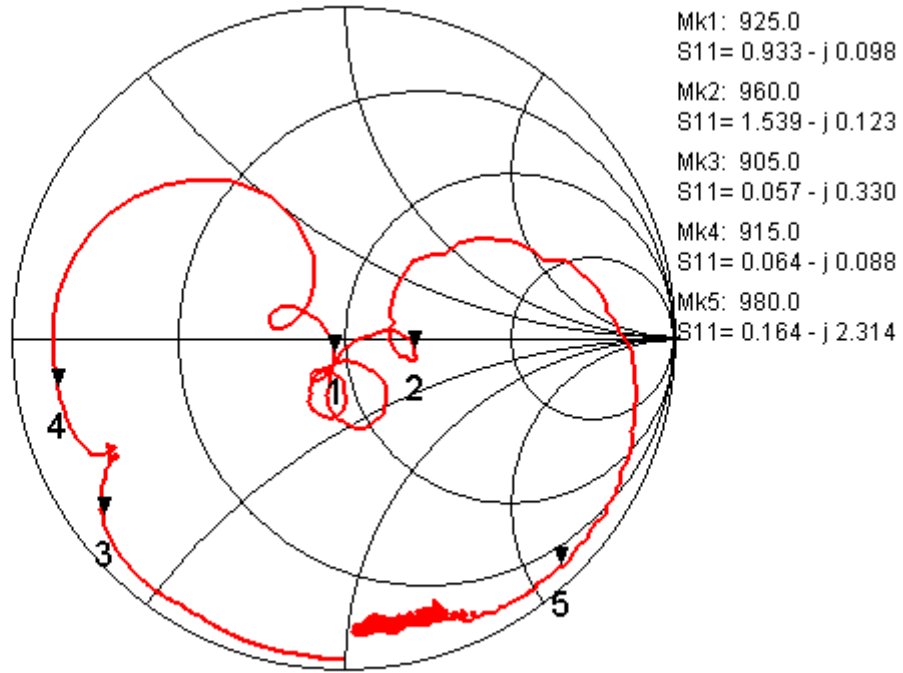


**Fig.3 In-band Characteristics**

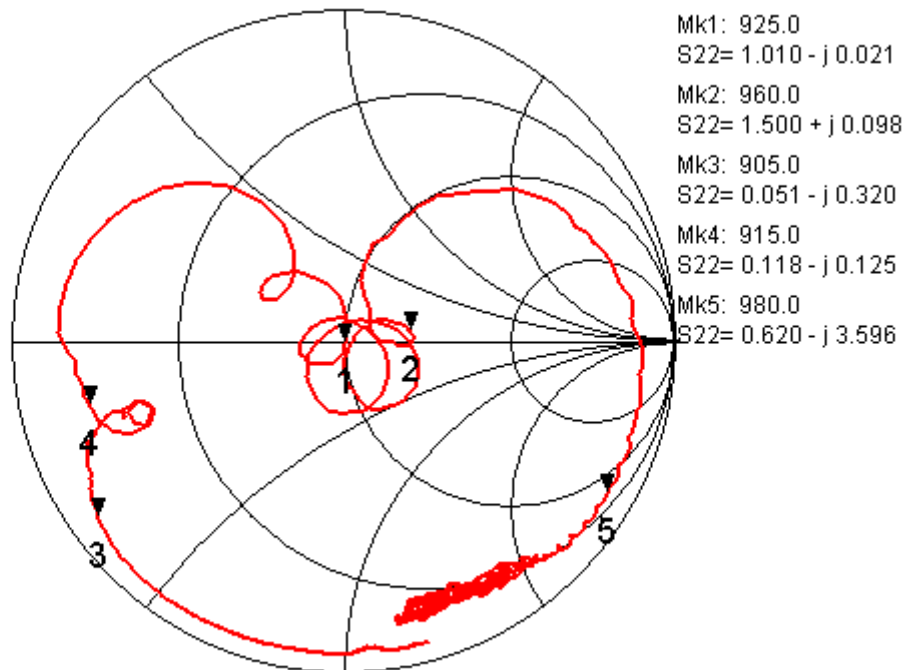


**Fig.4 Wide-band Characteristics**

Customer Name	Standard	FUJITSU MEDIA DEVICES LIMITED	
System	EGSM-Rx (50/150)	DATE	Apr. 01, 2005
FMD Part Number	FAR-F5KB-942M50-B4EB	Version 4.0 d	
Customer No.		Reference No.	



**Fig.5 Input Impedance (Unbalance)**



**Fig.6 Output Impedance (Balance)**

Customer Name	<b>Standard</b>	FUJITSU MEDIA DEVICES LIMITED	
System	EGSM-Rx (50/150)	DATE	Apr. 01, 2005
FMD Part Number	FAR-F5KB-942M50-B4EB	Version 4.0 d	
Customer No.		Reference No.	

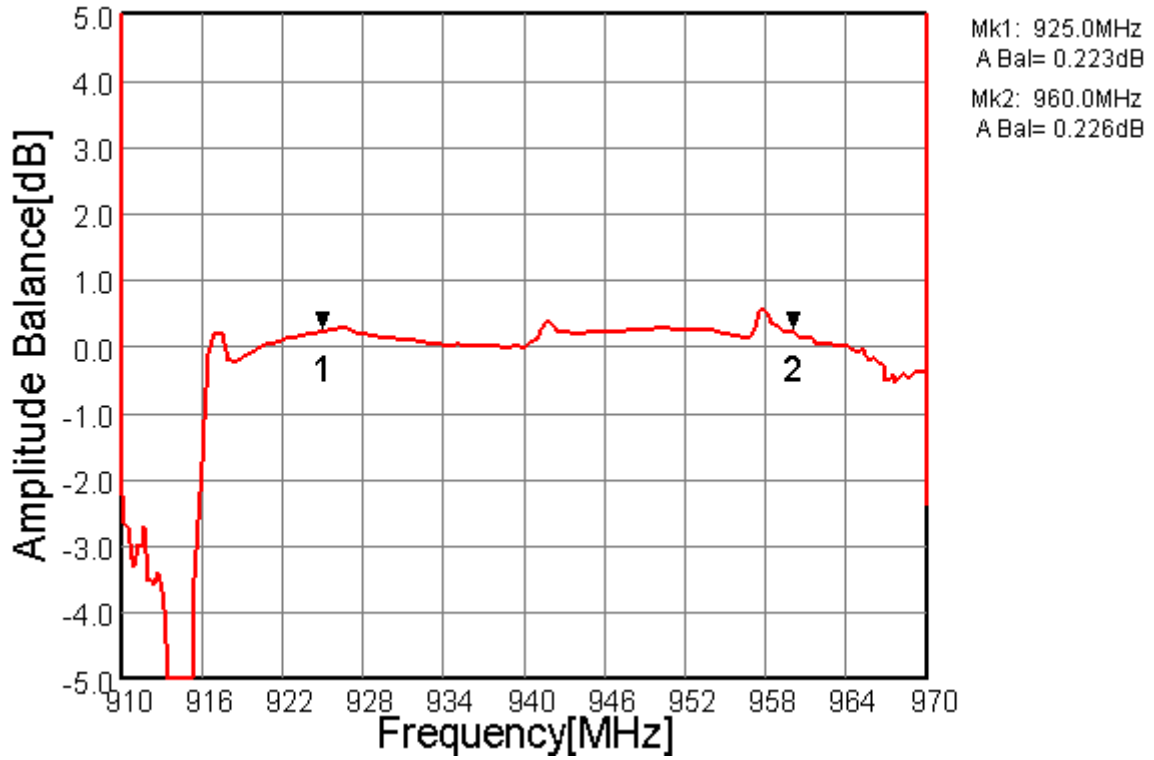


Fig.7 Amplitude Balance

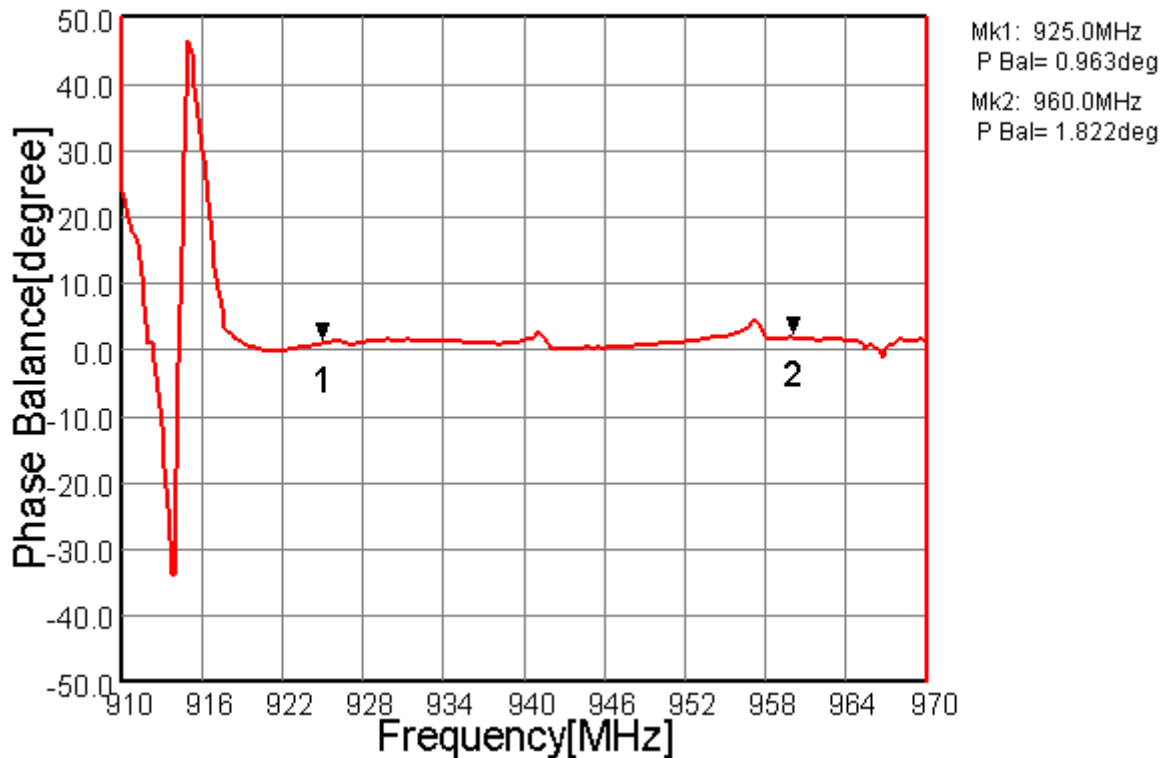


Fig.8 Phase Balance