

# SBD Type : FCQ20A04

## OUTLINE DRAWING

### FEATURES

- \*Similar to TO-220AB Case
- \*Fully Molded Isolation
- \*Dual Diodes – Cathode Common
- \*Low Forward Voltage Drop
- \*High Surge Capability
- \*T<sub>j</sub>=150 °C operation

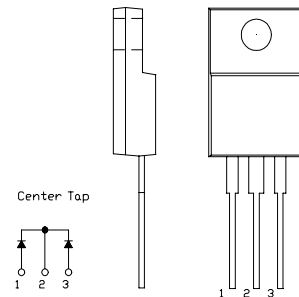

### Maximum Ratings

Approx Net Weight: 1.75g

Rating	Symbol	FCQ20A04			Unit
Repetitive Peak Reverse Voltage	V <sub>RRM</sub>	40			V
Average Rectified Output Current	I <sub>O</sub>	20	T <sub>c</sub> =119°C	50 Hz Full Sine Wave Resistive Load	A
RMS Forward Current	I <sub>F(RMS)</sub>	22.2			A
Surge Forward Current	I <sub>FSM</sub>	180	50Hz Full Sine Wave ,1cycle Non-repetitive		A
Operating JunctionTemperature Range	T <sub>jw</sub>	-40 to +150			°C
Storage Temperature Range	T <sub>stg</sub>	-40 to +150			°C
Mounting torque	F <sub>tor</sub>	recommended torque = 0.5			N•m

### Electrical • Thermal Characteristics

Characteristics	Symbol	Conditions	Min.	Typ.	Max.	Unit
Peak Reverse Current	I <sub>RM</sub>	T <sub>j</sub> = 25°C, V <sub>RM</sub> = V <sub>RRM</sub> per arm	-	-	10	mA
Peak Forward Voltage	V <sub>FM</sub>	T <sub>j</sub> = 25°C, I <sub>FM</sub> = 10 A per arm	-	-	0.55	V
Thermal Resistance	R <sub>th(j-c)</sub>	Junction to Case	-	-	1.5	°C/W
	R <sub>th(c-f)</sub>	Cace to Fin	-	-	1.5	°C/W

FCQ\_A\_ OUTLINE DRAWING (Dimensions in mm)

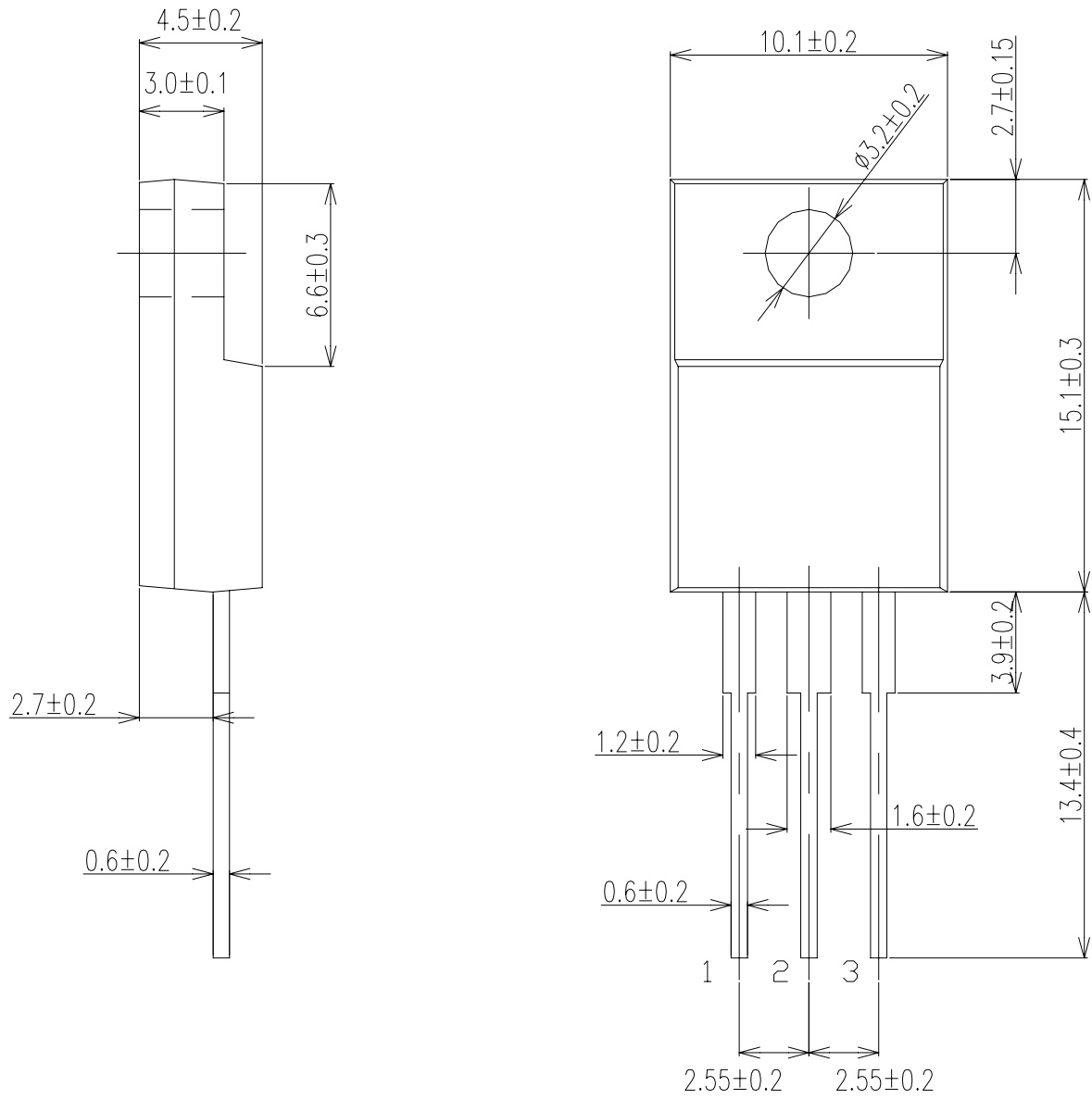

Center Tap

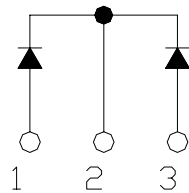

FORWARD CURRENT VS. VOLTAGE

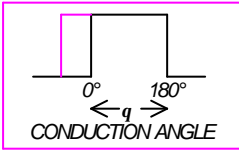
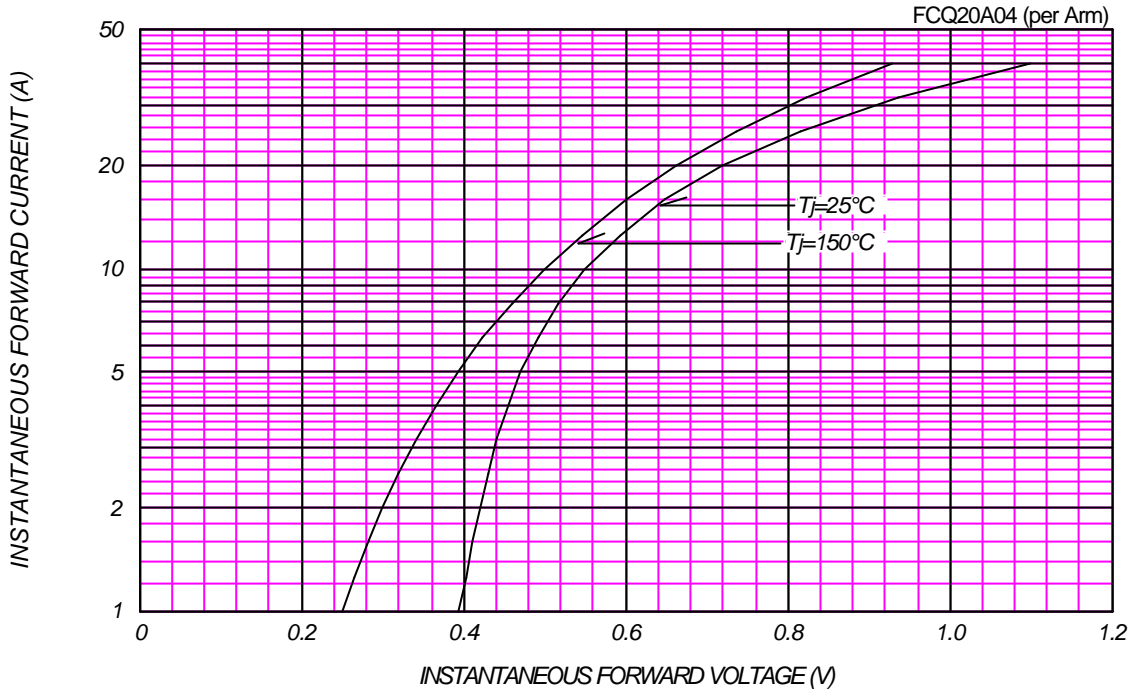

AVERAGE FORWARD POWER DISSIPATION

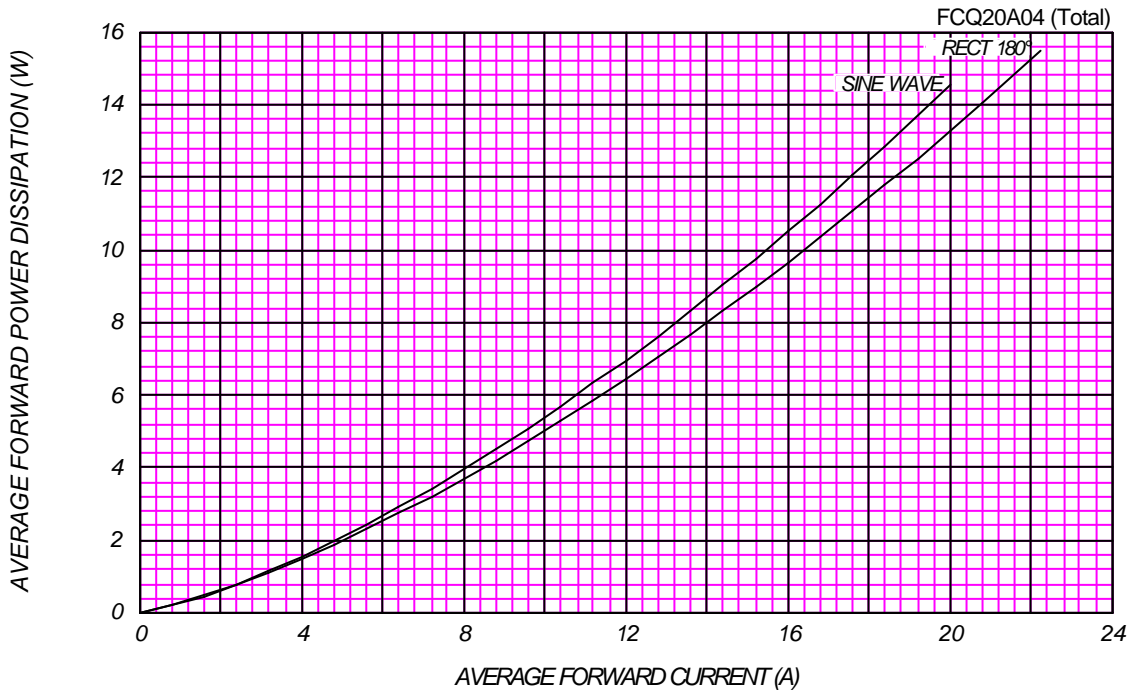

PEAK REVERSE CURRENT VS. PEAK REVERSE VOLTAGE

T<sub>j</sub> = 150 °C

FCQ20A04 (per Arm)

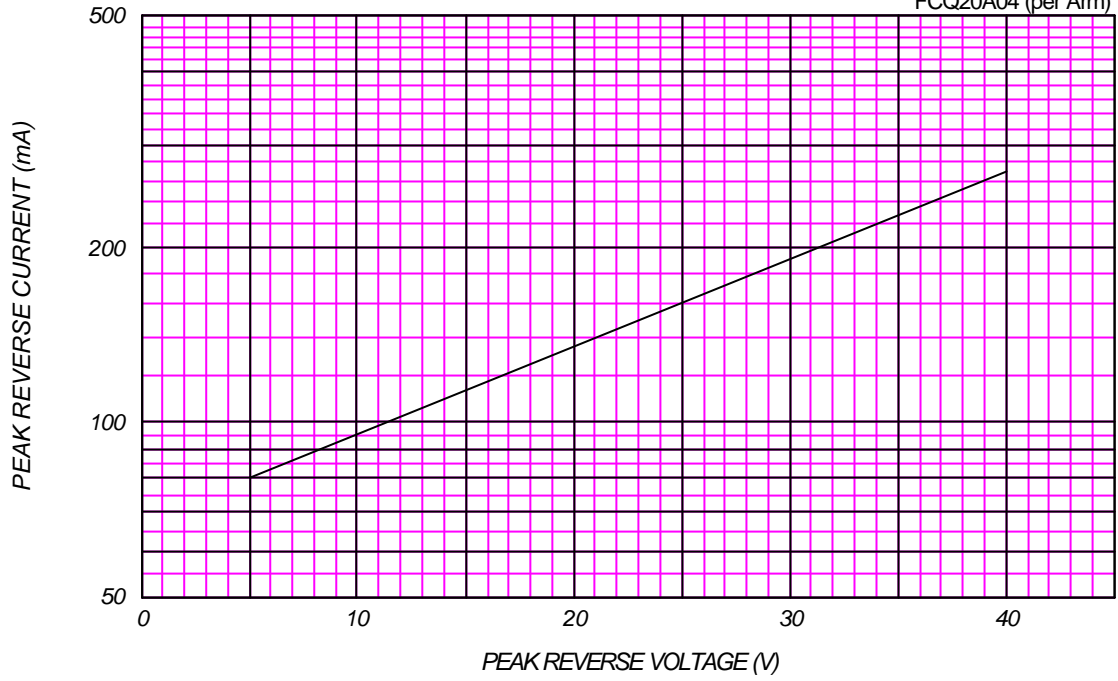

AVERAGE REVERSE POWER DISSIPATION

FCQ20A04 (Total)

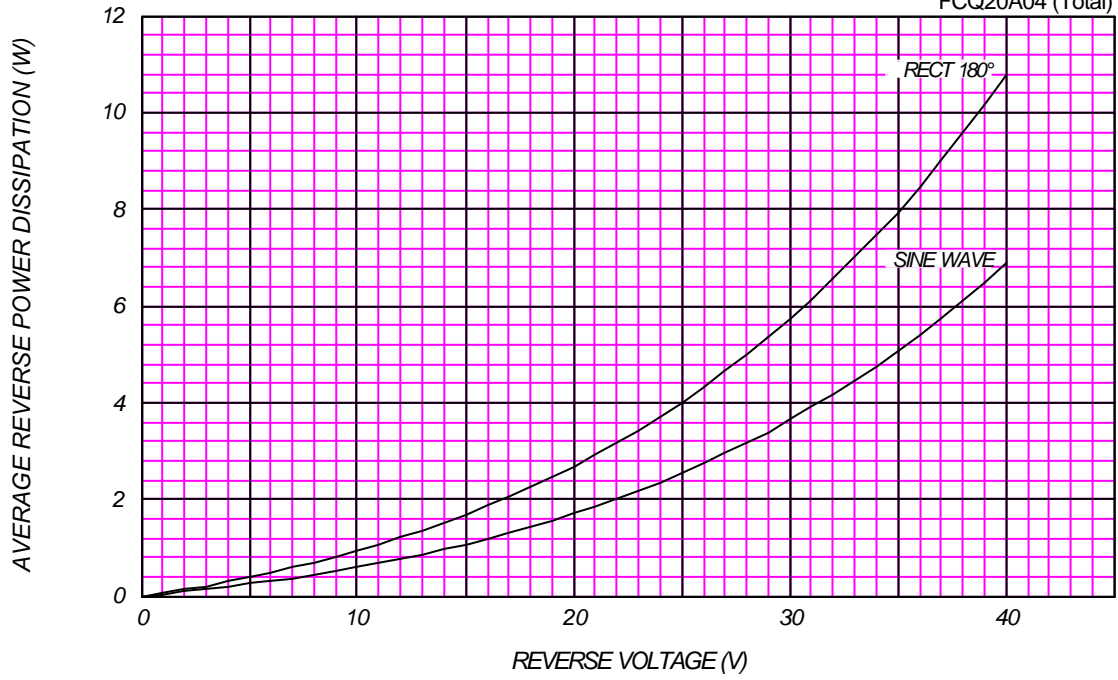



### AVERAGE FORWARD CURRENT VS. CASE TEMPERATURE

$V_{RM}=40V$

FCQ20A04 (Total)

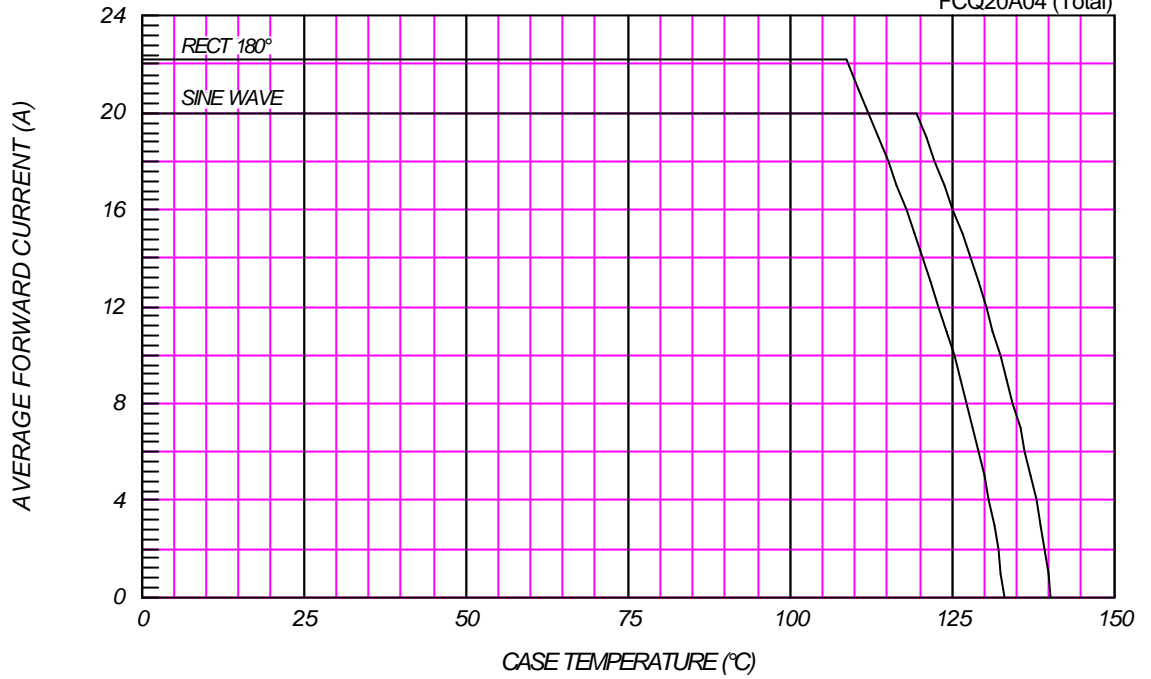

### SURGE CURRENT RATINGS

f=50Hz, Sine Wave, Non-Repetitive, No Load

FCQ20A04

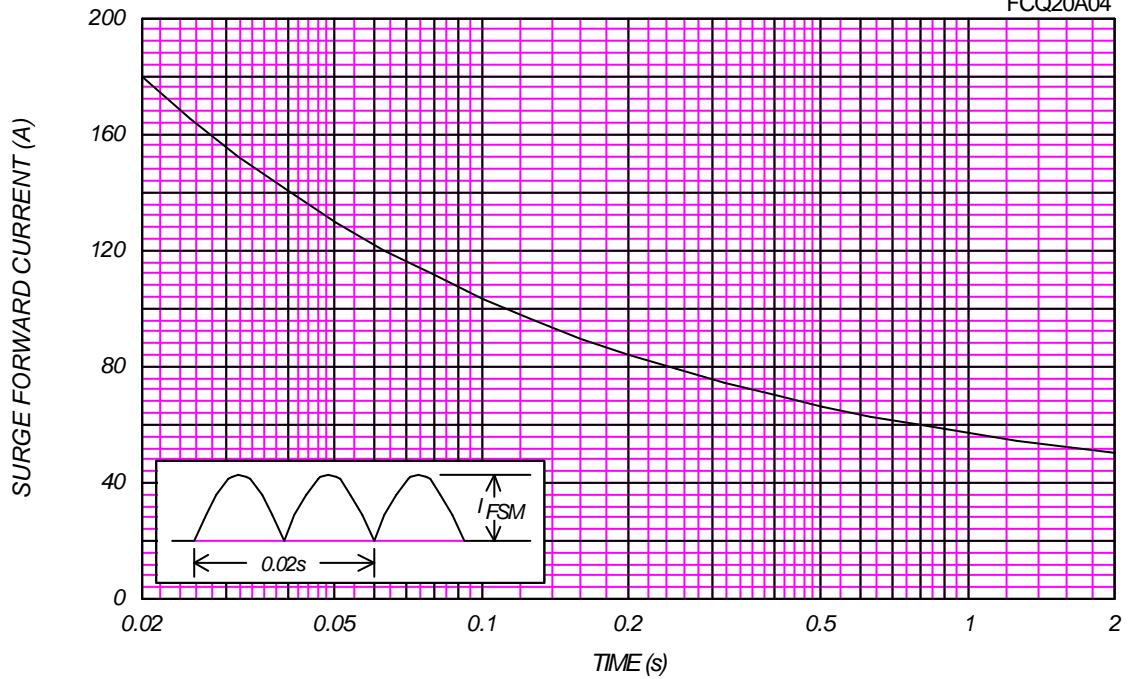

JUNCTION CAPACITANCE VS. REVERSE VOLTAGE

$T_j=25^\circ\text{C}$ ,  $V_m=20\text{mV}_{\text{RMS}}$ ,  $f=100\text{kHz}$ , Typical Value

FCQ20A04 (per Arm)

