

**Smart motor driver with embedded Hall sensor**

**Features**

- Motor driver with integrated Hall sensor
- High current driving capability
- Lock-shutdown protection & auto-restart function
- Built-in RD(rotation detection) signal output
- “Soft-switch” phase-switching technique to reduce vibration and acoustic noise
- Thermal shutdown protection
- PWM speed control(only available for FD0256f)
- Available in both TS825(FD0252f) and TS826(FD0256f) packages



**General Description**

FD0252f/FD0256f is a single coil motor driver with embedded Hall sensor. It integrates the motor driver with the Hall sensor, which simplifies the PCB(printed circuit board) design and make the fabrication of small-size motors possible.

Lock-shutdown and auto-restart function keeps the motor from being over-heated and restarts the motor after being locked.

FD0252f/FD0256f is built-in the signal output of rotation detection function, the system could detect the rotation status from this signal of motor when using FD0252f/FD0256f.

“Soft-switch” phase-switching technique is used to reduce the vibration and acoustic noise.

Thermal-shutdown protection ensures the motor driver to operate under specified temperature ranges.

All the protection mechanisms mentioned above combine to provide a complete protecting scenario for the motor system, keep the motor system from possible damages and guarantee correct operations.

**Block Diagram**

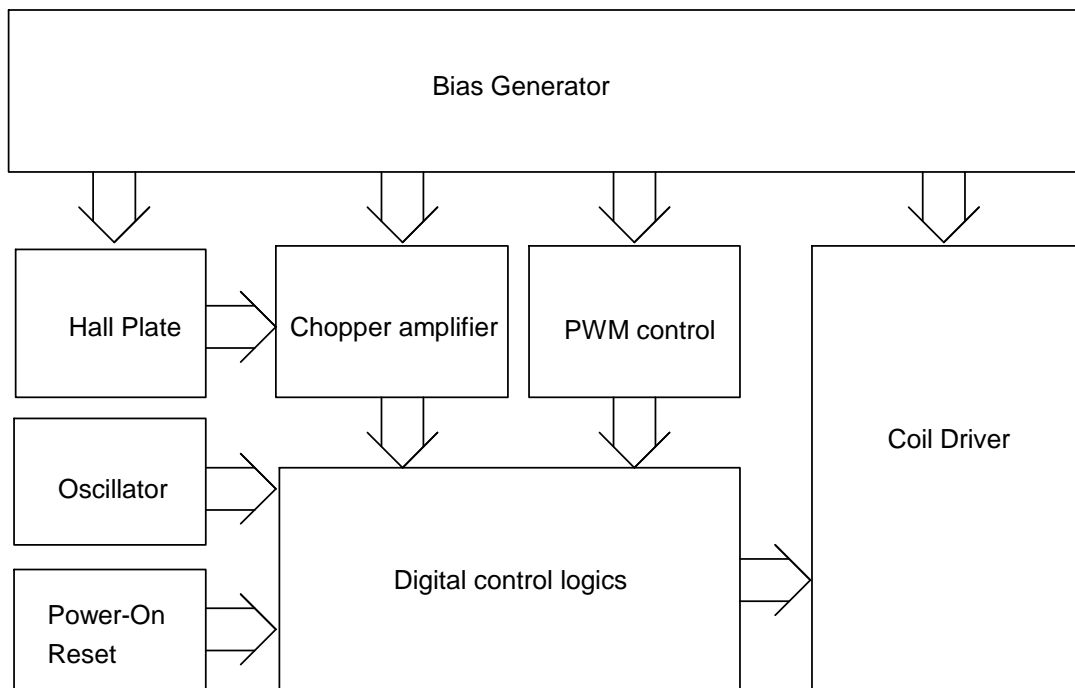

**Figure.1**

## Pin Connection

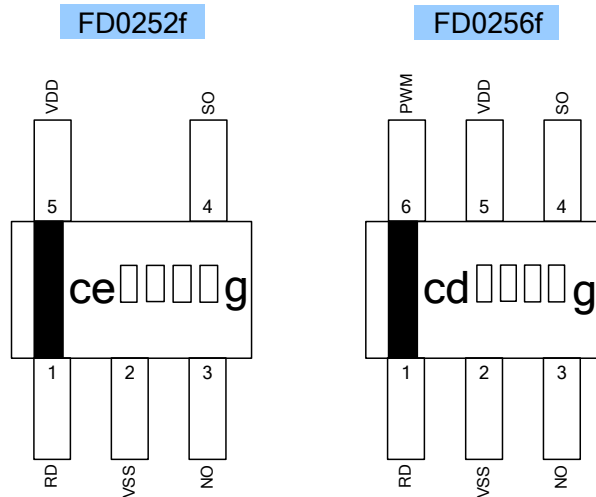

Figure.2

## Pin Descriptions

Name	I/O	FD0252f	FD0256f	Description
RD	O	1	1	Rotation detection
VSS	G	2	2	Ground
NO	O	3	3	Driver output
SO	O	4	4	Driver output
VDD	P	5	5	Positive power supply
PWM	I	-	6	Pulse Width Modulation speed control

Legend: I=input, O=output, I/O=input/output, P=power supply, G=ground

## Functional Descriptions

Refer to the block diagram (Figure.1), FD0252f/FD0256f is composed of the following building blocks:

- Bias Generator

The bias generator provides precise, temperature- and process-insensitive bias references for the analog blocks. These references guarantee proper operation of the IC under all conditions specified in this specification.

- Oscillator

The built-in oscillator provides the clock signal for the digital control logics

- Power-on Reset

Used to detect the power-up ramp and reset the digital circuits.

- Chopper Amplifier

To achieve a higher magnetic sensitivity the chopper amplifier structure is adopted in this design. Use of this structure dynamically removes both the offset and flicker noise at the same time.

- Digital control logics

- Hall sensor part – generates controlling signals for the Hall sensor.
- Coil driver part – generates controlling signals for the Coil driver.
- Signal part – generates an output signal of the rotation detection(RD).



- PWM control

PWM(pulse-width modulation) is used for the speed control for FD0256f. 2 types of PWM input signals can be used :

1. Voltage mode PWM :

Applying a constant(DC) voltage to the PWM pin and the FD0256f will generate PWM pulses internally with the "ON" duty cycle ratio according to the diagram below(Figure.3), which can be utilized by the user to control the speed of the motor. The rotation speed will be higher if the voltage applied to the PWM pin is higher.

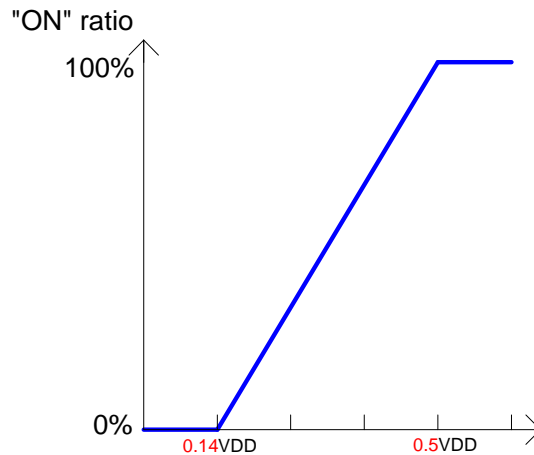

**Figure.3**

2. Pulse mode PWM :

User can also apply PWM pulses directly to the PWM pin. The FD0256f will pass this pulse to the coil driver with the original duty-cycle ratio.

Note:

- (1) This function is only available for FD0256f
- (2) While using pulse mode PWM, the "High" Value of the input pulse should be higher than  $0.5 \cdot VDD$  and the "Low" value should be lower than  $0.14 \cdot VDD$
- (3) The lower-limit for the PWM pulse frequency is 200Hz, and the recommended frequency range is higher than 30KHz where the PWM input pulses will not generate acoustic noise.

**Note.** The "PWM" pin contains an internal pull-up resistor so the FD0256f will rotate at full-speed(100% ON) when this pin is left un-connected(floating).

**Absolute Maximum Ratings**

Parameter	Symbol	Conditions	Values			Unit
			min.	typ.	max.	
Operating Temperature	T <sub>OP</sub>	-	-20		105	°C
Storage Temperature	T <sub>ST</sub>	-	-40		150	°C
DC Supply Voltage	V <sub>DD</sub> , V <sub>RD</sub>	-			6.5	V
PWM Voltage Range	PWM <sub>HIGH</sub>	-	>0.5V <sub>DD</sub>		6.5	V
	PWM <sub>LOW</sub>	-	0		<0.14V <sub>DD</sub>	V
Supply Current	I <sub>DD</sub>	-			3	mA
Continuous Current	I <sub>CONT</sub>	-			500	mA
Hold Current	I <sub>HOLD</sub>	-			800	mA
RD Pin Sink Current	I <sub>RD</sub>	-			25	mA
Junction Temperature	T <sub>J</sub>	-			170	°C
Maximum Power Dissipation	P <sub>DTS825</sub>	-			500	mW
	P <sub>DTS826</sub>	-			520	mW
Thermal Resistance (note1)	θ <sub>ja</sub>	TS825		0.290		°C/mW
		TS826		0.278		°C/mW
Thermal Resistance (note1)	θ <sub>jc</sub>	TS825		0.020		°C/mW
		TS826		0.018		°C/mW
Magnetic Flux Density	B				Unlimited	Gauss
IR-Reflow Lead Temperature	T <sub>P</sub>	10sec			260	°C

**Note1:** device mounted with copper area of approximately 10mm<sup>2</sup>, 1ØZ, no air flow. (room temperature: 25 °C)

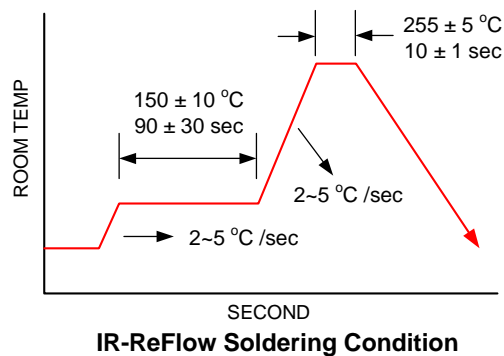
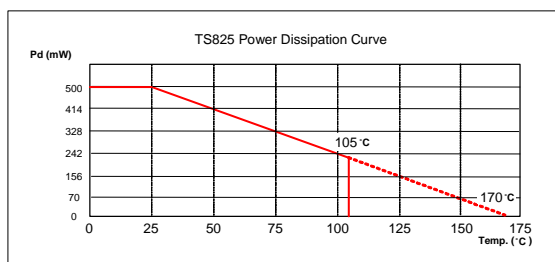
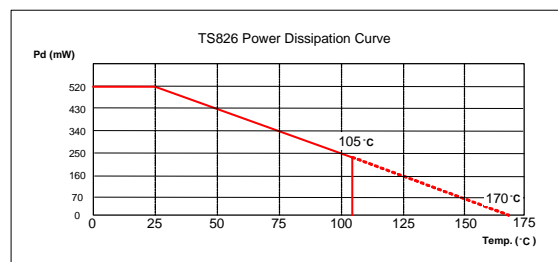
**Figure.4**

**Figure.5**

**Figure.6**

**Recommended Operating Conditions**

Parameter	Conditions	Values			Unit
		min.	typ.	max.	
Supply Voltage	-	1.8		5.5	V
Ambient Temperature	-	-10		90	°C

**Electrical Characteristics  $V_{DD}=5.0V$ ,  $T_A=25^\circ C$  (unless otherwise specified)**

Parameter	Conditions	Values			Unit
		min.	typ.	max.	
Average Supply Current(no load)			1.8		mA
Output Saturation Voltage(RD)	$I_{RD}=10mA$			0.5	V
Output Leakage Current(RD)	$V_{RD}=5V$			1	$\mu A$
On Resistance( $R_{pmos}+R_{nmos}$ )			0.8		$\Omega$
Thermal Shutdown Threshold			165		°C

**Magnetic Characteristics**

Parameter	Conditions	Values			Unit
		min.	typ.	max.	
Operate Points ( $B_{OP}$ )			25		G
Release Points ( $B_{RP}$ )			-25		G
Hysteresis			50		G

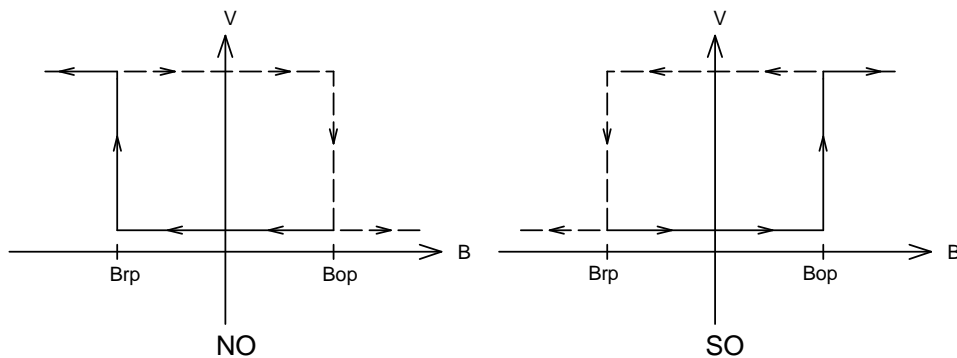
**Hysteresis Characteristics**

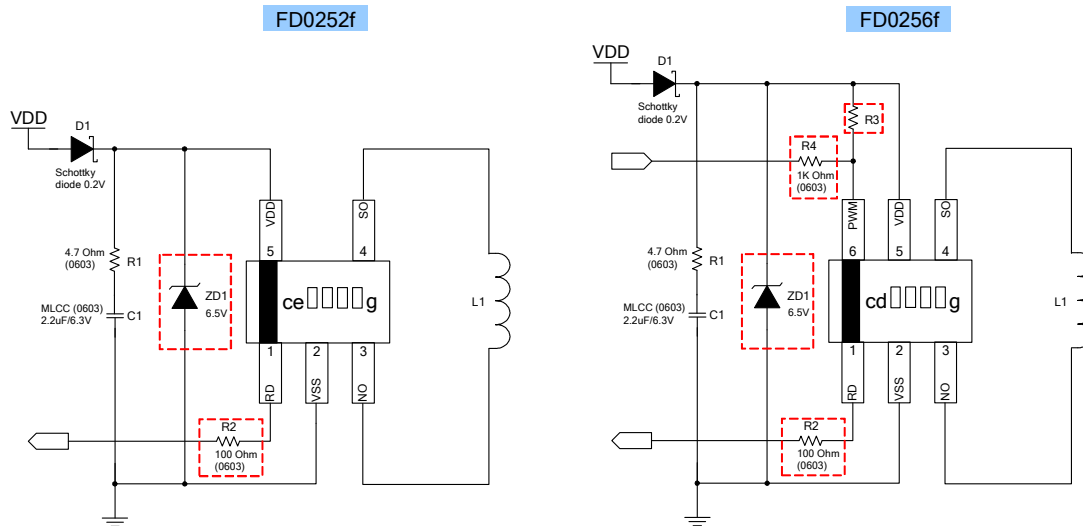
**Figure.7**

**Application Circuit Reference**

**Figure.8**
**Note:**

Must use C1 capacitor for the decoupling between  $V_{DD}$  and  $V_{SS}$  and place the capacitor as close to the IC as possible.

  Option component

1. ZD1:  $V_{DD}$  over-voltage stress protection diode.
2. R2: current limit resistor for Open Drain RD output.
3. R3: PWM Pull-up resistor for Open Drain PWM source signal.
4. R4: de-coupling resistor for long-distance signal transmission.



## Output Waveforms Description

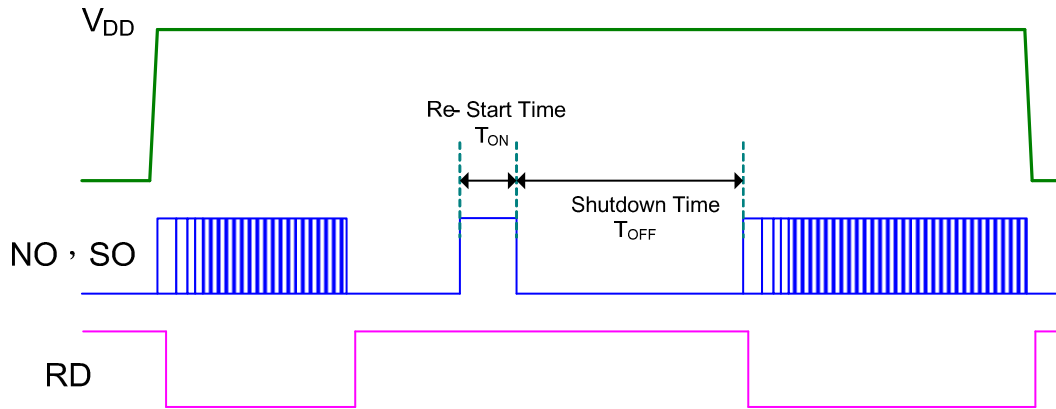
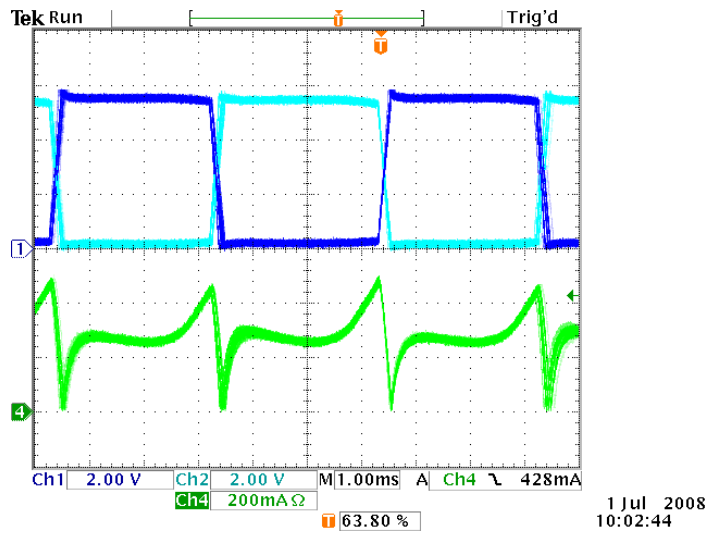

Figure.9 FD0252/0256f Operation Waveforms Description

### Note:

1. RD is an open drain output and the high level of the signal depends on the external supply voltage.
2. The on torque time of motor is same as the re-start time.

**FD0252/0256 Output Waveforms Measurement**

**CH1: NO Output**  
**CH2: SO Output**  
**CH4: Input Current**

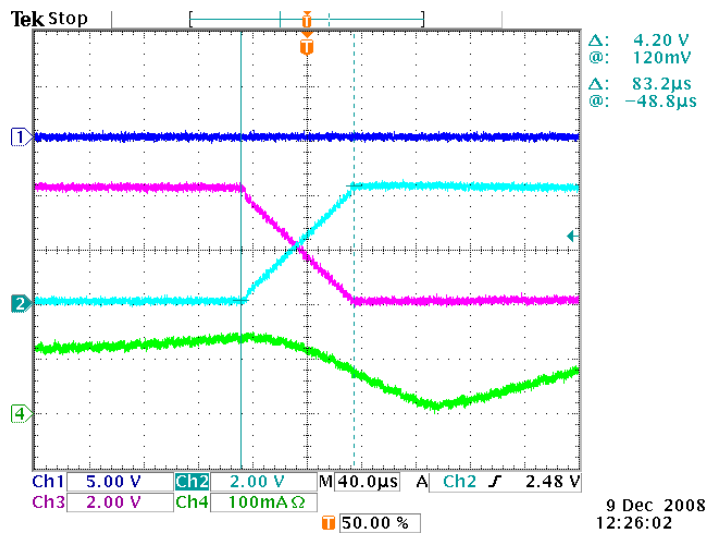
**Figure.10 Normal Operation Waveforms (FD0252f / FD0256f full speed mode)**

**CH1: RD Output**  
**CH2: NO Output**  
**CH3: SO Output**  
**CH4: Input Current**

**Figure.11 Soft-Switching Waveforms (FD0252f / FD0256f full speed mode)**



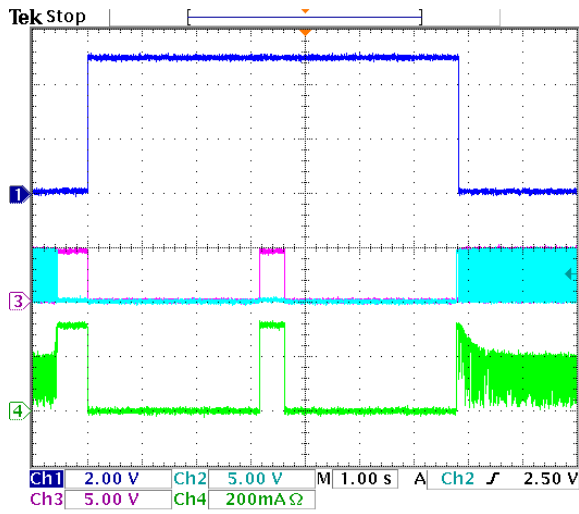

CH1: RD Output  
CH2: NO Output  
CH3: SO Output  
CH4: Input Current

9 Dec. 2008  
12:31:29

Figure.12 Rotor Lock and Release Waveforms (FD0252f / FD0256f full speed mode)

The IC laying aside mode declaration is as follows

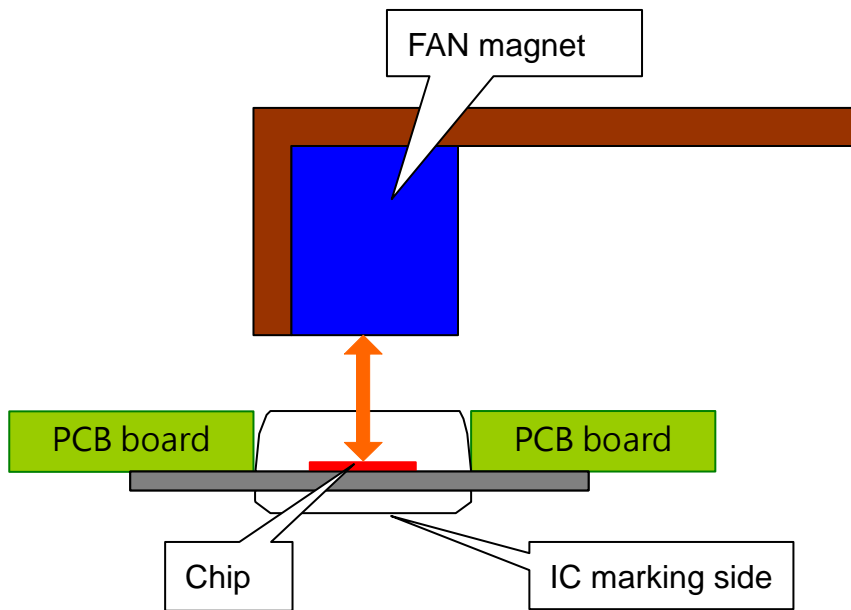

**Figure.13 Motor Cross Section and distance with IC sensor**

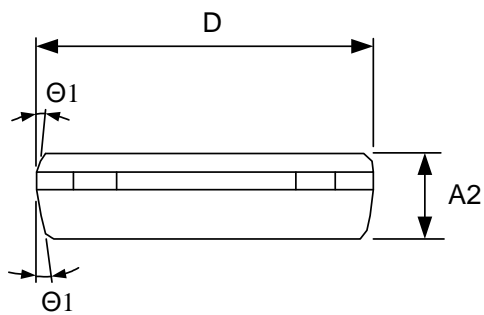
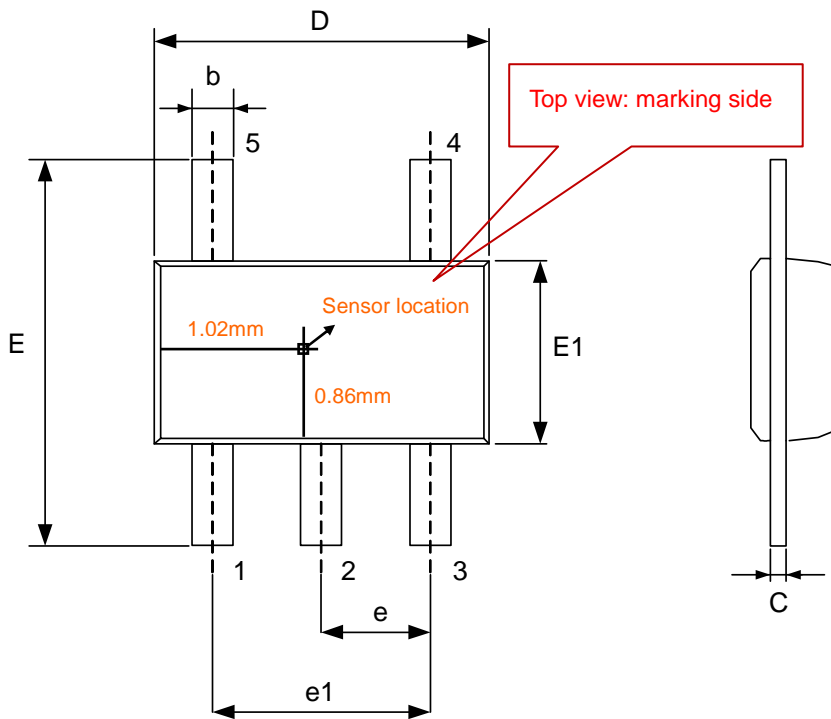
**Package Dimension (Unit: mm)**  
**TS825 (Halogen Free)**

Symbols	Dimension In Millimeters		
	Min	Nom	Max
A2	0.700	0.750	0.775
b	0.350	-	0.500
c	0.100	-	0.200
D	2.800	2.900	3.100
E	3.700	3.800	3.900
E1	1.500	1.600	1.700
e	0.950 BSC		
e1	1.900 BSC		
Θ1	4°	10°	12°



**Package Dimension (Unit: mm)**  
**TS826 (Halogen Free)**

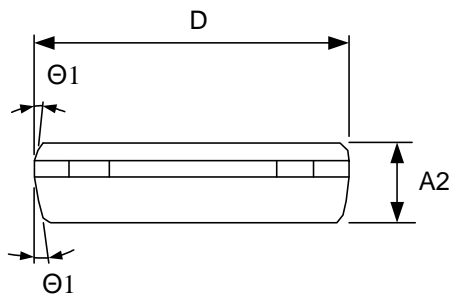
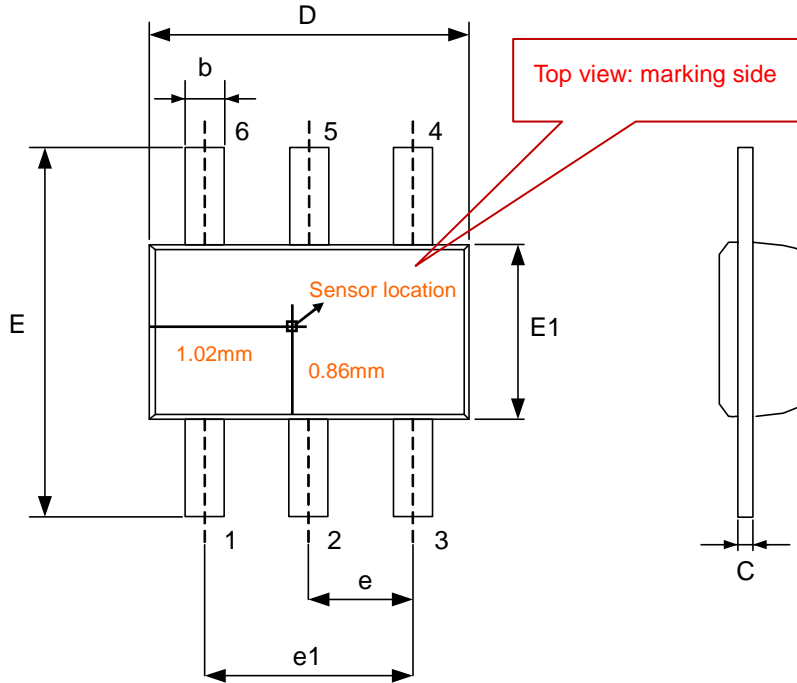

Symbols	Dimension In Millimeters		
	Min	Nom	Max
A2	0.700	0.750	0.775
b	0.350	-	0.500
c	0.100	-	0.200
D	2.800	2.900	3.100
E	3.700	3.800	3.900
E1	1.500	1.600	1.700
e	0.950 BSC		
e1	1.900 BSC		
Θ1	4°	10°	12°



## Packing Specification (Tapping Reel)

### TS825

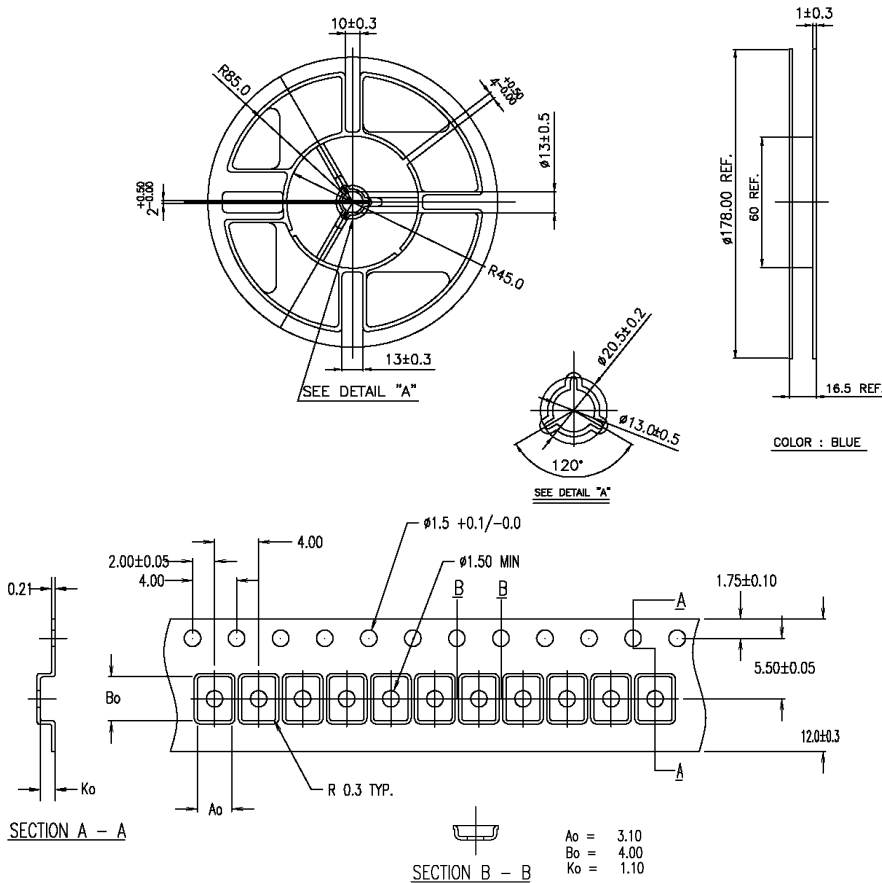

COLOR : BLUE

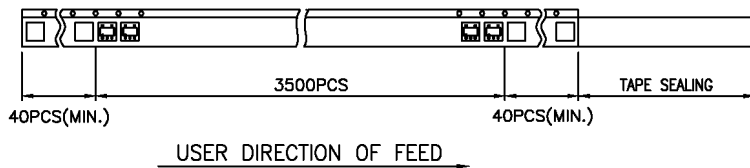

Top view: marking side

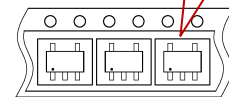

TSOT-25 (F/P : 2.2mm 平脚)

包装方式 : 3500 EA/PER REEL

### Notes:

1. 10 sprocket hole pitch cumulative tolerance  $\pm 0.2$ mm
2. Camber not to exceed 1mm in 100mm.
3. Material: Anti-Static Black Advantek Polystyrene.
4.  $A_o$  and  $B_o$  measured on a plane 0.3mm above the bottom of the pocket.
5.  $K_o$  measured from a plane on the inside bottom of the pocket to the top surface of the carrier.
6. Pocket position relative to sprocket hole measured as true position of pocket, not pocket hole.



## TS826

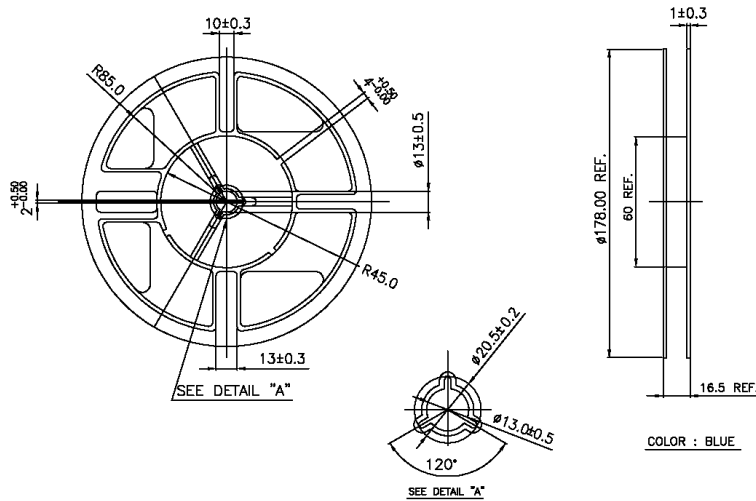

COLOR : BLUE

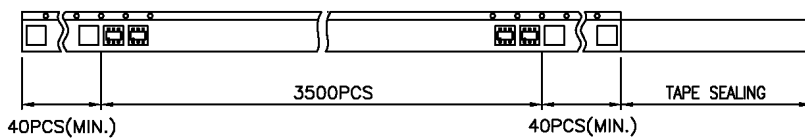
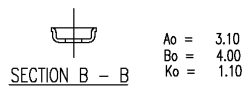
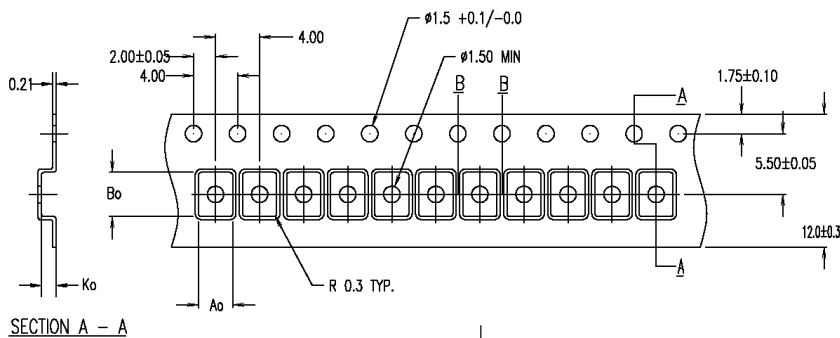

### USER DIRECTION OF FEED

1. 10 sprocket hole pitch cumulative tolerance  $\pm 0.2\text{mm}$
2. Camber not to exceed 1mm in 100mm.
3. Material: Anti-Static Black Advantek Polystyrene.
4. Ao and Bo measured on a plane 0.3mm above the bottom of the pocket.
5. Ko measured from a plane on the inside bottom of the pocket to the top surface of the carrier.
6. Pocket position relative to sprocket hole measured as true position of pocket, not pocket hole.

Top view: marking side

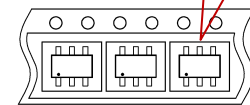

TSOT-26 (F/P : 2.2mm 平脚)

包装方式: 3500 EA/PER REEL

**PACKING QUANTITY SPECIFICATION**

3,500ea / 1 Reel

3 Reels / 1 INSIDE BOX

4 INSIDE BOXes / 1 OUTSIDE BOX

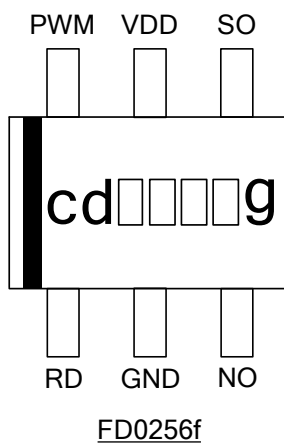
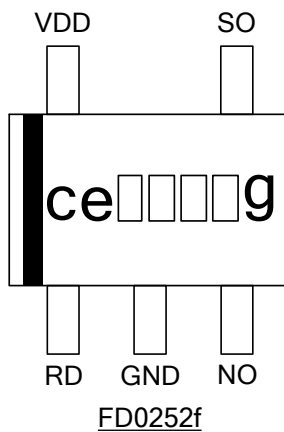
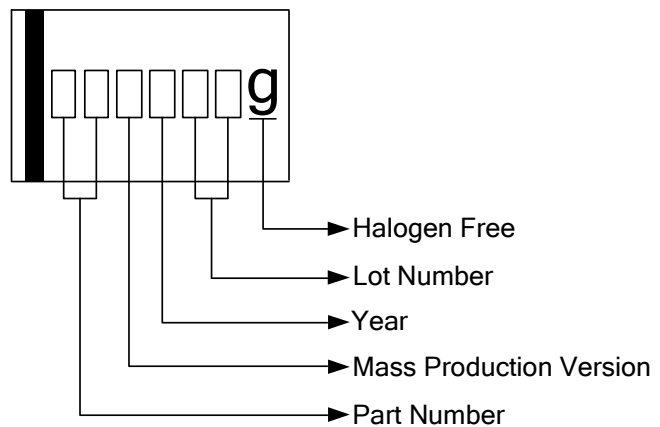
**IC Pin Connection**

**Marking Distinguish**

**Order Information**

Part Number	Package	MOQ	Marking	MSL
FD0252fR-G1	TS825	3,500EA / REEL	ceXXXXg	3
FD0256fR-G1	TS826	3,500EA / REEL	cdXXXXg	