

## Smart motor driver with embedded Hall sensor

### Features

- Motor driver with high sensitivity Hall-effect sensor
- H-Bridge MOS driver
- Lock-shutdown protection & auto-restart function
- Built-in tachometer signal output (FG)
- “Soft-switch” phase-switching technique to reduce vibration and acoustic noise
- Thermal shutdown protection (TSD)
- PWM mode variable speed control
- Available in TS826 package
- For 5V DC motor / FAN systems


 Halogen Free

### General Description

FD0259f is a single-phase full-wave motor driver with embedded Hall-effect sensor. It integrates a H-bridge MOS driver, a high sensitivity Hall-effect sensor, an event timer for locked rotor detection, and the variable speed control function with the tachometer or alarm signal output logic into the ultra-small TS826 package, which make the motors' PCB (printed circuit board) design easier and the fabrication of small-size DC motors or FANs as simple as possible.

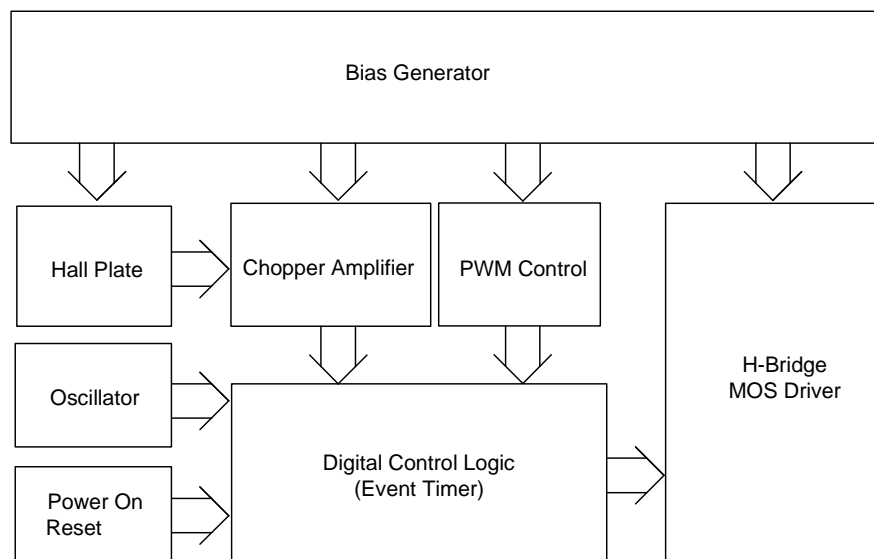
The external system could read the motor's speed of rotation from FG signal of FD0259f.

For safety, Lock-shutdown function turns the IC's internal driver off to avoid over-heating when the rotor is locked, and the IC will try to re-start the motor after the shutdown interval.

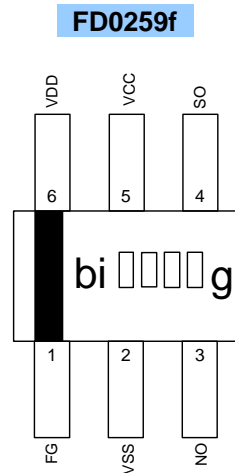
Thermal-shutdown protection (TSD) ensures the internal driver of IC is operating under the safe operating temperature range.

All the protection mechanisms mentioned above combine to provide a complete protecting scenario in the motor system and avoid any possible damages and guarantee under a correct and safe operation.

### Block Diagram



**Figure.1**

**Pin Connection**

**Figure.2**
**Pin Descriptions**

Name	I/O	FD0259f	Description
FG	O	1	Tachometer Signal Output
VSS	G	2	Ground
NO	O	3	Driver Output 1
SO	O	4	Driver Output 2
VCC	P	5	Positive Power Supply
VDD	P	6	Positive Power Supply

Legend: I=input, O=output, I/O=input/output, P=power supply, G=ground

**Functional Descriptions**

Refer to the block diagram (Figure.1), FD0259f is composed of the following building blocks:

- Bias generator

The bias generator provides precise, temperature- and process-insensitive bias references for the analog blocks. These references guarantee proper operation of the IC under all conditions specified in this specification.

- Oscillator

The built-in oscillator provides the clock signal for the digital control logic.

- Power On Reset

Used to detect the power-up ramp and reset the digital circuits.

- Chopper Amplifier

To achieve a higher magnetic sensitivity the chopper amplifier structure is adopted in this design. Use of this structure dynamically removes both the offset and flicker noise at the same time.

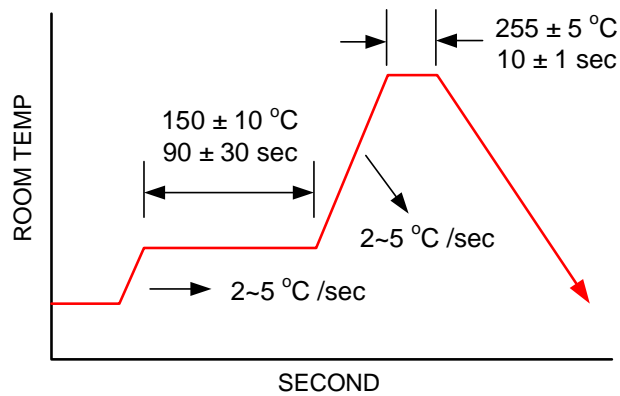
- Digital Control Logic

- Hall sensor part – generates magnetic pole signals from the Hall-effect sensor.
- Driver part – generates switching signals to the H-Bridge MOS driver.
- Timer part – generates an interval of time when rotor locked event is occurred.
- Signal part – generates a tachometer signal(FG) output.

**Absolute Maximum Ratings**

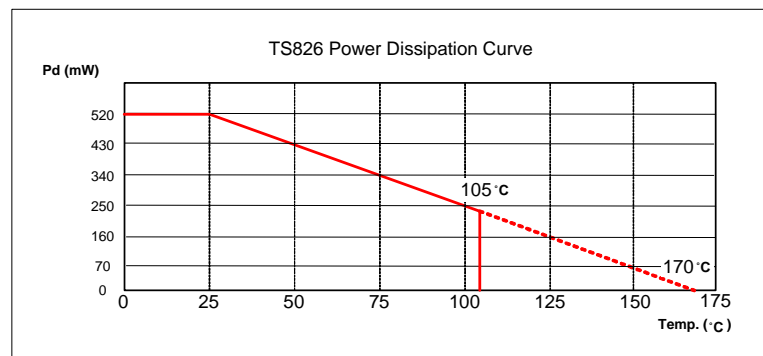
Parameter	Symbol	Conditions	Values			Unit
			min.	typ.	max.	
Operating Temperature	T <sub>OP</sub>	-	-20		105	°C
Storage Temperature	T <sub>ST</sub>	-	-40		150	°C
DC Supply Voltage(V <sub>DD,FG</sub> )	V <sub>DD</sub>	-			6.5	V
PWM Voltage Range	PWM <sub>HIGH</sub>	-			6.5	V
	PWM <sub>LOW</sub>	-	0			V
Supply Current	I <sub>DD</sub>	-			6	mA
Continuous Current	I <sub>CONT</sub>	-			500	mA
Hold current	I <sub>HOLD</sub>	-			800	mA
FG sink current	I <sub>SINK</sub>	-			25	mA
Junction Temperature	T <sub>J</sub>	-			170	°C
Maximum Power Dissipation	P <sub>DTS826</sub>	-			520	mW
Thermal resistance (note1)	θ <sub>ja</sub>	TS826		0.278		°C/mW
Thermal resistance (note1)	θ <sub>jc</sub>	TS826		0.018		°C/mW
Magnetic Flux Density	B				Unlimited	Gauss
IR-Reflow Lead Temperature	T <sub>P</sub>	10sec			260	°C

**Note1:** device mounted with copper area of approximately 10mm<sup>2</sup>, 1ØZ, no air flow. (room temperature: 25 °C)



**IR-ReFlow Soldering Condition**

**Figure.3**



**Figure.4**

**Recommended Operating Conditions**

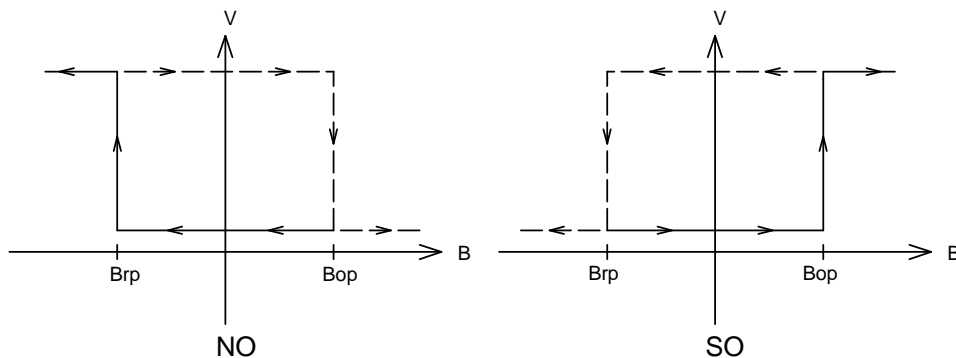
Parameter	Conditions	Values			Unit
		min.	typ.	max.	
Supply Voltage ( $V_{DD}$ )	-	1.8		5.5	V
Ambient Temperature ( $T_a$ )	-	-20		105	°C

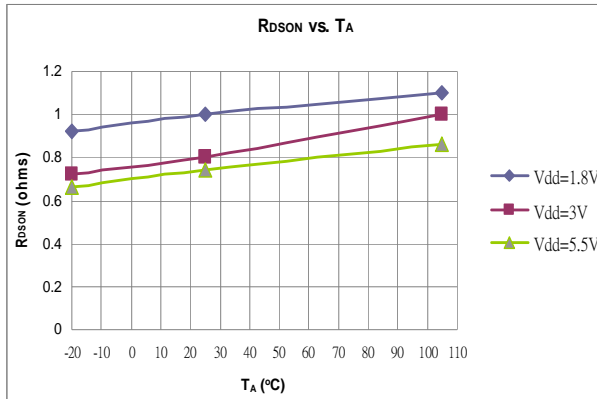
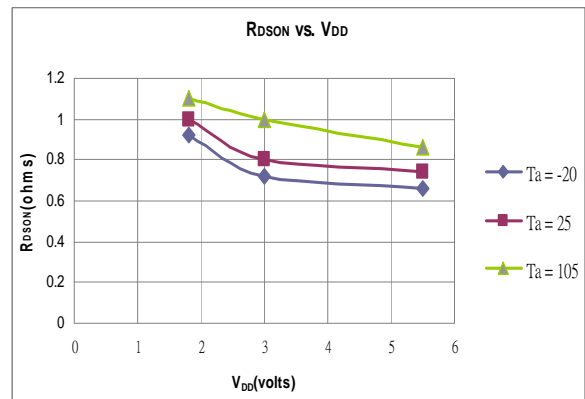
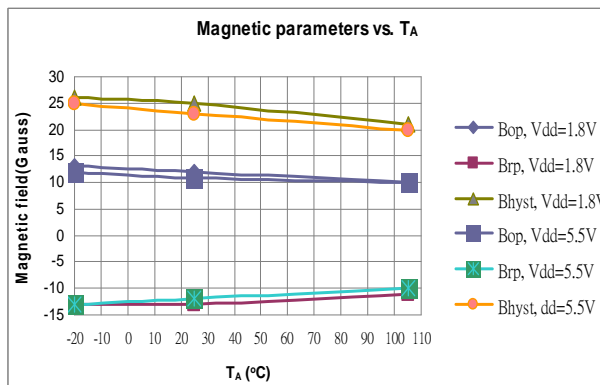
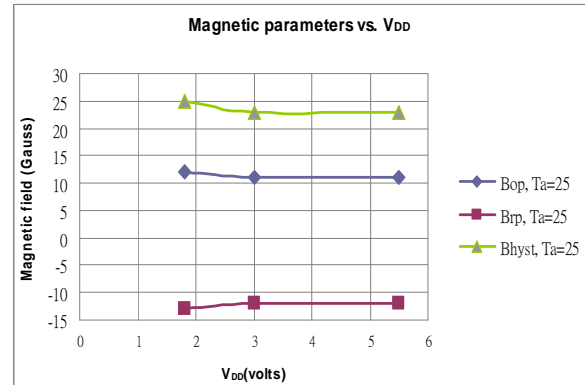
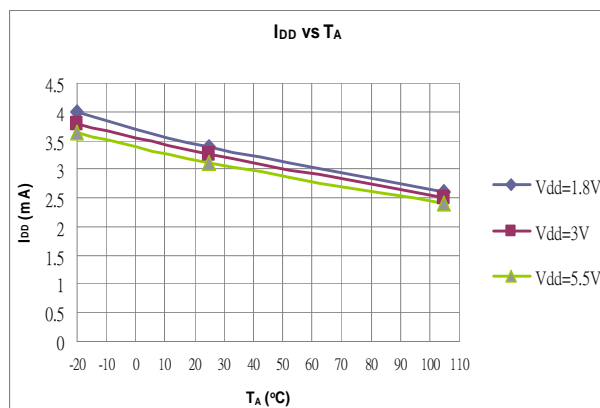
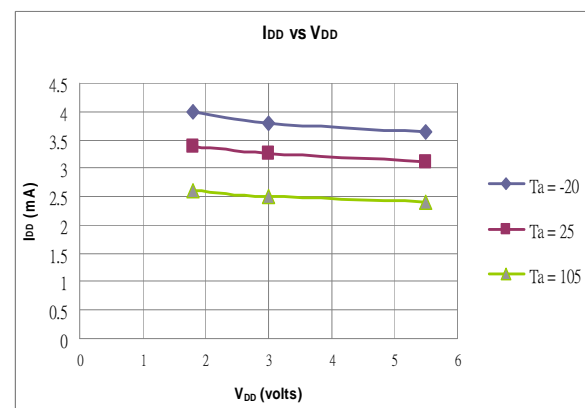
**Electrical Characteristics  $V_{DD}=5.0V$ ,  $T_a=25^\circ C$  (unless otherwise specified)**

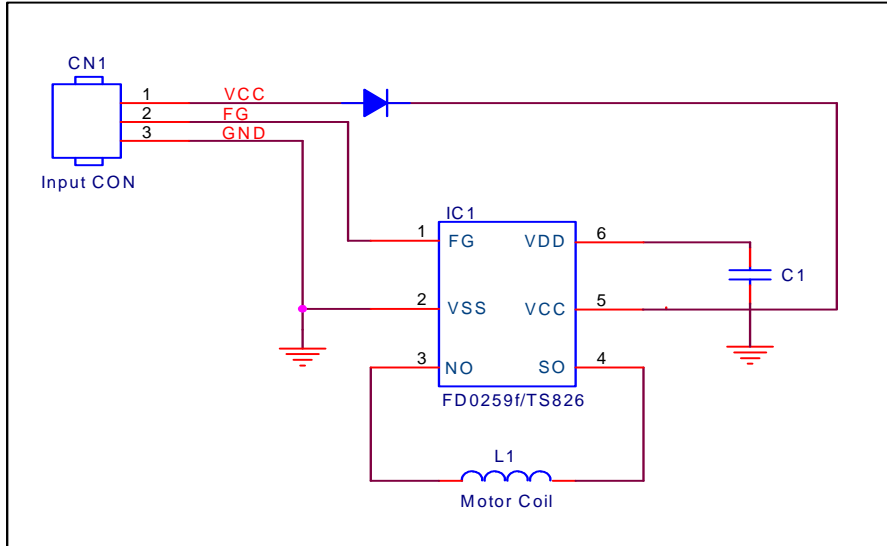
Parameter	Conditions	Values			Unit
		min.	typ.	max.	
Average Supply Current(no load)			3		mA
Output Saturation Voltage(FG)	$I_{out}=5mA$			0.4	V
Output Leakage Current(FG)	$V_{out}=5V$			1	$\mu A$
On resistance( $R_{pmos}+R_{nmos}$ )			0.8		$\Omega$
Thermal Shutdown Threshold		150			°C
Locked Rotor Period( $T_{ON}$ )			0.4		s
Locked Rotor Period( $T_{OFF}$ )			2.8		s

**Magnetic Characteristics**

Parameter	Conditions	Values			Unit
		min.	typ.	max.	
Operate Points( $B_{OP}$ )			15		G
Release Points( $B_{RP}$ )			-15		G
Hysteresis( $B_{HYS}$ )			30		G

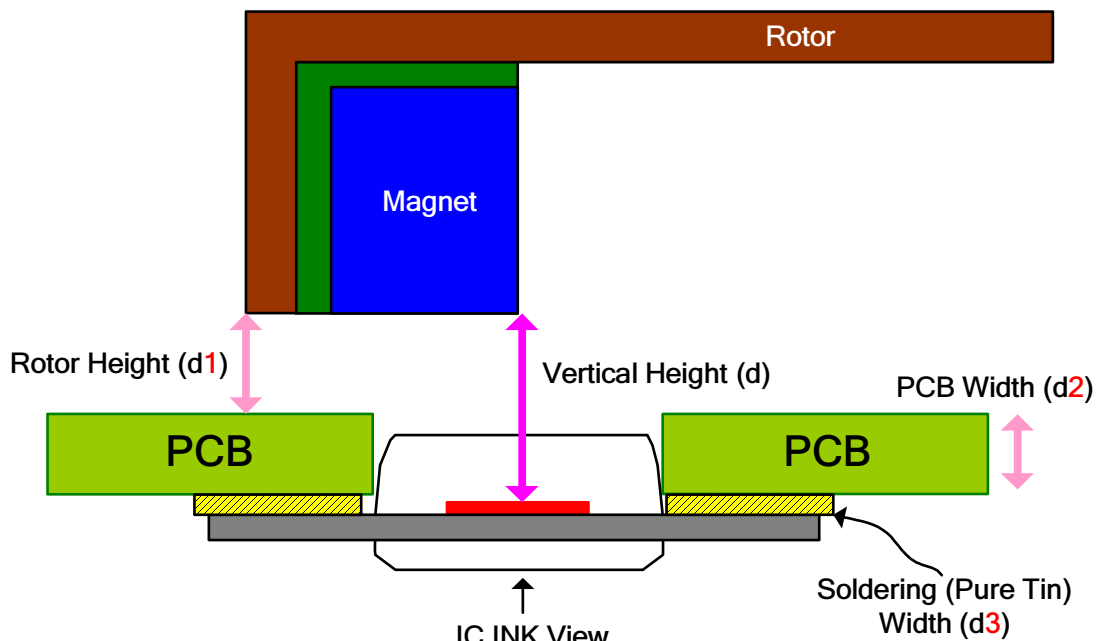
**Hysteresis Characteristics**

**Figure.5**

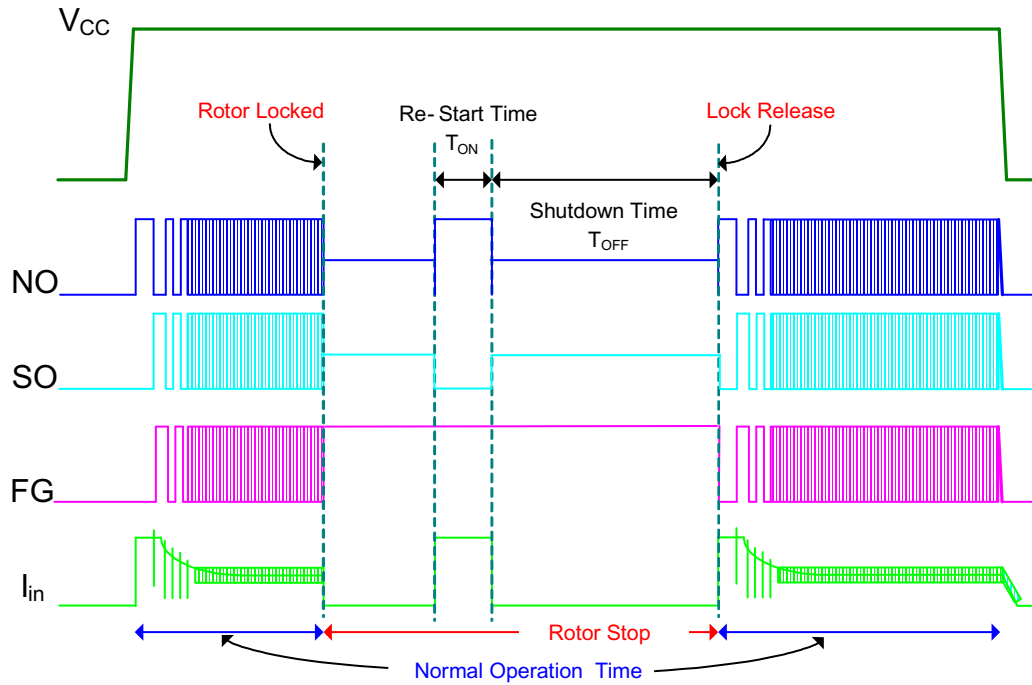
**Performance Graphs**

**Figure.6**

**Figure.7**

**Figure.8**

**Figure.9**

**Figure.10**

**Figure.11**

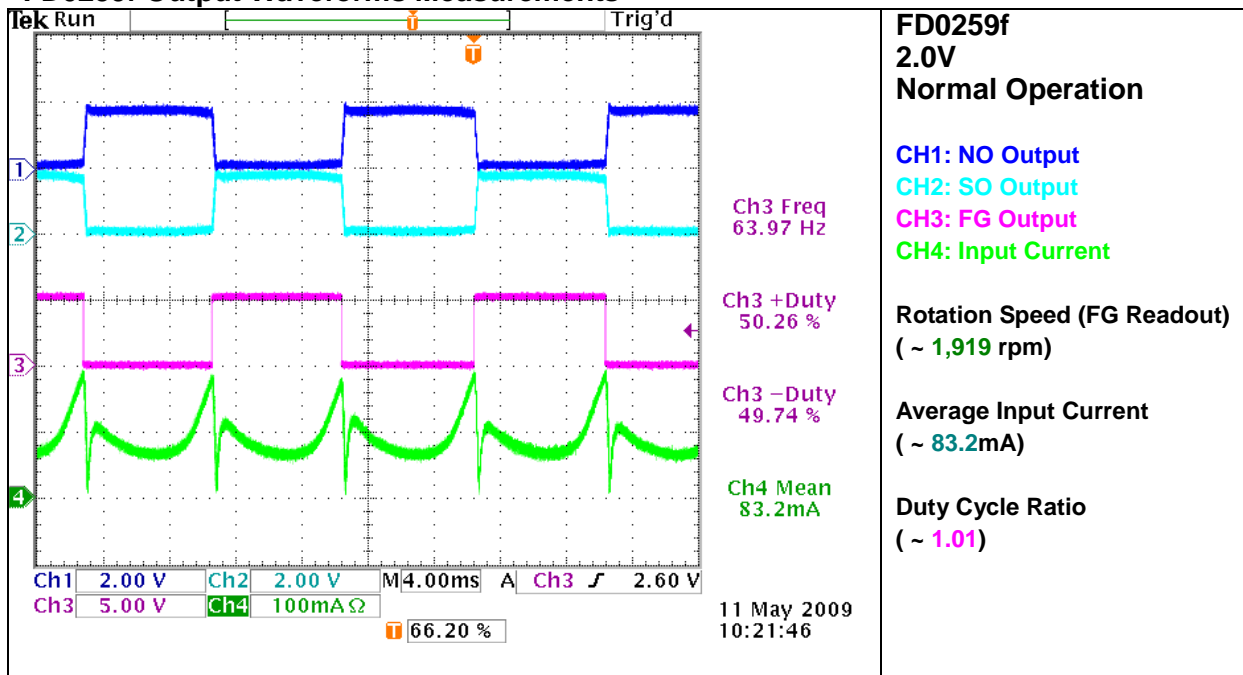
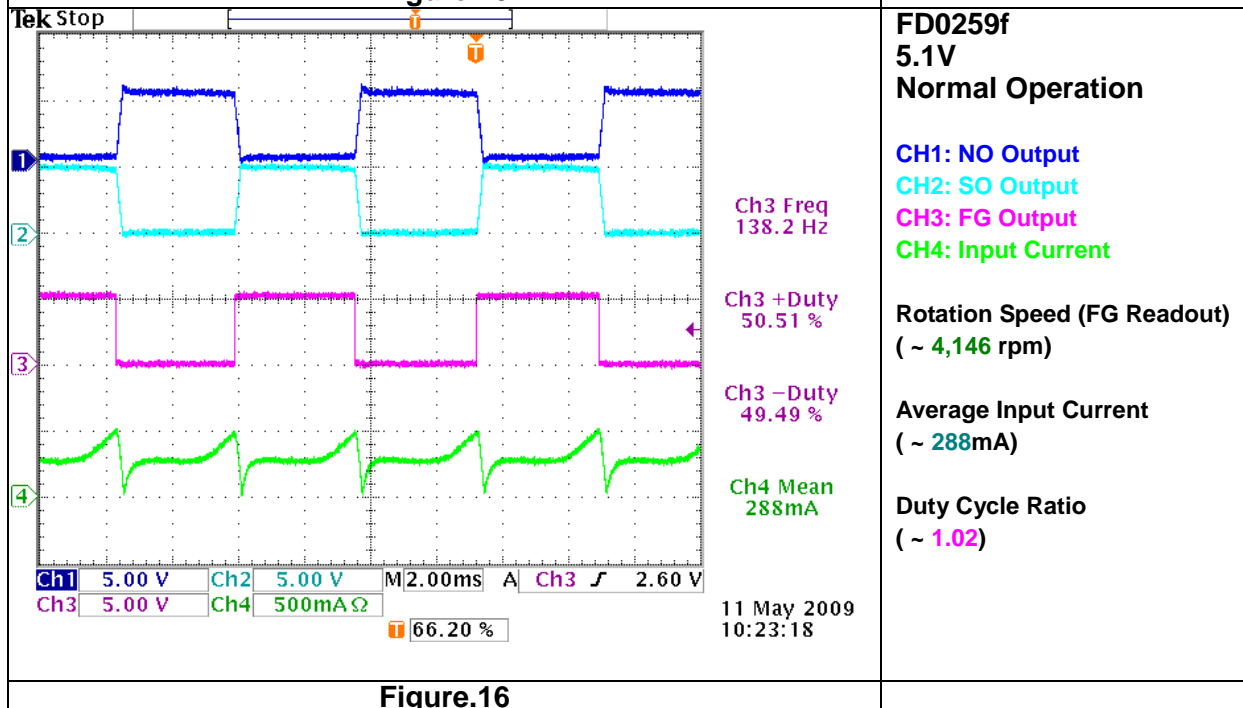
**Application Circuit Reference**

**Figure.12**
**Note:**

1. *D1: better use schottky diodes with lower  $V_{th}$  to improve low-voltage operation.*
2. *place the capacitor C1 as close to the IC as possible.*

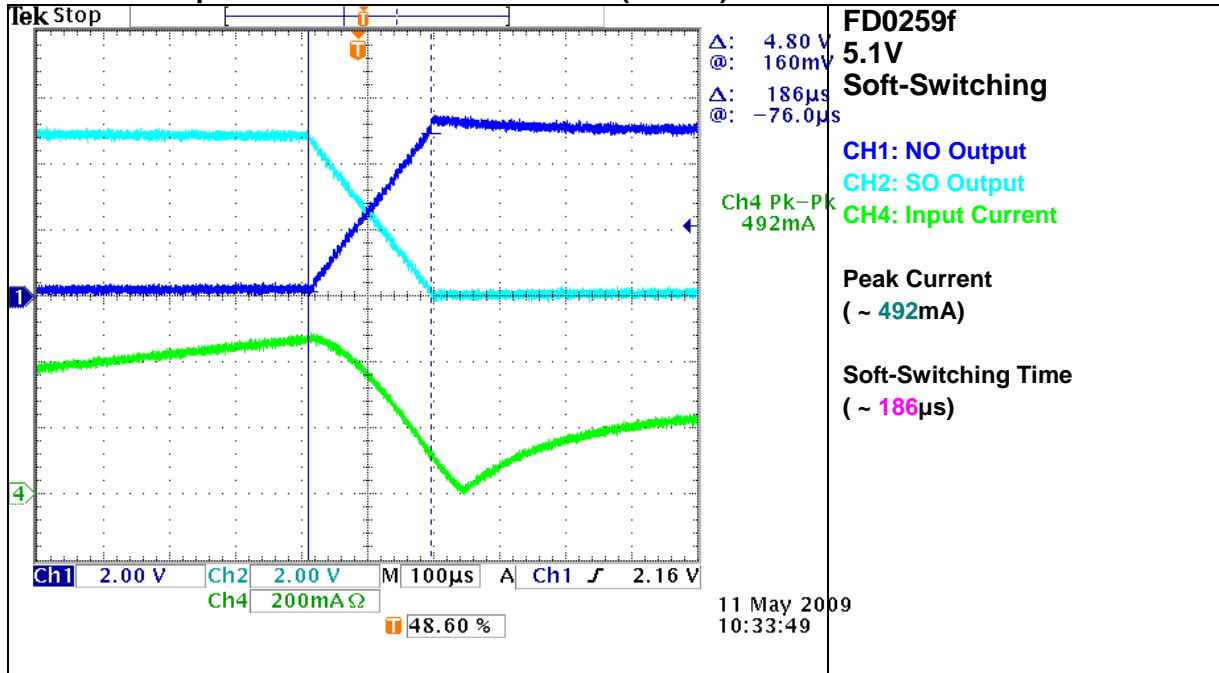
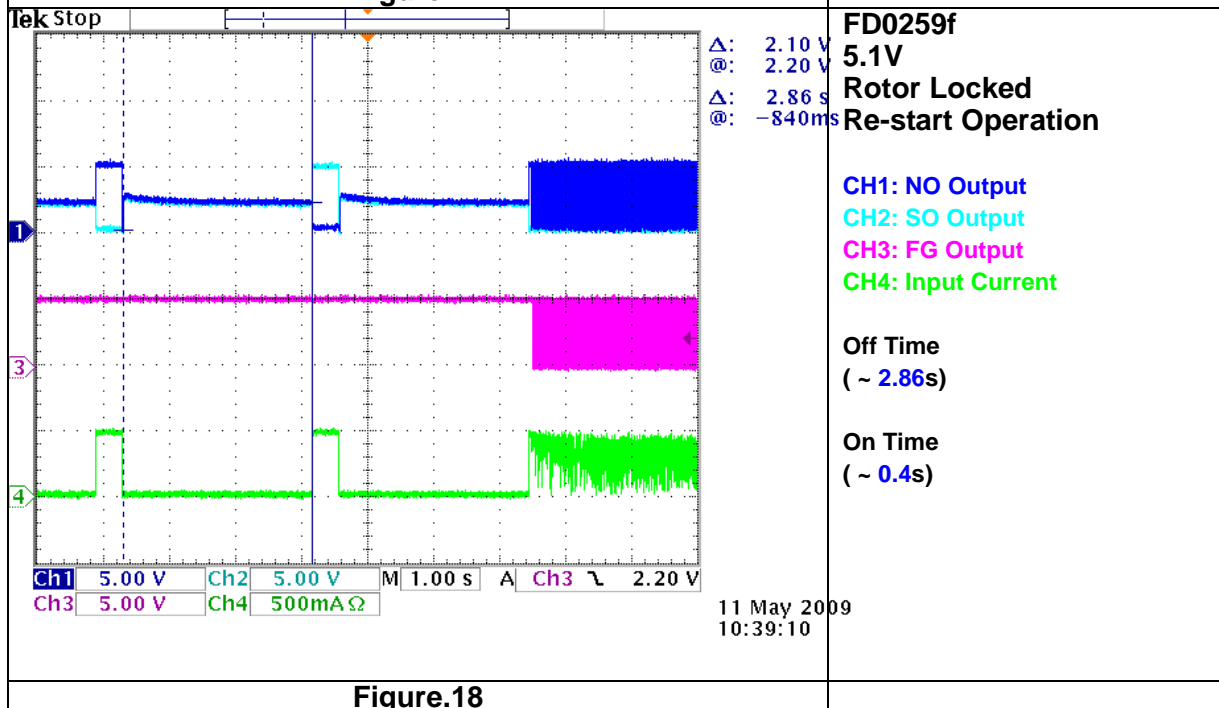
The IC laying aside mode declaration is as follows:

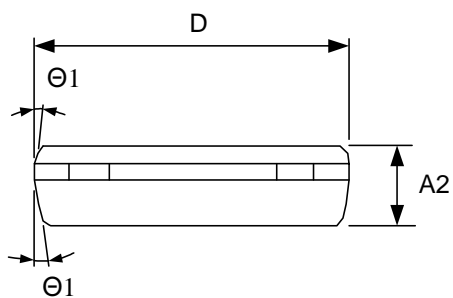
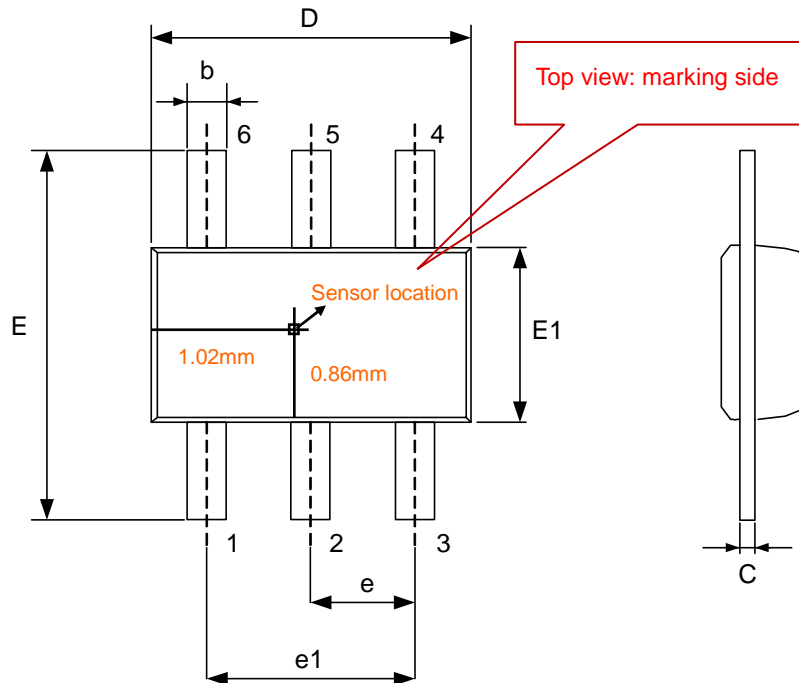

**Figure.13**

**FD0259f Output Waveforms Description**

**Figure.14**

**FD0259f Output Waveforms Measurements**

**Figure.15**

**Figure.16**



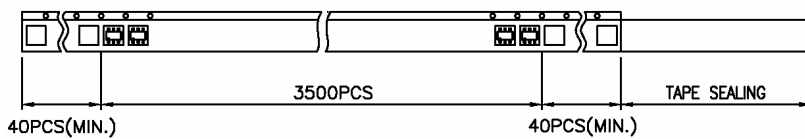
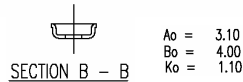
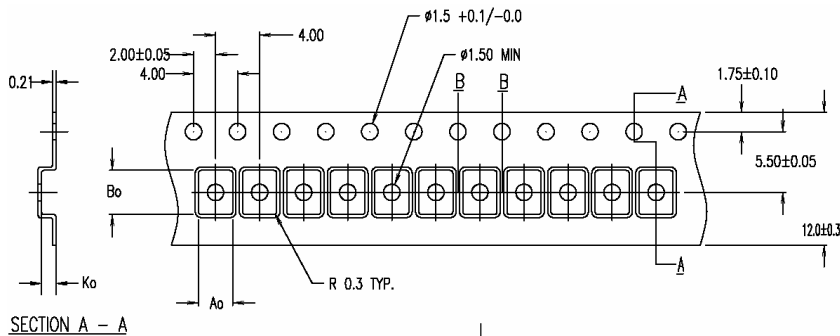
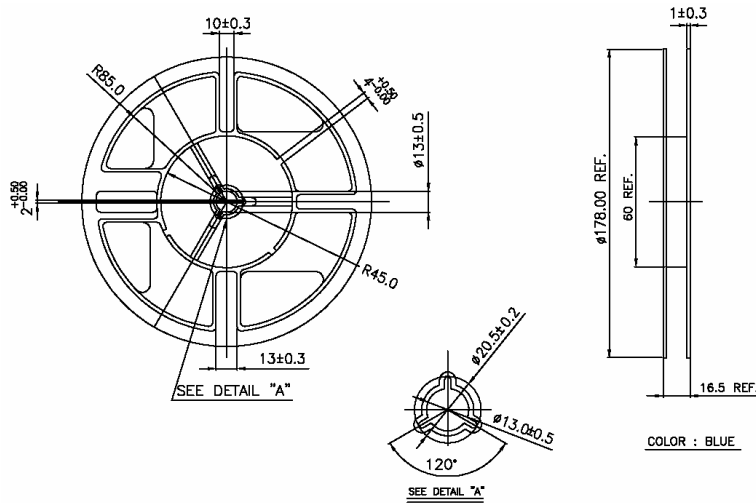
**FD0259f Output Waveforms Measurements(Conts.)**

**Figure.17**

**Figure.18**

**Package Dimension (Unit: mm)**  
**TS826 (Halogen Free)**


Symbols	Dimension In Millimeters		
	Min	Nom	Max
A2	0.700	0.750	0.775
b	0.350	-	0.500
c	0.100	-	0.200
D	2.800	2.900	3.100
E	3.700	3.800	3.900
E1	1.500	1.600	1.700
e	0.950 BSC		
e1	1.900 BSC		
θ1	4°	10°	12°



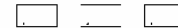
## TS826



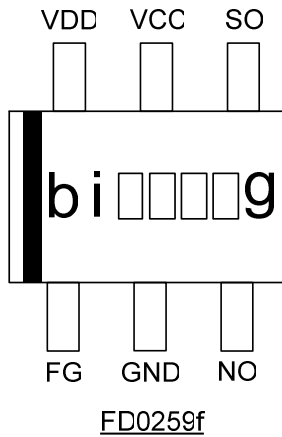
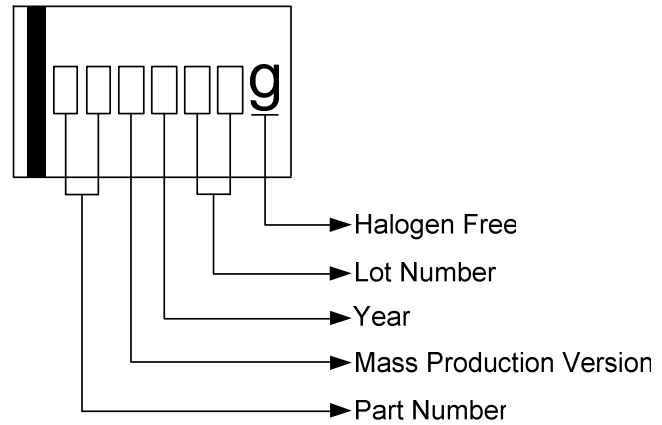
### USER DIRECTION OF FEED

1. 10 sprocket hole pitch cumulative tolerance  $\pm 0.2\text{mm}$
2. Camber not to exceed 1mm in 100mm.
3. Material: Anti-Static Black Advantek Polystyrene.
4. Ao and Bo measured on a plane 0.3mm above the bottom of the pocket.
5. Ko measured from a plane on the inside bottom of the pocket to the top surface of the carrier.
6. Pocket position relative to sprocket hole measured as true position of pocket, not pocket hole.

Top view: marking side



3/5

**IC Pin Connection**

**Marking Distinguish**

**Order Information**

Part Number	Package	MOQ	Marking	MSL
FD0259fR-G1	TS826	3,500 EA / REEL	biXXXXg	3